

es  
o  
h  
i  
a  
b  
t

# Catálogo

2024

Novos Produtos, Disponíveis até final 1º Semestre



# Ficha e Tomadas Industriais

Gama Industrial

Novos  
Produtos

soflight®

Electric

## Ficha Macho

Ligação de aperto por Parafuso



Código	Pol.	Int.(A)	Emb.	P.U.€
FTI-013-6	3P	16A	6h	100 2,80€
FTI-014-6	4P	16A	6h	100 3,25€
FTI-015-6	5P	16A	6h	60 3,90€
FTI-023-6	3P	32A	6h	60 4,05€
FTI-024-6	4P	32A	6h	60 4,65€
FTI-025-6	5P	32A	6h	60 5,45€

## Tomada Mural Fêmea

Ligação de aperto por Parafuso



Código	Pol.	Int.(A)	Emb.	P.U.€
FTI-113-6	3P	16A	6h	100 3,90€
FTI-114-6	4P	16A	6h	100 4,45€
FTI-115-6	5P	16A	6h	60 4,90€
FTI-123-6	3P	32A	6h	60 4,05€
FTI-124-6	4P	32A	6h	60 4,60€
FTI-125-6	5P	32A	6h	60 5,25€

## Ficha Fêmea

Ligação de aperto por Parafuso



Código	Pol.	Int.(A)	Emb.	P.U.€
FTI-213-6	3P	16A	6h	100 3,15€
FTI-214-6	4P	16A	6h	100 3,90€
FTI-215-6	5P	16A	6h	60 4,50€
FTI-223-6	3P	32A	6h	60 4,30€
FTI-224-6	4P	32A	6h	60 4,75€
FTI-225-6	5P	32A	6h	60 5,50€

## Tomada Encastrar Fêmea

Ligação de aperto por Parafuso



Código	Pol.	Int.(A)	Emb.	P.U.€
FTI-4130-6	3P	16A	6h	100 3,90€
FTI-4140-6	4P	16A	6h	100 5,40€
FTI-4150-6	5P	16A	6h	60 5,80€
FTI-4230-6	3P	32A	6h	60 6,40€
FTI-4240-6	4P	32A	6h	60 7,20€
FTI-4250-6	5P	32A	6h	60 7,60€

## Tomada Mural Macho

Ligação de aperto por Parafuso



Código	Pol.	Int.(A)	Emb.	P.U.€
FTI-5130-6	3P	16A	6h	100 6,80€
FTI-5140-6	4P	16A	6h	100 7,00€
FTI-5150-6	5P	16A	6h	60 7,15€
FTI-5230-6	3P	32A	6h	60 7,90€
FTI-5240-6	4P	32A	6h	60 8,90€
FTI-5250-6	5P	32A	6h	60 9,50€

## Tomada Encast. Macho

Ligação de aperto por Parafuso



Código	Pol.	Int.(A)	Emb.	P.U.€
FTI-6130-6	3P	16A	6h	100 5,00€
FTI-6140-6	4P	16A	6h	100 5,30€
FTI-6150-6	5P	16A	6h	60 5,95€
FTI-6230-6	3P	32A	6h	60 6,50€
FTI-6240-6	4P	32A	6h	60 7,90€
FTI-6250-6	5P	32A	6h	60 8,30€

## Ficha Macho

Ligação de aperto por Parafuso



Código	Pol.	Int.(A)	Emb.	P.U.€
FTI-0330-6	3P	63A	6h	100 21,00€
FTI-0340-6	4P	63A	6h	100 23,00€
FTI-0350-6	5P	63A	6h	60 25,00€
FTI-0430-6	3P	125A	6h	60 85,00€
FTI-0440-6	4P	125A	6h	60 89,00€
FTI-0450-6	5P	125A	6h	60 93,00€

## Tomada Mural Fêmea

Ligação de aperto por Parafuso

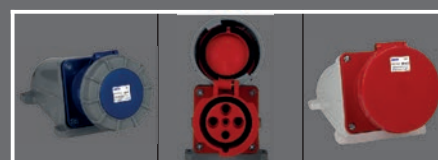

Código	Pol.	Int.(A)	Emb.	P.U.€
FTI-1330-6	3P	63A	6h	100 29,00€
FTI-1340-6	4P	63A	6h	100 30,00€
FTI-1350-6	5P	63A	6h	60 32,00€
FTI-1430-6	3P	125A	6h	60 91,00€
FTI-1440-6	4P	125A	6h	60 94,00€
FTI-1450-6	5P	125A	6h	60 99,00€

## Ficha Fêmea

Ligação de aperto por Parafuso



Código	Pol.	Int.(A)	Emb.	P.U.€
FTI-2330-6	3P	63A	6h	100 28,00€
FTI-2340-6	4P	63A	6h	100 30,00€
FTI-2350-6	5P	63A	6h	60 31,00€
FTI-2430-6	3P	125A	6h	60 90,00€
FTI-2440-6	4P	125A	6h	60 94,00€
FTI-2450-6	5P	125A	6h	60 97,00€

## Tomada Encastrar Fêmea

Ligação de aperto por Parafuso



Código	Pol.	Int.(A)	Emb.	P.U.€
FTI-3330-6	3P	63A	6h	100 24,00€
FTI-3340-6	4P	63A	6h	100 28,00€
FTI-3350-6	5P	63A	6h	60 29,00€
FTI-3430-6	3P	125A	6h	60 86,00€
FTI-3440-6	4P	125A	6h	60 89,00€
FTI-3450-6	5P	125A	6h	60 94,00€

## Tomada Encastrar Macho

Ligação de aperto por Parafuso



Código	Pol.	Int.(A)	Emb.	P.U.€
FTI-6330-6	3P	63A	6h	100 40,00€
FTI-6340-6	4P	63A	6h	100 42,00€
FTI-6350-6	5P	63A	6h	60 46,00€
FTI-6430-6	3P	125A	6h	60 169,00€
FTI-6440-6	4P	125A	6h	60 177,00€
FTI-6450-6	5P	125A	6h	60 185,00€

## Ficha Macho

Inversão de Fase



Código	Pol.	Int.(A)	Emb.	P.U.€
FTI-0151-6-T	5P	16A	6h	100 12,00€
FTI-0152-6-T	5P	32A	6h	100 15,00€

## Ficha Dupla



Código	Pol.	Int.(A)	Emb.	P.U.€
FTI-1012-2-6	3P	16A	6h 20	25,00€
FTI-1014-2-6	4P	16A	6h 20	26,00€
FTI-1015-2-6	5P	16A	6h 20	36,00€
FTI-1022-2-6	3P	32A	6h 20	37,00€
FTI-1024-2-6	4P	32A	6h 20	41,00€
FTI-1025-2-6	5P	32A	6h 20	55,00€

## Ficha Tripla



Código	Pol.	Int.(A)	Emb.	P.U.€
FTI-1013-3-6	3P	16A	6h 20	29,50€
FTI-1014-3-6	4P	16A	6h 20	30,50€
FTI-1015-3-6	5P	16A	6h 20	43,50€
FTI-1022-3-6	3P	32A	6h 20	41,00€
FTI-1024-3-6	4P	32A	6h 20	51,00€
FTI-1025-3-6	5P	32A	6h 20	53,00€

## Tomada CEE +Schuko



Código	Pol.	Int.(A)	Emb.	P.U.€
FTI-115+SCHUKO	5P	16A	6h 20	21,00€
FTI-125+SCHUKO	5P	32A	6h 20	30,00€

## Tom.c/Int.Encravamento



Código	Pol.	Int.(A)	Emb.	P.U.€
FTI-9113-6	3P	16A	6h 100	49,00€
FTI-9114-6	4P	16A	6h 100	51,00€
FTI-9115-6	5P	16A	6h 60	53,00€
FTI-9123-6	3P	32A	6h 60	56,00€
FTI-9124-6	4P	32A	6h 60	58,00€
FTI-9125-6	5P	32A	6h 60	60,00€

## Janelas p/ Caixas



Código	Nº Módulos	Emb.	P.U.€
SL-CP-J4-4B	4 M	50	15,00€
SL-CP-J4-6B	6 M	50	19,00€
SL-CP-J4-8B	8 M	50	20,00€
SL-CP-J4-12B	12 M	50	21,00€
SL-CP-J4-16B	16 M	50	30,00€

## Tomada Encastrar Schuko IP 54 -16A



Código	Pol.	Int.(A)	P.U.€
FTI-003-SCHUKO	2+T	16A	4,10€

## Ventiladores IP 54 c/Grelha e Filtro



Código	Descrição	P.U.€
SL-V-V00116	Vent.92x92x25mm c/Grelha 116,5x116,5mm 230V	32,00€
SL-V-V00148	Vent.120x120x38mm c/Grelha 148,5x148,5mm 230V	37,00€
SL-V-V00204	Vent. 172x150x51mm c/Grelha 204x204mm 230V	61,00€
SL-V-V00255	Vent. 172x150x51mm c/Grelha 255x255mm 230V	70,00€

## Grelhas c/ Filtro p/Vent. IP 54



Código	Descrição	P.U.€
SL-V-G00116	Grelha c/Filtro 116,5x116,5mm	7,00€
SL-V-G00148	Grelha c/Filtro 148,5x148,5mm	8,00€
SL-V-G00204	Grelha c/Filtro 204x204mm	15,00€
SL-V-G00255	Grelha c/Filtro 255x255mm	22,00€
SL-V-G00320	Grelha c/Filtro 320x320mm	35,00€

## Pinos Para Fichas Multipolos



Código	Descrição	P.U.€
SL-FMP-PINO-MACHO	Pino Macho de Cravar p/Ficha Multipolos	0,70€
SL-FMP-PINO-FEMEA	Pino Fêmea de Cravar p/Ficha Multipolos	0,70€
SL-FMP-ALICATE	Alicate para Cravar Pinos Multipolos	128,00€

## Ferramenta Remoção Pinos



Código	Descrição	P.U.€
SL-FMP-FERRAM-01	Ferramenta Remoção Pinos HG	80,00€
SL-FMP-FERRAM-02	Ferramenta Remoção Pinos HE	80,00€

# Pimenteiros

## Pimenteiro



Constituído por:  
6 Tom.Schuko  
6 Disj.1P 16A

Código	Alimentação	IP	P.U.€
PIM-01010	Cabo direto à Caixa ( S/Cabo )	44	140,00€

## Pimenteiro



Constituído por:  
1 Tom.CEE 3x16A  
1 Tom.CEE 5x16A  
1 Tom.CEE 5x32A  
3 Tom.Schuko  
1 I.Dif.4x40A 30mA  
1 Disj.3P 32A  
1 Disj.3P 16A  
2 Disj.1P 16A  
1 Sinal.Triplo

Código	Alimentação	IP	P.U.€
PIM-01030	Cabo direto à Caixa ( S/Cabo )	44	320,00€

## Pimenteiro



Constituído por:  
3 Tom.CEE 3x16A  
1 Tom.CEE 5x16A  
1 Tom.CEE 5x32A  
2 Tom.Schuko  
1 I.Dif.4x40A 30mA  
1 Disj.3P 32A  
1 Disj.3P 16A  
2 Disj.1P 16A

Código	Alimentação	IP	P.U.€
PIM-03010	Tomada CEE Macho 5x32A	67	425,00€

## Caixa Vazia ABS



Código	Altura	Largura	Profundidade	Nº Módulos	P.U.€
SL-07-110	260mm	150mm	120mm	6	16,00€

## Caixa Vazia ABS



Código	Altura	Largura	Profundidade	Nº Módulos	P.U.€
SL-07-220	288mm	218mm	124mm	10	23,50€

## Caixa Vazia ABS



Código	Altura	Largura	Profundidade	Nº Módulos	P.U.€
SL-07-330	288mm	280mm	130mm	12	31,00€



Constituído por:  
1 Tom.CEE 5x16A  
1 Tom.CEE 3x16A  
2 Tom.Schuko  
1 Disj.3P 32A  
3 Disj.1P 16A

Código	Alimentação	IP	P.U.€
PIM-01020	Cabo direto à Caixa ( S/Cabo )	44	125,00€



Constituído por:  
3 T.CEE 3x16A  
1 T.CEE 5x16A  
1 T.CEE 5x32A  
2 Tom.Schuko  
1 I.Dif.4x40A  
1 Disj.3P 32A  
1 Disj.3P 16A  
2 Disj.1P 16A

Código	Alimentação	IP	P.U.€
PIM-02010	Tomada CEE Macho 5x32A	44	322,00€

## Caixas Vazia para Pimenteiro



Código	Descrição	P.U.€
PIM-CX01030	Caixa Vazia para Pimenteiro	85,00€



## Caixa Vazia para Pimenteiro

Código	Descrição	P.U.€
PIM-CX-02010	Caixa Vazia p/ Piment. p/ 12 Módulos	72,00€



## Caixa Vazia para Pimenteiro

Código	Descrição	P.U.€
PIM-CX-03010	Caixa Vazia p/ Piment., p/ 24 Módulos	129,00€

# UPS



### UPS-OFF11-600VA

UPS Line-Interactive  
Monofásica - 600Va  
Bateria 12V / 1\*7AH  
230Vac / 50 Hz  
P.U. 105,00€

### UPS-OFF11-1000VA

UPS Line-Interactive  
Monofásica - 1000VA  
Bateria 12V / 2\*7AH  
230Vc / 50Hz  
P.U. 183,00€

### UPS-OFF11-2000VA

UPS Line-Interactive  
Monofásica - 2000VA  
Bateria 12V / 2\*9AH  
230Vac / 50Hz  
P.U. 255,00€



### UPS-ON11-1K

UPS Smart On-Line  
Bateria 12V / 2\*9AH  
Monofásica / Monofásica  
1000VA / 230Vac / 50Hz  
P.U. 595,00€

### UPS-ON11-2K

UPS Smart On-Line  
Bateria 12V / 4\*9AH  
Monofásica / Monofásica  
2000VA / 230Vac / 50Hz  
P.U. 865,00€

### UPS-ON11-3K

UPS Smart On-Line  
Bateria 12V / 6\*9AH  
Monofásica / Monofásica  
3000VA / 230Vac / 50Hz  
P.U. 1155,00€



### UPS-ON11-6K

UPS Smart On-Line  
Bateria 12V / 16\*7AH  
Monofásica / Monofásica  
6000VA / 230Vac / 50Hz  
P.U. 2130,00€

### UPS-ON11-10K

UPS Smart On-Line  
Bateria 12V / 16\*9AH  
Monofásica / Monofásica  
10 000VA / 230Vac / 50Hz  
P.U.2800,00€



### UPS-ON101-1K

UPS on-line p/RACK  
Bateria 12V / 2\*9AH  
Monofásica / Monofásica  
1000VA / 230Vac / 50Hz  
P.U. 750,00€

### UPS-ON101-2K

UPS on-line p/ RACK  
Bateria 12V / 4\*9AH  
Monofásica / Monofásica  
2000VA / 230Vac / 50Hz  
P.U. 1140,00€

### UPS-ON101-3K

UPS on-line p/RACK  
Bateria 12V / 6\*9AH  
Monofásica / Monofásica  
3000VA / 230Vac / 50Hz  
P.U. 1440,00€

# Ficha Multipolos

Gama Industrial

Novos  
Produtos

soflight®

Electric

## Miolo Macho



Código	Pol.	Amp.	P.U.€
SL-FMP-003M	3P-T	16A	4,20€
SL-FMP-004M	4P-T	16A	4,20€
SL-FMP-005M	5P-T	16A	8,00€
SL-FMP-007M	7P+T	16A	9,00€
SL-FMP-006M	6P	16A	7,00€
SL-FMP-010M	10P	16A	8,20€
SL-FMP-016M	16P	16A	10,70€
SL-FMP-024M	24P	16A	15,00€
SL-FMP-032M	32P	16A	23,00€
SL-FMP-048M	48P	16A	31,00€

## Miolo Fêmea

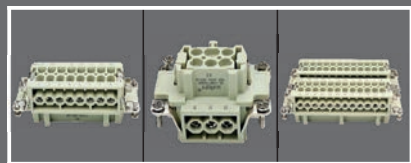

Código	Pol.	Amp.	P.U.€
SL-FMP-003F	3P-T	16A	4,20€
SL-FMP-004F	4P-T	16A	4,20€
SL-FMP-005F	5P-T	16A	8,00€
SL-FMP-007F	7P+T	16A	9,00€
SL-FMP-006F	6P	16A	7,00€
SL-FMP-010F	10P	16A	8,20€
SL-FMP-016F	16P	16A	10,70€
SL-FMP-024F	24P	16A	15,00€
SL-FMP-032F	32P	16A	23,00€
SL-FMP-048F	48P	16A	31,00€

## Base Aberta Horizontal



Código	Descrição	P.U.€
SL-003BAH	Base para 3P+T	7,00€

## Base Fechada Horiz.



Código	Descrição	P.U.€
SL-003BAH	Base para 3P+T	8,00€

## Base Extensão



Código	Descrição	P.U.€
SL-003BEH	Base p/ Exten.3P+T	8,00€

## Base Aberta Fecho Único



Código	Descrição	P.U.€
SL-003BA	Base p/ 3/4/5/7P+T	4,00€
SL-006BA1F	Base 6P,Fecho Único	8,00€
SL-010BA1F	Base 10P,Fecho Único	15,00€
SL-016BA1F	Base 16P,Fecho Único	16,00€
SL-024BA1F	Base 24P,Fecho Único	18,00€
SL-032BA1F	Base 32P,Fecho Único	28,00€
SL-048BA1F	Base 48P,Fecho Único	29,00€

## Base Aberta Fecho Duplo



Código	Descrição	P.U.€
SL-006BA2F	Base 6P,Fecho Duplo	8,00€
SL-010BA2F	Base 10P,Fecho Duplo	15,00€
SL-016BA2F	Base 16P,Fecho Duplo	16,00€
SL-024BA2F	Base 24P,Fecho Duplo	18,00€
SL-032BA2F	Base 32P,Fecho Duplo	28,00€
SL-048BA2F	Base 48P,Fecho Duplo	29,00€

## Capot Saída a Direito, Fecho Único



Código	Descrição	P.U.€
SL-003CD	Capot Saída Direito 3P+T	4,00€
SL-006C1FC	Capot Saída Direito 6P	6,00€
SL-010C1FC	Capot Saída Direito 10P	8,00€
SL-016C1FC	Capot Saída Direito 16P	10,00€
SL-024C1FC	Capot Saída Direito 24P	12,00€
SL-032C1FC	Capot Saída Direito 32P	28,00€
SL-048C1FC	Capot Saída Direito 48P	39,00€

## Capot Saída Lateral, Fecho Único



Código	Descrição	P.U.€
SL-003CL	Capot Saída Lateral 3P+T	4,00€
SL-006C1FL	Capot Saída Lateral 6P	6,00€
SL-010C1FL	Capot Saída Lateral 10P	8,00€
SL-016C1FL	Capot Saída Lateral 16P	10,00€
SL-024C1FL	Capot Saída Lateral 24P	12,00€
SL-032C1FL	Capot Saída Lateral 32P	28,00€
SL-048C1FL	Capot Saída Lateral 48P	39,00€

## Base Sali. Fecho Único



Código	Descrição	P.U.€
SL-006BS1F	Base 6P,Fecho Único	15,00€
SL-010BS1F	Base 10P,Fecho Único	22,00€
SL-016BS1F	Base 16P,Fecho Único	23,00€
SL-024BS1F	Base 24P,Fecho Único	25,00€
SL-032BS1F	Base 32P,Fecho Único	60,00€
SL-048BS1F	Base 48P,Fecho Único	75,00€

## Base Sal. Fecho Duplo



Código	Descrição	P.U.€
SL-006BS2F	Base 6P,Fecho Duplo	15,00€
SL-010BS2F	Base 10P,Fecho Duplo	22,00€
SL-016BS2F	Base 16P,Fecho Duplo	23,00€
SL-024BS2F	Base 24P,Fecho Duplo	25,00€
SL-032BS2F	Base 32P,Fecho Duplo	60,00€

## Capot Saída a Direito, Fecho Duplo



Código	Descrição	P.U.€
SL-006C2FC	Capot Saída Direito 6P	6,00€
SL-010C2FC	Capot Saída Direito 10P	8,00€
SL-016C2FC	Capot Saída Direito 16P	10,00€
SL-024C2FC	Capot Saída Direito 24P	12,00€
SL-032C2FC	Capot Saída Direito 32P	28,00€
SL-048C2FC	Capot Saída Direito 48P	39,00€

## Capot Saída Lateral, Fecho Duplo



Código	Descrição	P.U.€
SL-006C2FL	Capot Saída Lateral 6P	6,00€
SL-010C2FL	Capot Saída Lateral 10P	8,00€
SL-016C2FL	Capot Saída Lateral 16P	10,00€
SL-024C2FL	Capot Saída Lateral 24P	12,00€
SL-032C2FL	Capot Saída Lateral 32P	28,00€
SL-048C2FL	Capot Saída Lateral 48P	39,00€

### Disjuntores Automáticos Magnetotérmicos 4,5 kA (4500A)-Curva C (IEC 60898)

Gama Doméstica



Código	Pol.	Int.(A)	Emb.	P.U.€
SL-CP01106	1P	6A	12/180	1,90€
SL-CP01110	1P	10A	12/180	1,90€
SL-CP01116	1P	16A	12/180	1,90€
SL-CP01120	1P	20A	12/180	1,90€
SL-CP01125	1P	25A	12/180	1,90€
SL-CP01132	1P	32A	12/180	1,90€



Código	Pol.	Int.(A)	Emb.	P.U.€
SL-CP01506	F+N	6A	12/180	5,50€
SL-CP01510	F+N	10A	12/180	5,50€
SL-CP01516	F+N	16A	12/180	5,50€
SL-CP01520	F+N	20A	12/180	5,50€
SL-CP01525	F+N	25A	12/180	5,50€
SL-CP01532	F+N	32A	12/180	5,50€



Código	Pol.	Int.(A)	Emb.	P.U.€
SL-CP01306	3P	6A	4/60	8,70€
SL-CP01310	3P	10A	4/60	8,70€
SL-CP01316	3P	16A	4/60	8,70€
SL-CP01320	3P	20A	4/60	8,70€
SL-CP01325	3P	25A	4/60	8,70€
SL-CP01332	3P	32A	4/60	8,70€

### Disjuntores Automáticos Magnetotérmicos 6 kA (6000A)-Curva C (IEC 60898)

Gama Industrial



Código	Pol.	Int.(A)	Emb.	P.U.€
SL-CP02101	1P	1A	12/180	3,25€
SL-CP02102	1P	2A	12/180	3,25€
SL-CP02103	1P	3A	12/180	3,25€
SL-CP02104	1P	4A	12/180	3,25€
SL-CP02106	1P	6A	12/180	2,30€
SL-CP02110	1P	10A	12/180	2,30€
SL-CP02116	1P	16A	12/180	2,30€
SL-CP02120	1P	20A	12/180	2,30€
SL-CP02125	1P	25A	12/180	2,30€
SL-CP02132	1P	32A	12/180	2,30€
SL-CP02140	1P	40A	12/180	3,25€
SL-CP02150	1P	50A	12/180	3,25€
SL-CP02163	1P	63A	12/180	3,25€



Código	Pol.	Int.(A)	Emb.	P.U.€
SL-CP02301	3P	1A	4/60	11,80€
SL-CP02302	3P	2A	4/60	11,80€
SL-CP02303	3P	3A	4/60	11,80€
SL-CP02304	3P	4A	4/60	11,80€
SL-CP02306	3P	6A	4/60	9,80€
SL-CP02310	3P	10A	4/60	9,80€
SL-CP02316	3P	16A	4/60	9,80€
SL-CP02320	3P	20A	4/60	9,80€
SL-CP02325	3P	25A	4/60	9,80€
SL-CP02332	3P	32A	4/60	9,80€
SL-CP02340	3P	40A	4/60	11,80€
SL-CP02350	3P	50A	4/60	11,80€
SL-CP02363	3P	63A	4/60	11,80€



Código	Pol.	Int.(A)	Emb.	P.U.€
SL-CP02401	4P	1A	3/30	19,30€
SL-CP02402	4P	2A	3/30	19,30€
SL-CP02403	4P	3A	3/30	19,30€
SL-CP02404	4P	4A	3/30	19,30€
SL-CP02406	4P	6A	3/30	16,00€
SL-CP02410	4P	10A	3/30	16,00€
SL-CP02416	4P	16A	3/30	16,00€
SL-CP02420	4P	20A	3/30	16,00€
SL-CP02425	4P	25A	3/30	16,00€
SL-CP02432	4P	32A	3/30	16,00€
SL-CP02440	4P	40A	3/30	19,30€
SL-CP02450	4P	50A	3/30	19,30€
SL-CP02463	4P	63A	3/30	19,30€



Código	Pol.	Int.(A)	Emb.	P.U.€
SL-CP02501	F+N	1A	12/180	12,00€
SL-CP02502	F+N	2A	12/180	12,00€
SL-CP02504	F+N	4A	12/180	12,00€
SL-CP02506	F+N	6A	12/180	8,90€
SL-CP02510	F+N	10A	12/180	8,90€
SL-CP02516	F+N	16A	12/180	8,90€
SL-CP02520	F+N	20A	12/180	8,90€
SL-CP02525	F+N	25A	12/180	8,90€
SL-CP02532	F+N	32A	12/180	8,90€



Código	Pol.	Int.(A)	Emb.	P.U.€
SL-CP02201	2P	1A	6/90	8,95€
SL-CP02202	2P	2A	6/90	8,95€
SL-CP02203	2P	3A	6/90	8,95€
SL-CP02204	2P	4A	6/90	8,95€
SL-CP02206	2P	6A	6/90	7,60€
SL-CP02210	2P	10A	6/90	7,60€
SL-CP02216	2P	16A	6/90	7,60€
SL-CP02220	2P	20A	6/90	7,60€
SL-CP02225	2P	25A	6/90	7,60€
SL-CP02232	2P	32A	6/90	7,60€
SL-CP02240	2P	40A	6/90	7,60€
SL-CP02250	2P	50A	6/90	8,95€
SL-CP02263	2P	63A	6/90	8,95€

### Acessórios para Disjuntores 6KA

#### Bobine Emissão Corrente

Disparo por um Impulso de Tensão  
Largura 18mm



Código	Int.(A)	Emb.	P.U.€
SL-CP02-BD02-MX	1A	3/30	39,50€

#### Bobine de Mínima Tensão

Disparo por Dimin.ou Queda Tensão  
Largura 18mm

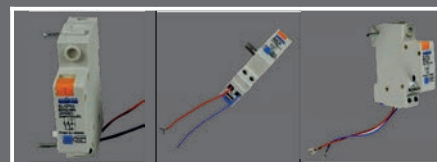

Código	Int.(A)	Emb.	P.U.€
SL-CP02-BD02-MN	1A	3/30	39,50€

### Contacto Auxiliar 1NO+1NC



Código	Int.(A)	Emb.	P.U.€
SL-CP02-AUX02-SD	1A	3/30	20,00€



# Disjuntores Magnet. Curva B e D

## Disjuntores Automáticos Magnetotérmicos 6 kA (6000A)-Curva B

Gama Industrial

(IEC 60898)



Código	Pol.	Int.(A)	Emb.	P.U.€
SL-CP02106-B	1P	6A	12/180	3,25€
SL-CP02110-B	1P	10A	12/180	3,25€
SL-CP02116-B	1P	16A	12/180	3,25€
SL-CP02120-B	1P	20A	12/180	3,25€
SL-CP02125-B	1P	25A	12/180	3,25€
SL-CP02132-B	1P	32A	12/180	3,25€
SL-CP02140-B	1P	40A	12/180	3,50€
SL-CP02150-B	1P	50A	12/180	3,50€
SL-CP02163-B	1P	63A	12/180	3,50€

Código	Pol.	Int.(A)	Emb.	P.U.€
SL-CP02206-B	2P	6A	6/90	8,60€
SL-CP02210-B	2P	10A	6/90	8,60€
SL-CP02216-B	2P	16A	6/90	8,60€
SL-CP02220-B	2P	20A	6/90	8,60€
SL-CP02225-B	2P	25A	6/90	8,60€
SL-CP02232-B	2P	32A	6/90	8,60€
SL-CP02240-B	2P	40A	6/90	9,50€
SL-CP02250-B	2P	50A	6/90	9,50€
SL-CP02263-B	2P	63A	6/90	9,50€

Código	Pol.	Int.(A)	Emb.	P.U.€
SL-CP02306-B	3P	6A	4/60	12,00€
SL-CP02310-B	3P	10A	4/60	12,00€
SL-CP02316-B	3P	16A	4/60	12,00€
SL-CP02320-B	3P	20A	4/60	12,00€
SL-CP02325-B	3P	25A	4/60	12,00€
SL-CP02332-B	3P	32A	4/60	12,00€
SL-CP02340-B	3P	40A	4/60	14,00€
SL-CP02350-B	3P	50A	4/60	14,00€
SL-CP02363-B	3P	63A	4/60	14,00€



Código	Pol.	Int.(A)	Emb.	P.U.€
SL-CP02406-B	4P	6A	3/30	22,00€
SL-CP02410-B	4P	10A	3/30	22,00€
SL-CP02416-B	4P	16A	3/30	22,00€
SL-CP02420-B	4P	20A	3/30	22,00€
SL-CP02425-B	4P	25A	3/30	22,00€
SL-CP02432-B	4P	32A	3/30	22,00€
SL-CP02440-B	4P	40A	3/30	25,00€
SL-CP02450-B	4P	50A	3/30	25,00€
SL-CP02463-B	4P	63A	3/30	25,00€



Código	Pol.	Int.(A)	Emb.	P.U.€
SL-CP02506-B	F+N	6A	12/180	14,00€
SL-CP02510-B	F+N	10A	12/180	14,00€
SL-CP02516-B	F+N	16A	12/180	14,00€
SL-CP02520-B	F+N	20A	12/180	14,00€
SL-CP02525-B	F+N	25A	12/180	14,00€
SL-CP02532-B	F+N	32A	12/180	14,00€

## Disjuntores Automáticos Magnetotérmicos 6 kA (6000A)-Curva D

Gama Industrial

(IEC 60898)



Código	Pol.	Int.(A)	Emb.	P.U.€
SL-CP02106-D	1P	6A	12/180	3,25€
SL-CP02110-D	1P	10A	12/180	3,25€
SL-CP02116-D	1P	16A	12/180	3,25€
SL-CP02120-D	1P	20A	12/180	3,25€
SL-CP02125-D	1P	25A	12/180	3,25€
SL-CP02132-D	1P	32A	12/180	3,25€
SL-CP02140-D	1P	40A	12/180	3,50€
SL-CP02150-D	1P	50A	12/180	3,50€
SL-CP02163-D	1P	63A	12/180	3,50€

Código	Pol.	Int.(A)	Emb.	P.U.€
SL-CP02206-D	2P	6A	6/90	8,60€
SL-CP02210-D	2P	10A	6/90	8,60€
SL-CP02216-D	2P	16A	6/90	8,60€
SL-CP02220-D	2P	20A	6/90	8,60€
SL-CP02225-D	2P	25A	6/90	8,60€
SL-CP02232-D	2P	32A	6/90	8,60€
SL-CP02240-D	2P	40A	6/90	9,50€
SL-CP02250-D	2P	50A	6/90	9,50€
SL-CP02263-D	2P	63A	6/90	9,50€

Código	Pol.	Int.(A)	Emb.	P.U.€
SL-CP02306-D	3P	6A	4/60	12,00€
SL-CP02310-D	3P	10A	4/60	12,00€
SL-CP02316-D	3P	16A	4/60	12,00€
SL-CP02320-D	3P	20A	4/60	12,00€
SL-CP02325-D	3P	25A	4/60	12,00€
SL-CP02332-D	3P	32A	4/60	12,00€
SL-CP02340-D	3P	40A	4/60	14,00€
SL-CP02350-D	3P	50A	4/60	14,00€
SL-CP02363-D	3P	63A	4/60	14,00€



Código	Pol.	Int.(A)	Emb.	P.U.€
SL-CP02406-D	4P	6A	3/30	22,00€
SL-CP02410-D	4P	10A	3/30	22,00€
SL-CP02416-D	4P	16A	3/30	22,00€
SL-CP02420-D	4P	20A	3/30	22,00€
SL-CP02425-D	4P	25A	3/30	22,00€
SL-CP02432-D	4P	32A	3/30	22,00€
SL-CP02440-D	4P	40A	3/30	25,00€
SL-CP02450-D	4P	50A	3/30	25,00€
SL-CP02463-D	4P	63A	3/30	25,00€



Código	Pol.	Int.(A)	Emb.	P.U.€
SL-CP02506-D	F+N	6A	12/180	14,00€
SL-CP02510-D	F+N	10A	12/180	14,00€
SL-CP02516-D	F+N	16A	12/180	14,00€
SL-CP02520-D	F+N	20A	12/180	14,00€
SL-CP02525-D	F+N	25A	12/180	14,00€
SL-CP02532-D	F+N	32A	12/180	14,00€

## Disjuntores Automáticos Magnetotérmicos 10 kA(10000A)-Curva C(IEC 60947-2)



Código	Pol.	Int.(A)	Emb.	P.U.€
SL-CP03106	1P	6A	12/180	7,05€
SL-CP03110	1P	10A	12/180	7,05€
SL-CP03116	1P	16A	12/180	7,05€
SL-CP03120	1P	20A	12/180	7,05€
SL-CP03125	1P	25A	12/180	7,05€
SL-CP03132	1P	32A	12/180	7,05€
SL-CP03140	1P	40A	12/180	8,20€
SL-CP03150	1P	50A	12/180	8,20€
SL-CP03163	1P	63A	12/180	8,20€



Código	Pol.	Int.(A)	Emb.	P.U.€
SL-CP03206	2P	6A	6/90	17,40€
SL-CP03210	2P	10A	6/90	17,40€
SL-CP03216	2P	16A	6/90	17,40€
SL-CP03220	2P	20A	6/90	17,40€
SL-CP03225	2P	25A	6/90	17,40€
SL-CP03232	2P	32A	6/90	17,40€
SL-CP03240	2P	40A	6/90	19,00€
SL-CP03250	2P	50A	6/90	19,00€
SL-CP03263	2P	63A	6/90	19,00€



Código	Pol.	Int.(A)	Emb.	P.U.€
SL-CP03306	3P	6A	4/60	24,50€
SL-CP03310	3P	10A	4/60	24,50€
SL-CP03316	3P	16A	4/60	24,50€
SL-CP03320	3P	20A	4/60	24,50€
SL-CP03325	3P	25A	4/60	24,50€
SL-CP03332	3P	32A	4/60	24,50€
SL-CP03340	3P	40A	4/60	27,50€
SL-CP03350	3P	50A	4/60	27,50€
SL-CP03363	3P	63A	4/60	27,50€



Código	Pol.	Int.(A)	Emb.	P.U.€
SL-CP03406	4P	6A	3/45	33,00€
SL-CP03410	4P	10A	3/45	33,00€
SL-CP03416	4P	16A	3/45	33,00€
SL-CP03420	4P	20A	3/45	33,00€
SL-CP03425	4P	25A	3/45	33,00€
SL-CP03432	4P	32A	3/45	33,00€
SL-CP03440	4P	40A	3/45	35,00€
SL-CP03450	4P	50A	3/45	35,00€
SL-CP03463	4P	63A	3/45	35,00€



Código	Pol.	Int.(A)	Emb.	P.U.€
SL-CP03180	1P	80A	12/180	13,00€
SL-CP031100	1P	100A	12/180	13,00€
SL-CP031125	1P	125A	12/180	13,00€

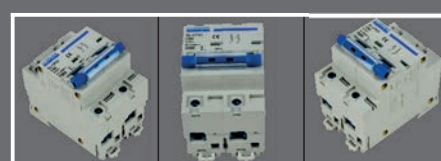

Código	Pol.	Int.(A)	Emb.	P.U.€
SL-CP03280	2P	80A	6/90	25,00€
SL-CP032100	2P	100A	6/90	25,00€
SL-CP032125	2P	125A	6/90	25,00€

### Acessórios para Disjuntores 10KA até 63A

**Bobine Emissão Corrente**  
Disparo por um Impulso de Tensão  
Largura 18mm

**Bobine de Mínima Tensão**  
Disparo p/ Dimin.ou QuedaTensão  
Largura 18mm



Código	Pol.	Int.(A)	Emb.	P.U.€
SL-CP03380	3P	80A	4/60	36,50€
SL-CP033100	3P	100A	4/60	37,10€
SL-CP033125	3P	125A	4/60	40,20€



Código	Pol.	Emb.	P.U.€
SL-CP03-AUX03-MX	1P	3/30	41,90€



Código	Pol.	Emb.	P.U.€
SL-CP03-AUX03-MN	1P	3/30	41,90€

### Contacto Auxiliar 1NO-1NC

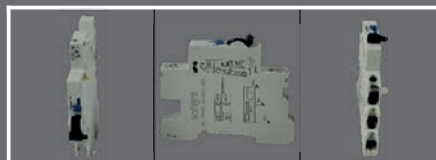

Código	Pol.	Emb.	P.U.€
SL-CP03-BD03-SD	1P	3/30	20,30€



Código	Pol.	Int.(A)	Emb.	P.U.€
SL-CP03480	4P	80A	3/45	44,70€
SL-CP034100	4P	100A	3/45	48,95€
SL-CP034125	4P	125A	3/45	54,50€

### Acessórios para Disjuntores 10KA (80 a 125A)

**Bobine Emissão Corrente**  
Disparo por Impulso de Tensão  
Largura 18mm

**Bobine de Mínima Tensão**  
Disparo por Dimin./QuedaTensão  
Largura 18mm

**Contacto Auxiliar 1NO+1NC**



Código	Pol.	Emb.	P.U.€
SL-CP02-BD02-MX	1P	3/30	39,50€

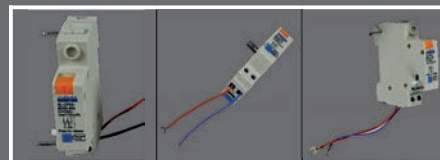

Código	Pol.	Emb.	P.U.€
SL-CP02-BD02-MN	1P	3/30	39,50€



Código	Pol.	Emb.	P.U.€
SL-CP02-AUX02-SD	1P	3/30	20,00€

# Disjuntores Magnetotérmicos

Gama Industrial

**soflight**®

Electric

## Disjuntores Automáticos Magnetotérmicos 15 kA-Curva C

(IEC 60947-2)



Código	Pol.	Int.(A)	Emb.	P.U.€
SL-CP04106	1P	6A	12/180	24,50€
SL-CP04110	1P	10A	12/180	24,00€
SL-CP04116	1P	16A	12/180	24,00€
SL-CP04120	1P	20A	12/180	24,50€
SL-CP04125	1P	25A	12/180	24,50€
SL-CP04132	1P	32A	12/180	26,50€
SL-CP04140	1P	40A	12/180	31,00€
SL-CP04150	1P	50A	12/180	40,00€
SL-CP04163	1P	63A	12/180	40,00€



Código	Pol.	Int.(A)	Emb.	P.U.€
SL-CP04206	2P	6A	6/90	46,70€
SL-CP04210	2P	10A	6/90	46,00€
SL-CP04216	2P	16A	6/90	46,00€
SL-CP04220	2P	20A	6/90	46,50€
SL-CP04225	2P	25A	6/90	46,50€
SL-CP04232	2P	32A	6/90	48,90€
SL-CP04240	2P	40A	6/90	58,00€
SL-CP04250	2P	50A	6/90	77,00€
SL-CP04263	2P	63A	6/90	83,00€



Código	Pol.	Int.(A)	Emb.	P.U.€
SL-CP04306	3P	6A	4/60	76,00€
SL-CP04310	3P	10A	4/60	72,50€
SL-CP04316	3P	16A	4/60	72,50€
SL-CP04320	3P	20A	4/60	73,00€
SL-CP04325	3P	25A	4/60	74,00€
SL-CP04332	3P	32A	4/60	77,00€
SL-CP04340	3P	40A	4/60	79,00€
SL-CP04350	3P	50A	4/60	97,00€
SL-CP04363	3P	63A	4/60	127,50€



Código	Pol.	Int.(A)	Emb.	P.U.€
SL-CP04406	4P	6A	3/45	101,00€
SL-CP04410	4P	10A	3/45	96,00€
SL-CP04416	4P	16A	3/45	96,00€
SL-CP04420	4P	20A	3/45	97,00€
SL-CP04425	4P	25A	3/45	98,00€
SL-CP04432	4P	32A	3/45	103,00€
SL-CP04440	4P	40A	3/45	121,00€
SL-CP04450	4P	50A	3/45	155,00€
SL-CP04463	4P	63A	3/45	170,00€

## Blocos Diferenciais 15kA



Código	Pol.Int.(A)	P.U.€
SL-CP04206DF-30-A	2P 6A	110,00€
SL-CP04210DF-30-A	2P 10A	110,00€
SL-CP04216DF-30-A	2P 16A	110,00€
SL-CP04220DF-30-A	2P 20A	110,00€
SL-CP04225DF-30-A	2P 25A	110,00€
SL-CP04232DF-30-A	2P 32A	120,00€
SL-CP04240DF-30-A	2P 40A	120,00€
SL-CP04250DF-30-A	2P 50A	160,00€
SL-CP04263DF-30-A	2P 63A	160,00€

## Acessórios para Disjuntores 15KA até 63A

### Bobine Emissão Corrente

Disparo por um Impulso de Tensão  
Largura 18mm



Código	Descrição	P.U.€
SL-CP04-MX-L-60V	Bobine MX+OF Aplicação Direita 24-60Vac	46,00€
SL-CP04-MX-R-60R	Bobine MX+OF Aplicação Esquerda 24-60Vac	46,00€

### Bobine de Mínima Tensão

Disparo p/ Dimin.ou Queda Tensão  
Largura 18mm



Código	Descrição	P.U.€
SL-CP04-MN-L-12V	Bobine MX+OF Aplicação Direita 12V	49,00€
SL-CP04-MN-R-12R	Bobine MX+OF Aplicação Esquerda 12V	49,00€
SL-CP04-MN-L-230V	Bobine MX+OF Aplicação Direita 230Vac	49,00€
SL-CP04-MN-R-230R	Bobine MX+OF Aplicação Esquerda 230Vac	49,00€

## Contacto Auxiliar 1NO-1NC



Código	Descrição	Pol.	P.U.€
SL-CP04-OF	Contacto Auxiliar	1P	22,00€
SL-CP04-SD	Contacto Auxiliar	1P	22,00€

## Blocos Diferenciais 15kA



Código	Pol.Int.(A)	P.U.€
SL-CP04406DF-30-A	4P 6A	130,00€
SL-CP04410DF-30-A	4P 10A	130,00€
SL-CP04416DF-30-A	4P 16A	130,00€
SL-CP04420DF-30-A	4P 20A	130,00€
SL-CP04425DF-30-A	4P 25A	130,00€
SL-CP04432DF-30-A	4P 32A	140,00€
SL-CP04440DF-30-A	4P 40A	140,00€
SL-CP04450DF-30-A	4P 50A	195,00€
SL-CP04463DF-30-A	4P 63A	195,00€

### Disjuntores Automáticos Magnetotérmicos 6 kA(6000A)-500Vdc (IEC 60947-2)



Código	Pol.	Int.(A)	Emb.	P.U.€
SL-CP02106-DC	1P	6A	12/180	6,50€
SL-CP02110-DC	1P	10A	12/180	6,50€
SL-CP02116-DC	1P	16A	12/180	6,50€
SL-CP02120-DC	1P	20A	12/180	6,50€
SL-CP02125-DC	1P	25A	12/180	6,50€
SL-CP02132-DC	1P	32A	12/180	6,90€
SL-CP02140-DC	1P	40A	12/180	6,90€
SL-CP02150-DC	1P	50A	12/180	7,50€
SL-CP02163-DC	1P	63A	12/180	7,50€



Código	Pol.	Int.(A)	Emb.	P.U.€
SL-CP02206-DC	2P	6A	6/90	12,50€
SL-CP02210-DC	2P	10A	6/90	12,50€
SL-CP02216-DC	2P	16A	6/90	12,50€
SL-CP02220-DC	2P	20A	6/90	12,50€
SL-CP02225-DC	2P	25A	6/90	12,50€
SL-CP02232-DC	2P	32A	6/90	12,95€
SL-CP02240-DC	2P	40A	6/90	12,95€
SL-CP02250-DC	2P	50A	6/90	14,00€
SL-CP02263-DC	2P	63A	6/90	14,00€

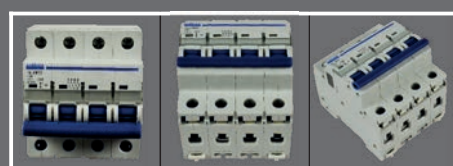

Código	Pol.	Int.(A)	Emb.	P.U.€
SL-CP02406-DC	4P	6A	3/45	27,00€
SL-CP02410-DC	4P	10A	3/45	27,00€
SL-CP02416-DC	4P	16A	3/45	27,00€
SL-CP02420-DC	4P	20A	3/45	27,00€
SL-CP02425-DC	4P	25A	3/45	27,00€
SL-CP02432-DC	4P	32A	3/45	29,00€
SL-CP02440-DC	4P	40A	3/45	30,00€
SL-CP02450-DC	4P	50A	3/45	30,00€
SL-CP02463-DC	4P	63A	3/45	30,00€



Código	Pol.	Int.(A)	Emb.	P.U.€
SL-CP02180-DC	1P	80A	12/120	21,00€
SL-CP02100-DC	1P	100A	12/120	21,00€
SL-CP02125-DC	1P	125A	12/120	21,00€



Código	Pol.	Int.(A)	Emb.	P.U.€
SL-CP02280-DC	2P	80A	3/60	35,00€
SL-CP022100-DC	2P	100A	3/60	35,00€
SL-CP022125-DC	2P	125A	3/60	35,00€



Código	Pol.	Int.(A)	Emb.	P.U.€
SL-CP02480-DC	4P	80A	3/30	69,90€
SL-CP024100-DC	4P	100A	3/30	69,90€
SL-CP024125-DC	4P	125A	3/30	69,90€

### Limitador Sobre tensão em DC (IEC61643.1)

Gama Terciária e Industrial



- \* Tipo: 2
- \* Numero Polos:2
- \* Voltagem Max.: 500/600Vdc
- \* Corrente: Mínima Descarga: 20kA  
Máxima Descarga: 40kA
- \* Nivel Protecção Tensão 1,8kV
- \* Temper. Trabalho: -40 a 80°C

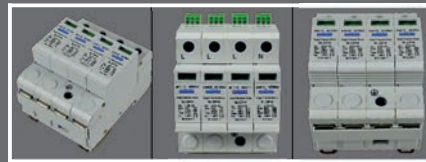

- \* Tipo: 2
- \* Numero Polos: 3
- \* Voltagem Max.: 1000Vdc
- \* Corrente: Mínima Descarga: 20kA  
Máxima Descarga: 40kA
- \* Nivel Protecção Tensão 1,8kV
- \* Temper. Trabalho: -40 a 80°C

Código	Numero Modulos	Descrição	P.U.€
SL-CP14240KA-DC	2P	20-40KA 500/600Vdc T2	55,00€

Código	Numero Modulos	Descrição	P.U.€
SL-CP14340KA-DC	3P	20-40KA 1000Vdc T2	102,00€



Código	Descrição	P.U.€
SL-CP-MC4-M	Ficha Macho Simples	1,25€
SL-CP-MC4-Y2-M	Ficha Macho Simples em Y	4,75€
SL-CP-MC4-T2-M	Ficha Macho Dupla em T	4,75€
SL-CP-MC4-T3-M	Ficha Macho Tripla em T	8,00€
SL-CP-MV4-T4-M	Ficha Macho Quádrupla em T	10,00€



Código	Descrição	P.U.€
SL-CP-MC4-F	Ficha Fêmea Simples	1,25€
SL-CP-MC4-Y2-F	Ficha Fêmea Simples em Y	4,75€
SL-CP-MC4-T2-F	Ficha Fêmea Dupla em T	4,75€
SL-CP-MC4-T3-F	Ficha Fêmea Tripla em T	8,00€
SL-CP-MV4-T4-F	Ficha Fêmea Quádrupla em T	10,00€

### Alicate de Cravar para Ficha MC4



Código	Descrição	P.U.€
SL-CP-MC4-TOOLS	Alicate de Cravar para Ficha MC4	33,00€

### Kit Ferramenta para Ficha MC4



Código	Descrição	P.U.€
SL-CP-MC4-KIT-TOOLS	Ferramenta para Ficha MC4	90,00€

## Fusíveis Cilíndricos em DC (IEC60269)



Novos Podutos

Código	Fusível	Int.(A)	Emb.	P.U.€
SL-CP10X38-02A-DC	10x38	2A	10un.	3,65€
SL-CP10X38-04A-DC	10x38	4A	10un.	3,65€
SL-CP10X38-06A-DC	10x38	6A	10un.	3,65€
SL-CP10X38-08A-DC	10x38	8A	10un.	3,65€
SL-CP10X38-10A-DC	10x38	10A	10un.	3,65€
SL-CP10X38-12A-DC	10x38	12A	10un.	3,65€
SL-CP10X38-16A-DC	10x38	16A	10un.	3,65€
SL-CP10X38-20A-DC	10x38	20A	10un.	3,65€
SL-CP10X38-25A-DC	10x38	25A	10un.	3,65€
SL-CP10X38-32A-DC	10x38	32A	10un.	3,65€

## Bases Porta-Fusíveis em DC (IEC 60947-2)



Código	Descrição	Nº Pol	Tipo Fusível	Emb.	P.U.€
SL-CP07101-DC	Base Porta- Fusível 1P	10x38	12/192	3,35€	
SL-CP07102-DC	Base Porta- Fusível 2P	10x38	6/90	8,35€	
SL-CP07103-DC	Base Porta- Fusível 3P	10x38	4/60	12,50€	

Novos Podutos

## Fusível de Facas NH 00 em DC (IEC60269)



Novos Podutos

Código	Fusível	Int.(A)	Emb.	P.U.€
SL-CP-NH00-50A-DC	NH 00	50A	10un.	28,00€
SL-CP-NH00-63A-DC	NH 00	63A	10un.	31,00€
SL-CP-NH00-80A-DC	NH 00	80A	10un.	35,00€
SL-CP-NH00-100A-DC	NH 00	100A	10un.	39,80€
SL-CP-NH00-125A-DC	NH 00	125A	10un.	43,50€

## Fusível de Facas NH 1 em DC (IEC60269)

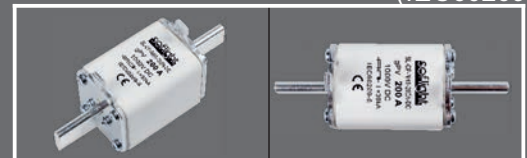

Código	Fusível	Int.(A)	Emb.	P.U.€
SL-CP-NH1-80A-DC	NH 1	80A	10un.	42,00€
SL-CP-NH1-100A-DC	NH 1	100A	10un.	45,00€
SL-CP-NH1-125A-DC	NH 1	125A	10un.	50,00€
SL-CP-NH1-160A-DC	NH 1	160A	10un.	59,00€
SL-CP-NH1-200A-DC	NH 1	200A	10un.	65,00€

## Fusível de Facas NH 2 em DC (IEC60269)



Novos Podutos

Código	Fusível	Int.(A)	Emb.	P.U.€
SL-CP-NH2-200A-DC	NH 2	200A	10un.	78,00€
SL-CP-NH2-250A-DC	NH 2	250A	10un.	90,00€
SL-CP-NH2-315A-DC	NH 2	315A	10un.	103,00€

## Fusível de Facas NH 3 em DC (IEC60269)



Código	Fusível	Int.(A)	Emb.	P.U.€
SL-CP-NH3-315A-DC	NH 3	315A	10un.	115,00€
SL-CP-NH3-400A-DC	NH 3	400A	10un.	125,00€
SL-CP-NH3-500A-DC	NH 3	500A	10un.	140,00€

## Base NH...1000Vdc (IEC60269)



Novos Podutos

Código	P/Fusível	Int.(A)	Emb.	P.U.€
SL-CP07-NH00-DC	NH 00	125A	10un.	8,50€
SL-CP07-NH1-DC	NH 1	200A	10un.	35,30€
SL-CP07-NH2-DC	NH 2	315A	10un.	45,50€
SL-CP07-NH3-DC	NH 3	500A	10un.	62,50€

## Inversor 32A 1000Vdc



Código	Numero Modulos	Descrição	P.U.€
SL-CP-63-432-DC	4P	Inversor 32A 1000Vdc IP65	80,00€

### Fusível de Facas NH 00 gG 500/660 Vac

(IEC60269)

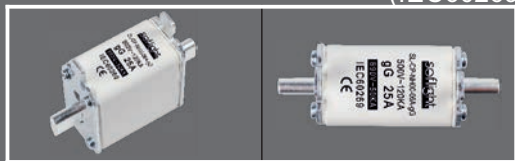

Novos Podutos

Código	Fusível	Int.(A)	Qt.Min. Venda	P.U.€
SL-CP-NH00-06A-gG	NH 00	6A	5 pcs	5,20€
SL-CP-NH00-10A-gG	NH 00	10A	5 pcs	5,20€
SL-CP-NH00-16A-gG	NH 00	16A	5 pcs	5,20€
SL-CP-NH00-20A-gG	NH 00	20A	5 pcs	5,20€
SL-CP-NH00-25A-gG	NH 00	25A	5 pcs	4,90€
SL-CP-NH00-32A-gG	NH 00	32A	5 pcs	4,90€
SL-CP-NH00-40A-gG	NH 00	40A	5 pcs	4,90€
SL-CP-NH00-50A-gG	NH 00	50A	5 pcs	4,90€
SL-CP-NH00-63A-gG	NH 00	63A	5 pcs	4,90€
SL-CP-NH00-80A-gG	NH 00	80A	5 pcs	4,90€
SL-CP-NH00-100A-gG	NH 00	100A	5 pcs	4,90€
SL-CP-NH00-125A-gG	NH 00	125A	5 pcs	5,20€
SL-CP-NH00-160A-gG	NH 00	160A	5 pcs	5,20€

### Fusível de Facas NH 00 aM 500/660 Vac

(IEC60269)

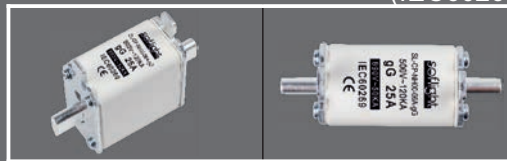

Novos Podutos

Código	Fusível	Int.(A)	Qt.Min. Venda	P.U.€
SL-CP-NH00-06A-aM	NH 00	6A	5 pcs	7,50€
SL-CP-NH00-10A-aM	NH 00	10A	5 pcs	7,50€
SL-CP-NH00-16A-aM	NH 00	16A	5 pcs	7,50€
SL-CP-NH00-20A-aM	NH 00	20A	5 pcs	7,50€
SL-CP-NH00-25A-aM	NH 00	25A	5 pcs	6,50€
SL-CP-NH00-32A-aM	NH 00	32A	5 pcs	6,50€
SL-CP-NH00-40A-aM	NH 00	40A	5 pcs	6,50€
SL-CP-NH00-50A-aM	NH 00	50A	5 pcs	6,50€
SL-CP-NH00-63A-aM	NH 00	63A	5 pcs	6,50€
SL-CP-NH00-80A-aM	NH 00	80A	5 pcs	6,50€
SL-CP-NH00-100A-aM	NH 00	100A	5 pcs	6,50€
SL-CP-NH00-125A-aM	NH 00	125A	5 pcs	7,50€
SL-CP-NH00-160A-aM	NH 00	160A	5 pcs	7,50€

### Fusível de Facas NH 1 gG 500/660 Vac

(IEC60269)

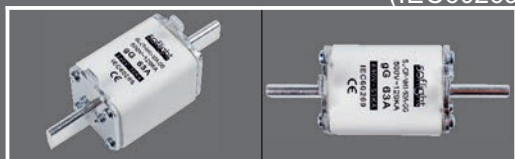

Novos Podutos

Código	Fusível	Int.(A)	Qt.Min. Venda	P.U.€
SL-CP-NH1-50A-gG	NH 1	50A	3 pcs	9,00€
SL-CP-NH1-63A-gG	NH 1	63A	3 pcs	9,00€
SL-CP-NH1-80A-gG	NH 1	80A	3 pcs	9,00€
SL-CP-NH1-100A-gG	NH 1	100A	3 pcs	9,00€
SL-CP-NH1-125A-gG	NH 1	125A	3 pcs	9,00€
SL-CP-NH1-160A-gG	NH 1	160A	3 pcs	9,00€
SL-CP-NH1-200A-gG	NH 1	200A	3 pcs	13,00€
SL-CP-NH1-224A-gG	NH 1	224A	3 pcs	13,00€
SL-CP-NH1-250A-gG	NH 1	250A	3 pcs	14,00€

### Fusível de Facas NH 1 aM 500/660 Vac

(IEC60269)



Novos Podutos

Código	Fusível	Int.(A)	Qt.Min. Venda	P.U.€
SL-CP-NH1-50A-aM	NH 1	50A	3 pcs	15,00€
SL-CP-NH1-63A-aM	NH 1	63A	3 pcs	15,00€
SL-CP-NH1-80A-aM	NH 1	80A	3 pcs	15,00€
SL-CP-NH1-100A-aM	NH 1	100A	3 pcs	15,00€
SL-CP-NH1-125A-aM	NH 1	125A	3 pcs	15,00€
SL-CP-NH1-160A-aM	NH 1	160A	3 pcs	15,00€
SL-CP-NH1-200A-aM	NH 1	200A	3 pcs	16,00€
SL-CP-NH1-224A-aM	NH 1	224A	3 pcs	16,00€
SL-CP-NH1-250A-aM	NH 1	250A	3 pcs	17,00€

### Fusível de Facas NH 2 gG 500/660 Vac

(IEC60269)



Novos Podutos

Código	Fusível	Int.(A)	Qt.Min. Venda	P.U.€
SL-CP-NH2-63A-gG	NH 2	63A	3 pcs	15,50€
SL-CP-NH2-80A-gG	NH 2	80A	3 pcs	15,50€
SL-CP-NH2-100A-gG	NH 2	100A	3 pcs	15,50€
SL-CP-NH2-125A-gG	NH 2	125A	3 pcs	15,50€
SL-CP-NH2-160A-gG	NH 2	160A	3 pcs	15,50€
SL-CP-NH2-200A-gG	NH 2	200A	3 pcs	15,50€
SL-CP-NH2-224A-gG	NH 2	224A	3 pcs	15,50€
SL-CP-NH2-250A-gG	NH 2	250A	3 pcs	15,50€
SL-CP-NH2-315A-gG	NH 2	315A	3 pcs	19,50€
SL-CP-NH2-355A-gG	NH 2	355A	3 pcs	19,50€
SL-CP-NH2-400A-gG	NH 2	400A	3 pcs	22,50€

### Fusível de Facas NH 2 aM 500/660 Vac

(IEC60269)



Novos Podutos

Código	Fusível	Int.(A)	Qt.Min. Venda	P.U.€
SL-CP-NH2-63A-aM	NH 2	63A	3 pcs	22,00€
SL-CP-NH2-80A-aM	NH 2	80A	3 pcs	22,00€
SL-CP-NH2-100A-aM	NH 2	100A	3 pcs	22,00€
SL-CP-NH2-125A-aM	NH 2	125A	3 pcs	22,00€
SL-CP-NH2-160A-aM	NH 2	160A	3 pcs	22,00€
SL-CP-NH2-200A-aM	NH 2	200A	3 pcs	22,00€
SL-CP-NH2-224A-aM	NH 2	224A	3 pcs	22,00€
SL-CP-NH2-250A-aM	NH 2	250A	3 pcs	26,00€
SL-CP-NH2-315A-aM	NH 2	315A	3 pcs	26,00€
SL-CP-NH2-355A-aM	NH 2	355A	3 pcs	28,00€
SL-CP-NH2-400A-aM	NH 2	400A	3 pcs	29,00€

Novos  
Produtos

## Fusível de Facas NH 3 gG

500/660 Vac

(IEC60269)

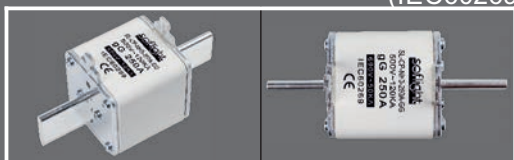

Código	Fusível	Int.(A)	Qt.Min. Venda	P.U.€
SL-CP-NH3-250A-gG	NH 3	250A	3 pcs	25,00€
SL-CP-NH3-315A-gG	NH 3	315A	3 pcs	25,00€
SL-CP-NH3-355A-gG	NH 3	355A	3 pcs	25,00€
SL-CP-NH3-400A-gG	NH 3	400A	3 pcs	25,00€
SL-CP-NH3-500A-gG	NH 3	500A	3 pcs	40,00€
SL-CP-NH3-630A-gG	NH 3	630A	3 pcs	43,00€

Novos  
Produtos

## Fusível de Facas NH 3 aM

500/660 Vac

(IEC60269)

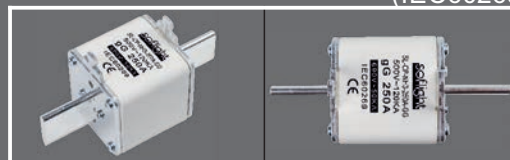

Código	Fusível	Int.(A)	Qt.Min. Venda	P.U.€
SL-CP-NH3-250A-aM	NH 3	250A	3 pcs	35,00€
SL-CP-NH3-315A-aM	NH 3	315A	3 pcs	35,00€
SL-CP-NH3-355A-aM	NH 3	355A	3 pcs	35,00€
SL-CP-NH3-400A-aM	NH 3	400A	3 pcs	35,00€
SL-CP-NH3-500A-aM	NH 3	500A	3 pcs	49,00€
SL-CP-NH3-630A-aM	NH 3	630A	3 pcs	49,00€

Novos  
Produtos

## Fusível de Facas NH 4 gG

500/660 Vac

(IEC60269)

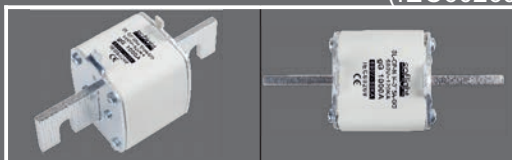

Código	Fusível	Int.(A)	Emb.	P.U.€
SL-CP-NH4-315A-gG	NH 4	315A	1 pcs	103,00€
SL-CP-NH4-400A-gG	NH 4	400A	1 pcs	103,00€
SL-CP-NH4-500A-gG	NH 4	500A	1 pcs	103,00€
SL-CP-NH4-630A-gG	NH 4	630A	1 pcs	103,00€
SL-CP-NH4-800A-gG	NH 4	800A	1 pcs	103,00€
SL-CP-NH4-900A-gG	NH 4	900A	1 pcs	103,00€
SL-CP-NH4-1000A-gG	NH 4	1000A	1 pcs	105,00€
SL-CP-NH4-1250A-gG	NH 4	1250A	1 pcs	105,00€

Novos  
Produtos

## Fusível de Facas NH 4 aM

500/660 Vac

(IEC60269)



Código	Fusível	Int.(A)	Emb.	P.U.€
SL-CP-NH4-315A-aM	NH 4	315A	1 pcs	135,00€
SL-CP-NH4-400A-aM	NH 4	400A	1 pcs	135,00€
SL-CP-NH4-500A-aM	NH 4	500A	1 pcs	135,00€
SL-CP-NH4-630A-aM	NH 4	630A	1 pcs	145,00€
SL-CP-NH4-800A-aM	NH 4	800A	1 pcs	145,00€
SL-CP-NH4-900A-aM	NH 4	900A	1 pcs	145,00€
SL-CP-NH4-1000A-aM	NH 4	1000A	1 pcs	149,00€
SL-CP-NH4-1250A-aM	NH 4	1250A	1 pcs	149,00€

Novos  
Produtos

## Base NH...690Vac

(IEC60269)

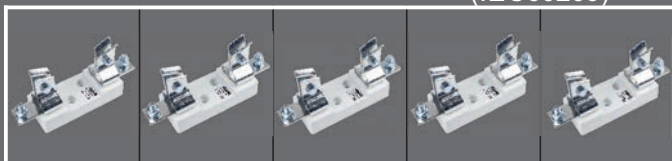

Código	P/Fusível	Int.(A)	Emb.	P.U.€
SL-CP07-NH00	NH 00	160A	3un.	6,50€
SL-CP07-NH1	NH 1	250A	1un.	18,50€
SL-CP07-NH2	NH 2	400A	1un.	33,50€
SL-CP07-NH3	NH 3	630A	1un.	39,50€
SL-CP07-NH4	NH 4	1250A	1un.	132,50€

Novos  
Produtos

## Base Neutro NH...690Vac

(IEC60269)



Código	P/Neutro	Int.(A)	Emb.	P.U.€
SL-CP07-NH00-N	NH 00	160A	3un.	9,60€
SL-CP07-NH1-N	NH 1	250A	1un.	28,50€
SL-CP07-NH2-N	NH 2	400A	1un.	37,50€

### Fusíveis Cilíndricos (IEC60269)



Código	Fusível	Int.(A)	Emb.	P.U.€
SL-CP10X38-02A-gG	10x38	2A	10un.	0,28€
SL-CP10X38-04A-gG	10x38	4A	10un.	0,28€
SL-CP10X38-06A-gG	10x38	6A	10un.	0,28€
SL-CP10X38-08A-gG	10x38	8A	10un.	0,28€
SL-CP10X38-10A-gG	10x38	10A	10un.	0,28€
SL-CP10X38-12A-gG	10x38	12A	10un.	0,28€
SL-CP10X38-16A-gG	10x38	16A	10un.	0,28€
SL-CP10X38-20A-gG	10x38	20A	10un.	0,28€
SL-CP10X38-25A-gG	10x38	25A	10un.	0,28€
SL-CP10X38-32A-gG	10x38	32A	10un.	0,28€

### Fusíveis Cilíndricos (IEC60269)



Código	Fusível	Int.(A)	Emb.	P.U.€
SL-CP10X38-02A-AM	10x38	2A	10un.	0,28€
SL-CP10X38-04A-AM	10x38	4A	10un.	0,28€
SL-CP10X38-06A-AM	10x38	6A	10un.	0,28€
SL-CP10X38-08A-AM	10x38	8A	10un.	0,28€
SL-CP10X38-10A-AM	10x38	10A	10un.	0,28€
SL-CP10X38-12A-AM	10x38	12A	10un.	0,28€
SL-CP10X38-16A-AM	10x38	16A	10un.	0,28€
SL-CP10X38-20A-AM	10x38	20A	10un.	0,28€
SL-CP10X38-25A-AM	10x38	25A	10un.	0,28€
SL-CP10X38-32A-AM	10x38	32A	10un.	0,28€



Código	Fusível	Int.(A)	Emb.	P.U.€
SL-CP14X51-10A-gG	14x51	10A	10un.	0,75€
SL-CP14X51-12A-gG	14x51	12A	10un.	0,75€
SL-CP14X51-16A-gG	14x51	16A	10un.	0,75€
SL-CP14X51-20A-gG	14x51	20A	10un.	0,75€
SL-CP14X51-25A-gG	14x51	25A	10un.	0,75€
SL-CP14X51-32A-gG	14x51	32A	10un.	0,75€
SL-CP14X51-40A-gG	14x51	40A	10un.	0,75€
SL-CP14X51-50A-gG	14x51	50A	10un.	0,75€
SL-CP14X51-63A-gG	14x51	63A	10un.	0,75€

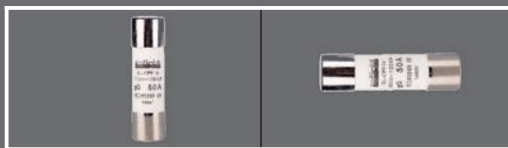

Código	Fusível	Int.(A)	Emb.	P.U.€
SL-CP14X51-10A-AM	14x51	10A	10un.	0,75€
SL-CP14X51-12A-AM	14x51	12A	10un.	0,75€
SL-CP14X51-16A-AM	14x51	16A	10un.	0,75€
SL-CP14X51-20A-AM	14x51	20A	10un.	0,75€
SL-CP14X51-25A-AM	14x51	25A	10un.	0,75€
SL-CP14X51-32A-AM	14x51	32A	10un.	0,75€
SL-CP14X51-40A-AM	14x51	40A	10un.	0,75€
SL-CP14X51-50A-AM	14x51	50A	10un.	0,75€
SL-CP14X51-63A-AM	14x51	63A	10un.	0,75€



Código	Fusível	Int.(A)	Emb.	P.U.€
SL-CP22X58-10A-gG	22x58	10A	10un.	1,20€
SL-CP22X58-16A-gG	22x58	16A	10un.	1,20€
SL-CP22X58-20A-gG	22x58	20A	10un.	1,20€
SL-CP22X58-25A-gG	22x58	25A	10un.	1,20€
SL-CP22X58-32A-gG	22x58	32A	10un.	1,20€
SL-CP22X58-40A-gG	22x58	40A	10un.	1,20€
SL-CP22X58-50A-gG	22x58	50A	10un.	1,20€
SL-CP22X58-63A-gG	22x58	63A	10un.	1,20€
SL-CP22X58-80A-gG	22x58	80A	10un.	1,20€
SL-CP22X58-100A-gG	22x58	100A	10un.	1,20€
SL-CP22X58-125A-gG	22x58	125A	10un.	1,20€

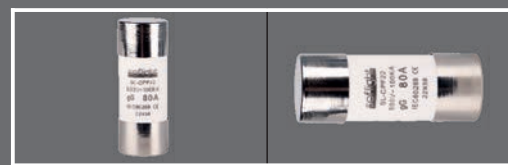

Código	Fusível	Int.(A)	Emb.	P.U.€
SL-CP22X58-10A-AM	22x58	10A	10un.	1,20€
SL-CP22X58-16A-AM	22x58	16A	10un.	1,20€
SL-CP22X58-20A-AM	22x58	20A	10un.	1,20€
SL-CP22X58-25A-AM	22x58	25A	10un.	1,20€
SL-CP22X58-32A-AM	22x58	32A	10un.	1,20€
SL-CP22X58-40A-AM	22x58	40A	10un.	1,20€
SL-CP22X58-50A-AM	22x58	50A	10un.	1,20€
SL-CP22X58-63A-AM	22x58	63A	10un.	1,20€
SL-CP22X58-80A-AM	22x58	80A	10un.	1,20€
SL-CP22X58-100A-AM	22x58	100A	10un.	1,20€
SL-CP22X58-125A-AM	22x58	125A	10un.	1,20€

### Bases Porta-Fusíveis F-N Cilíndricos

(IEC60269)



Código	Descrição	Nº Pol.	Tipo Fusível	Emb.	P.U.€
SL-CP07501	Base Porta- Fusível 1P+N	10x38	12/192	5,80€	

### Bases Porta-Fusíveis Cilíndricos

(IEC60269)



Código	Descrição	Nº Pol.	Tipo Fusível	Emb.	P.U.€
SL-CP07101	Base Porta- Fusível	1P	10x38	12/192	2,25€
SL-CP07102	Base Porta- Fusível	2P	10x38	6/96	5,15€
SL-CP07103	Base Porta- Fusível	3P	10x38	6/64	7,40€



Código	Descrição	Nº Pol.	Tipo Fusível	Emb.	P.U.€
SL-CP07201	Base Porta- Fusível	1P	14x51	12/192	6,70€
SL-CP07202	Base Porta- Fusível	2P	14x51	6/96	14,40€
SL-CP07203	Base Porta- Fusível	3P	14x51	4/64	20,00€



Código	Descrição	Nº Pol.	Tipo Fusível	Emb.	P.U.€
SL-CP07301	Base Porta- Fusível	1P	22x58	12/192	11,50€
SL-CP07302	Base Porta- Fusível	2P	22x58	6/96	23,50€
SL-CP07303	Base Porta- Fusível	3P	22x58	4/64	28,60€



# Disjuntores Caixa Moldada

**soflight**®

Electric

## Disjuntor em Caixa Moldada Eletromecânico

(IEC 60947-2)



Novos  
Podutos

Código	Pol.	Int.(A)	P.Corte	P.U.€
SL-CP063125	3P	125A	35KA	65,00€
SL-CP063160	3P	160A	50KA	190,00€
SL-CP063200	3P	200A	50KA	240,00€
SL-CP063250	3P	250A	50KA	270,00€
SL-CP063300	3P	300A	50KA	340,00€
SL-CP063350	3P	350A	50KA	510,00€
SL-CP063400	3P	400A	50KA	540,00€
SL-CP063500	3P	500A	70KA	735,00€
SL-CP063630	3P	630A	70KA	905,00€
SL-CP063800	3P	800A	70KA	1270,00€
SL-CP0631250	3P	1250A	125KA	2350,00€
SL-CP0631600	3P	1600A	150KA	3200,00€

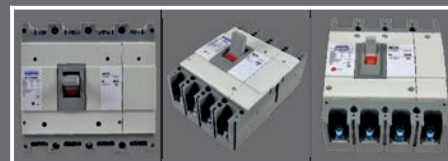

Novos  
Podutos

Código	Pol.	Int.(A)	P.Corte	P.U.€
SL-CP064125	4P	125A	35KA	81,00€
SL-CP064160	4P	160A	50KA	245,00€
SL-CP064200	4P	200A	50KA	270,00€
SL-CP064250	4P	250A	50KA	310,00€
SL-CP064300	4P	300A	50KA	405,00€
SL-CP064350	4P	350A	50KA	640,00€
SL-CP064400	4P	400A	70KA	765,00€
SL-CP064500	4P	500A	70KA	1182,00€
SL-CP064630	4P	630A	70KA	1225,00€
SL-CP064800	4P	800A	70KA	1630,00€
SL-CP0641250	4P	1250A	100KA	2650,00€
SL-CP0641600	4P	1600A	150KA	3850,00€



Novos  
Podutos

Código	Pol.	Int.(A)	P.Corte	P.U.€
SL-CP0632000	3P	2000A	80KA	7120,00€
SL-CP0632500	3P	2500A	100KA	9300,00€



Novos  
Podutos

Código	Pol.	Int.(A)	P.Corte	P.U.€
SL-CP0642000	4P	2000A	80KA	11925,00€
SL-CP0642500	4P	2500A	100KA	16300,00€

## Disjuntor em Caixa Moldada Eletromecânico, Ajustável

(IEC 60947-2)



Novos  
Podutos

Código	Pol.	Int.(A)	P.Corte	P.U.€
SL-CP063125AD	3P	125A	35KA	98,00€
SL-CP063160AD	3P	160A	50KA	245,00€
SL-CP063200AD	3P	200A	50KA	295,00€
SL-CP063225AD	3P	200A	50KA	305,00€
SL-CP063250AD	3P	250A	50KA	325,00€
SL-CP063300AD	3P	300A	50KA	395,00€
SL-CP063400AD	3P	400A	50KA	610,00€
SL-CP063630AD	3P	630A	70KA	995,00€
SL-CP063700AD	3P	700A	70KA	1050,00€
SL-CP063800AD	3P	800A	125KA	1410,00€

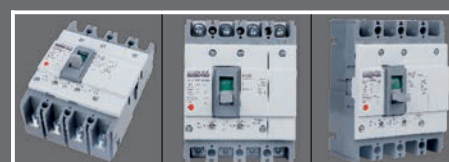

Novos  
Podutos

Código	Pol.	Int.(A)	P.Corte	P.U.€
SL-CP064125AD	4P	125A	35KA	118,00€
SL-CP064160AD	4P	160A	50KA	282,00€
SL-CP064200AD	4P	200A	50KA	305,00€
SL-CP064225AD	4P	200A	50KA	330,00€
SL-CP064250AD	4P	250A	50KA	360,00€
SL-CP064300AD	4P	300A	50KA	470,00€
SL-CP064400AD	4P	400A	70KA	815,00€
SL-CP064630AD	4P	630A	70KA	1325,00€
SL-CP064700AD	4P	700A	70KA	1395,00€
SL-CP064800AD	4P	800A	100KA	1735,00€

### Acessórios para Disjuntor em Caixa Moldada

#### Bobine de Emissão de Corrente



Código	Descrição	P.U.€
SL-CP06-125AUX-MX	Bobine de Disparo p/125A	46,00€
SL-CP06-160AUX-MX	Bobine de Disparo p/160A	46,00€
SL-CP06-315AUX-MX	Bobine de Disparo p/315A	46,00€
SL-CP06-630AUX-MX	Bobine de Disparo p/630A	95,00€
SL-CP06-800AUX-MX	Bobine de Disparo p/800A	95,00€

#### Bobine de Mínima Tensão



Código	Descrição	P.U.€
SL-CP06-125AUX-MN	Bob.Disp.Min.Tensão p/125A	74,00€
SL-CP06-160AUX-MN	Bob.Disp.Min.Tensão p/160A	74,00€
SL-CP06-315AUX-MN	Bob.Disp.Min.Tensão p/315A	96,00€
SL-CP06-630AUX-MN	Bob.Disp.Min.Tensão p/630A	107,00€
SL-CP06-800AUX-MN	Bob.Disp.Min.Tensão p/800A	107,00€

#### Contacto Auxiliar de Alarme



Código	Descrição	P.U.€
SL-CP06-125AUX-AL	Cont. Aux. Alarme p/125A	30,00€
SL-CP06-160AUX-AL	Cont. Aux. Alarme p/160A	30,00€
SL-CP06-315AUX-AL	Cont. Aux. Alarme p/315A	35,00€
SL-CP06-630AUX-AL	Cont. Aux. Alarme p/630A	36,50€
SL-CP06-800AUX-AL	Cont. Aux. Alarme p/800A	34,00€

#### Contacto Auxiliar



Código	Descrição	P.U.€
SL-CP06-125AUX-OF	Contacto Auxiliar p/125A	20,00€
SL-CP06-160AUX-OF	Contacto Auxiliar p/160A	25,50€
SL-CP06-315AUX-OF	Contacto Auxiliar p/315A	27,50€
SL-CP06-630AUX-OF	Contacto Auxiliar p/630A	30,10€
SL-CP06-800AUX-OF	Contacto Auxiliar p/800A	30,10€

### Interruptores Diferenciais Modulares Tipo AC ( IEC 61008 )

( Até 63A, Neutro á Direita 80 a 100A, Neutro á Esquerda )

Gama Doméstica, Terciária e Industrial



Tipo AC:  
 Detecção de Defeitos em  
 Correntes Alternadas

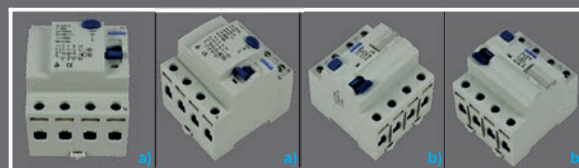

Código	Pol.	Int.(A)	Sens.	Emb.	P.U.€
SL-CP05216-30-AC	2P	16A	30mA	1/60	27,00€
SL-CP05225-10-AC	2P	25A	10mA	1/60	32,50€
SL-CP05225-30-AC	2P	25A	30mA	1/60	19,10€
SL-CP05240-30-AC	2P	40A	30mA	1/60	19,10€
SL-CP05263-30-AC	2P	63A	30mA	1/60	24,00€
SL-CP05280-30-AC	2P	80A	30mA	1/60	27,00€
SL-CP052100-30-AC	2P	100A	30mA	1/60	27,00€

Código	Pol.	Int.(A)	Sens.	Emb.	P.U.€
SL-CP05225-300-AC	2P	25A	300mA	1/60	18,70€
SL-CP05240-300-AC	2P	40A	300mA	1/60	18,70€
SL-CP05263-300-AC	2P	63A	300mA	1/60	23,25€
SL-CP05280-300-AC	2P	80A	300mA	1/60	27,00€
SL-CP052100-300-AC	2P	100A	300mA	1/60	27,00€

Código	Pol.	Int.(A)	Sens.	Emb.	P.U.€
SL-CP05425-30-AC	4P	25A	30mA	1/30	26,70€
SL-CP05440-30-AC	4P	40A	30mA	1/30	26,70€
SL-CP05463-30-AC	4P	63A	30mA	1/30	27,80€
SL-CP05480-30-AC	4P	80A	30mA	1/30	50,40€
SL-CP054100-30-AC	4P	100A	30mA	1/30	51,60€

Código	Pol.	Int.(A)	Sens.	Emb.	P.U.€
SL-CP05425-300-AC	4P	25A	300mA	1/30	26,70€
SL-CP05440-300-AC	4P	40A	300mA	1/30	26,70€
SL-CP05463-300-AC	4P	63A	300mA	1/30	28,40€
SL-CP05480-300-AC	4P	80A	300mA	1/30	50,40€
SL-CP054100-300-AC	4P	100A	300mA	1/30	57,95€

## Interruptores Diferenciais Modulares Tipo A - Super Imunizados ( IEC 61008 )

( Até 63A, Neutro à Direita 80 a 100A, Neutro à Esquerda )

Gama Doméstica, Terciária e Industrial



**Tipo A:**

Deteção de Defeitos em Correntes Alternadas + Deteção de Correntes com Componentes Contínua (DC) Pulsantes

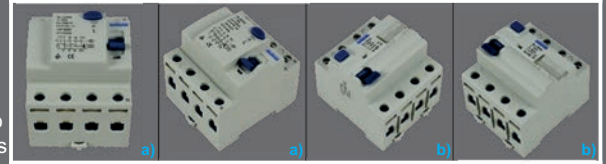

Código	Pol.	Int.(A)	Sens.	Emb.	P.U.€
SL-CP05225-30-A	2P	25A	30mA	1/60	37,80€
SL-CP05240-30-A	2P	40A	30mA	1/60	37,80€
SL-CP05263-30-A	2P	63A	30mA	1/60	39,00€
SL-CP05280-30-A	2P	80A	30mA	1/60	50,25€
SL-CP052100-30-A	2P	100A	30mA	1/60	50,25€

Código	Pol.	Int.(A)	Sens.	Emb.	P.U.€
SL-CP05225-300-A	2P	25A	300mA	1/60	37,80€
SL-CP05240-300-A	2P	40A	300mA	1/60	37,80€
SL-CP05263-300-A	2P	63A	300mA	1/60	39,00€
SL-CP05280-300-A	2P	80A	300mA	1/60	53,00€
SL-CP052100-300-A	2P	100A	300mA	1/60	53,00€

Código	Pol.	Int.(A)	Sens.	Emb.	P.U.€
SL-CP05425-30-A	4P	25A	30mA	1/30	51,00€
SL-CP05440-30-A	4P	40A	30mA	1/30	51,00€
SL-CP05463-30-A	4P	63A	30mA	1/30	54,00€
SL-CP05480-30-A	4P	80A	30mA	1/30	61,00€
SL-CP054100-30-A	4P	100A	30mA	1/30	65,50€

Código	Pol.	Int.(A)	Sens.	Emb.	P.U.€
SL-CP05425-300-A	4P	25A	300mA	1/30	51,00€
SL-CP05440-300-A	4P	40A	300mA	1/30	51,00€
SL-CP05463-300-A	4P	63A	300mA	1/30	54,00€
SL-CP05480-300-A	4P	80A	300mA	1/30	61,00€
SL-CP054100-300-A	4P	100A	300mA	1/30	65,50€

## Interruptores Diferenciais Modulares Tipo B ( IEC 61008 )

( Neutro à Esquerda )

Gama Doméstica, Terciária e Industrial



**Tipo B:**

Inclui Três Tecnologias de Deteção de Fuga:

- \* Detetor Electro-magnético (tipo A)
- \* Detetor Eletrónico p/Correntes de Defeito Contínuas
- \* Filtro de Altas Frequências



Código	Pol.	Int.(A)	Sens.	Emb.	P.U.€
SL-CP05225-30-B	2P	25A	30mA	1/60	280,00€
SL-CP05240-30-B	2P	40A	30mA	1/60	280,00€
SL-CP05263-30-B	2P	63A	30mA	1/60	290,00€
SL-CP052100-30-B	2P	100A	30mA	1/60	390,00€

Código	Pol.	Int.(A)	Sens.	Emb.	P.U.€
SL-CP05225-300-B	2P	25A	300mA	1/60	280,00€
SL-CP05240-300-B	2P	40A	300mA	1/60	280,00€
SL-CP05263-300-B	2P	63A	300mA	1/60	290,00€
SL-CP052100-300-B	2P	100A	300mA	1/60	390,00€

Código	Pol.	Int.(A)	Sens.	Emb.	P.U.€
SL-CP05425-30-B	4P	25A	30mA	1/30	340,00€
SL-CP05440-30-B	4P	40A	30mA	1/30	340,00€
SL-CP05463-30-B	4P	63A	30mA	1/30	350,00€
SL-CP054100-30-B	4P	100A	30mA	1/30	400,00€

Código	Pol.	Int.(A)	Sens.	Emb.	P.U.€
SL-CP05425-300-B	4P	25A	300mA	1/30	340,00€
SL-CP05440-300-B	4P	40A	300mA	1/30	340,00€
SL-CP05463-300-B	4P	63A	300mA	1/30	350,00€
SL-CP054100-300-B	4P	100A	300mA	1/30	400,00€

## Interruptores Diferenciais Modulares Tipo A + DC ( IEC 61008 )

( Neutro à Esquerda )

Gama Doméstica, Terciária e Industrial



**Tipo A + DC:**

Inclui Três Tecnologias de Deteção de Fuga:

- \* Detetor Electro-magnético (tipo A)
- \* Detetor Eletrónico p/Correntes de Defeito Contínuas
- \* Filtro de Altas Frequências



Código	Pol.	Int.(A)	Sens.	Emb.	P.U.€
SL-CP05240-30-A+DC	2P	40A	30mA	1/60	110,00€
SL-CP05263-30-A+DC	2P	63A	30mA	1/60	110,00€

Código	Pol.	Int.(A)	Sens.	Emb.	P.U.€
SL-CP05440-30-A+DC	4P	40A	30mA	1/30	130,00€
SL-CP05463-30-A+DC	4P	63A	30mA	1/30	130,00€

**Novos Podutos**

### Diferenciais Modulares Rearmáveis Tipo A - Super Imunizados ( IEC 61008 )

Gama Doméstica, Terciária e Industrial



- \* Até 6 Rearmes
- \* Aumento tempo rearme depois de cada ligação
- \* Possibilidade controlo Remoto
- \* Detecção de Defeitos em Correntes Alternadas + Detecção de Correntes com Componentes Contínua (DC) Pulsantes



Código	Pol.	Int.(A)	Sens.	Emb.	P.U.€
SL-CP05-RA240-30-A	2P	40A	30mA	1/60	153,00€
SL-CP05-RA263-30-A	2P	63A	30mA	1/60	154,00€

Código	Pol.	Int.(A)	Sens.	Emb.	P.U.€
SL-CP05-RA240-300-A	2P	40A	300mA	1/60	153,00€
SL-CP05-RA263-300-A	2P	63A	300mA	1/60	154,00€

Código	Pol.	Int.(A)	Sens.	Emb.	P.U.€
SL-CP05-RA440-30-A	4P	40A	30mA	1/30	175,00€
SL-CP05-RA463-30-A	4P	63A	30mA	1/30	180,00€
SL-CP05-RA480-30-A	4P	80A	30mA	1/30	215,00€

Código	Pol.	Int.(A)	Sens.	Emb.	P.U.€
SL-CP05-RA440-300-A	4P	40A	300mA	1/30	175,00€
SL-CP05-RA463-300-A	4P	63A	300mA	1/30	180,00€
SL-CP05-RA480-300-A	4P	80A	300mA	1/30	215,00€

### Disjuntores Diferenciais Modulares 6kA Curva C, Tipo AC

Gama Doméstica, Terciária e Industrial

( IEC 61008 )



Tipo AC:  
Detecção de Defeitos em Correntes Alternadas



Novos Podutos

Código	Pol.	Int.(A)	Sens.	Emb.	P.U.€
SL-CP02506DF30-AC	F+N	6A	30mA	1/60	25,00€
SL-CP02510DF30-AC	F+N	10A	30mA	1/60	25,00€
SL-CP02516DF30-AC	F+N	16A	30mA	1/60	25,00€
SL-CP02520DF30-AC	F+N	20A	30mA	1/60	25,00€
SL-CP02525DF30-AC	F+N	25A	30mA	1/60	25,00€
SL-CP02532DF30-AC	F+N	32A	30mA	1/60	25,00€
SL-CP02540DF30-AC	F+N	40A	30mA	1/60	27,00€
SL-CP02550DF30-AC	F+N	50A	30mA	1/60	27,00€
SL-CP02563DF30-AC	F+N	63A	30mA	1/60	27,00€
SL-CP02580DF30-AC	F+N	80A	30mA	1/60	30,00€
SL-CP025100DF30-AC	F+N	100A	30mA	1/60	35,00€
SL-CP025125DF30-AC	F+N	125A	30mA	1/60	35,00€

Código	Pol.	Int.(A)	Sens.	Emb.	P.U.€
SL-CP02506DF300-AC	F+N	6A	300mA	1/60	25,00€
SL-CP02510DF300-AC	F+N	10A	300mA	1/60	25,00€
SL-CP02516DF300-AC	F+N	16A	300mA	1/60	25,00€
SL-CP02520DF300-AC	F+N	20A	300mA	1/60	25,00€
SL-CP02525DF300-AC	F+N	25A	300mA	1/60	25,00€
SL-CP02532DF300-AC	F+N	32A	300mA	1/60	25,00€
SL-CP02540DF300-AC	F+N	40A	300mA	1/60	27,00€
SL-CP02550DF300-AC	F+N	50A	300mA	1/60	27,00€
SL-CP02563DF300-AC	F+N	63A	300mA	1/60	27,00€
SL-CP02580DF300-AC	F+N	80A	300mA	1/60	30,00€
SL-CP025100DF300-AC	F+N	100A	300mA	1/60	35,00€
SL-CP025125DF300-AC	F+N	125A	300mA	1/60	35,00€



Tipo AC:  
Detecção de Defeitos em Correntes Alternadas



Novos Podutos

Código	Pol.	Int.(A)	Sens.	Emb.	P.U.€
SL-CP02406DF30-AC	4P	6A	30mA	1/60	55,00€
SL-CP02410DF30-AC	4P	10A	30mA	1/60	55,00€
SL-CP02416DF30-AC	4P	16A	30mA	1/60	55,00€
SL-CP02420DF30-AC	4P	20A	30mA	1/60	55,00€
SL-CP02425DF30-AC	4P	25A	30mA	1/60	55,00€
SL-CP02432DF30-AC	4P	32A	30mA	1/60	55,00€
SL-CP02440DF30-AC	4P	40A	30mA	1/60	59,00€
SL-CP02450DF30-AC	4P	50A	30mA	1/60	59,00€
SL-CP02463DF30-AC	4P	63A	30mA	1/60	59,00€
SL-CP02480DF30-AC	4P	80A	30mA	1/60	69,00€
SL-CP024100DF30-AC	4P	100A	30mA	1/60	69,00€
SL-CP024125DF30-AC	4P	125A	30mA	1/60	69,00€

Código	Pol.	Int.(A)	Sens.	Emb.	P.U.€
SL-CP02406DF300-AC	4P	6A	300mA	1/60	55,00€
SL-CP02410DF300-AC	4P	10A	300mA	1/60	55,00€
SL-CP02416DF300-AC	4P	16A	300mA	1/60	55,00€
SL-CP02420DF300-AC	4P	20A	300mA	1/60	55,00€
SL-CP02425DF300-AC	4P	25A	300mA	1/60	55,00€
SL-CP02432DF300-AC	4P	32A	300mA	1/60	55,00€
SL-CP02440DF300-AC	4P	40A	300mA	1/60	59,00€
SL-CP02450DF300-AC	4P	50A	300mA	1/60	59,00€
SL-CP02463DF300-AC	4P	63A	300mA	1/60	59,00€
SL-CP02480DF300-AC	4P	80A	300mA	1/60	69,00€
SL-CP024100DF300-AC	4P	100A	300mA	1/60	69,00€
SL-CP024125DF300-AC	4P	125A	300mA	1/60	69,00€

## Bases Para Relés



Código	Descrição	Qt.Emb.	P.U.€
SL-CP-9022	Base para relé 8 Pinos	400/20	3,30€
SL-CP-9023	Base para Relé 11 Pinos	400/20	3,30€



Código	Descrição	Qt.Emb.	P.U.€
SL-CP-PF083A-E	Base para Relé 8 Pinos	400/20	1,95€
SL-CP-PF113A-E	Base para Relé 11 Pinos	400/20	1,95€

## Interruptores Modulares

(IEC 60947-3)

Gama Terciária e Industrial



Código	Pol.	Int.(A)	Emb.	P.U.€
SL-CP08132	1P	32A	12/180	3,75€
SL-CP08163	1P	63A	12/180	4,00€



Código	Pol.	Int.(A)	Emb.	P.U.€
SL-CP08232	2P	32A	6/90	8,60€
SL-CP08263	2P	63A	6/90	9,20€

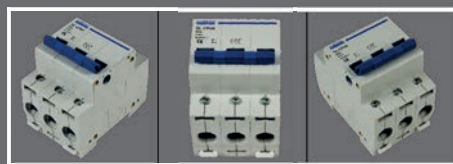

Código	Pol.	Int.(A)	Emb.	P.U.€
SL-CP08332	3P	32A	4/60	11,20€
SL-CP08363	3P	63A	4/60	12,00€
SL-CP08380	3P	80A	4/60	12,70€
SL-CP083100	3P	100A	4/60	13,60€



Código	Pol.	Int.(A)	Emb.	P.U.€
SL-CP08432	4P	32A	3/45	17,50€
SL-CP08463	4P	63A	3/45	17,90€
SL-CP08480	4P	80A	3/45	21,90€
SL-CP084100	4P	100A	3/45	23,70€
SL-CP084125	4P	125A	3/45	29,00€

## Interruptores Horários Analógicos

(73/23EEC - 89/336/EEC)

Gama Terciária e Industrial



- \* Programação Diário (24h):
- \* 1 Canal, Manobra Mini.30min.
- \* 230Vac / 16A
- \* 30 minutos x 48 Vezes
- \* Contactos: 1NO+1NC
- \* Funcion. Sincrono ou Quartzo
- \* Bateria Reserva: 150h
- \* Temp. trabalho: -40 + 55°C

Código	Modulos	Tipo	Int.(A)	Emb.	P.U.€
SL-CP12010	3	Analógico	16A	100	45,25€



- \* Func. Sincrono ou Quartzo
- \* Programação Diário (24h):
- \* 230Vac / 16A
- \* 15 minutos x 96 Vezes
- \* Contactos: 1NO
- \* 1 Canal, Manobra Mínimo 15min.
- \* Bateria Reserva: 70h
- \* Temp. Trabalho: -10 + 50°C

Código	Modulos	Tipo	Int.(A)	Emb.	P.U.€
SL-CP12020	1	Analógico	16A	200	36,55€

## Interruptor Horário Digital

(73/23EEC - 89/336/EEC)



- \* Funcionamento: Digital
- \* 230Vac / 12A
- \* 1 Canal, Manobra 0,5 minutos
- \* Contactos: 1NO+1NC
- \* Programação: Diário/Semanal
- \* Bateria Reserva: 60 dias
- \* Temp. Trabalho: 0 + 40°C

Código	Modulos	Tipo	Int.(A)	Emb.	P.U.€
SL-CP12025	2	Digital	16A	200	40,35€

## Automático Escada

(EN60947-5-1)

Gama Doméstica



- \* Ligação: 3 e 4 Fios
- \* 230Vac / 16A
- \* Autom./Manual (30s a 20m)
- \* Fluorescente: 750W
- \* Baixo Consumo: 750W
- \* Led: 750W
- \* Halogênio: 2000W
- \* Temp. Trabalho: 0 + 55°C

Código	Modulos	Int.(A)	Temp.	Emb.	P.U.€
SL-CP12030	1	16A	0,5-20m	12	19,95€

### Contactores Modulares (IEC61095 / EN61095)

Gama Terciária e Industrial



Código	Contactos	Tensão Bobine	Numero Modulos	Int.	P.U.€
SL-CP17225-1NO1NC-024	1NO1NC	24Vac	1	25A	18,75€
SL-CP17225-2NO-024	2NO	24Vac	1	25A	18,75€
SL-CP17225-1NO1NC-230	1NO1NC	240Vac	1	25A	18,75€
SL-CP17225-2NO-230	2NO	240Vac	1	25A	18,75€
SL-CP17263-2NO-024	2NO	24Vac	1	63A	22,75€
SL-CP17263-2NO-230	2NO	240Vac	1	63A	22,75€



Código	Contactos	Tensão Bobine	Numero Modulos	Int.	P.U.€
SL-CP17425-2NO2NC-024	2NO2NC	24Vac	2	25A	38,55€
SL-CP17425-4NO-024	4NO	24Vac	2	25A	38,55€
SL-CP17425-2NO2NC-230	2NO2NC	240Vac	2	25A	38,55€
SL-CP17425-4NO-230	4NO	240Vac	2	25A	38,55€



Código	Contactos	Tensão Bobine	Numero Modulos	Int.	P.U.€
SL-CP17463-2NO2NC-024	2NO2NC	24Vac	3	63A	42,50€
SL-CP17463-4NO-024	4NO	24Vac	3	63A	42,50€
SL-CP17463-2NO2NC-230	2NO2NC	240Vac	3	63A	42,50€
SL-CP17463-4NO-230	4NO	240Vac	3	63A	42,50€

### Campainha Modular (IEC 61558-1 / EN 61558-2-8)

Gama Terciária e Industrial



Código	Tensão Bobine	Inten.	Emb.	P.U.€
SL-CP1010-024	24Vac	6.5Va	12/180	4,90€
SL-CP1010-240	240Vac	6.5Va	12/180	4,90€

### Telerruptor Modular

Gama Terciária e Industrial

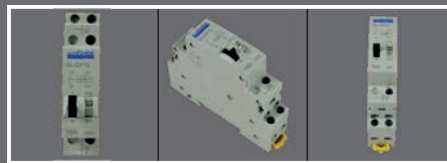

Código	Nº Pol.	Inten.	Tensão Bobine	Emb.	P.U.€
SL-CP12050-1NO-024	1P	16A	24V	12	16,80€
SL-CP12050-1NO-230	1P	16A	230V	12	16,80€

### Sinalizadores Modulares (IEC 60947-5-1)

Gama Terciária e Industrial



Código	Numero Modulos	Cor	Embalagem	P.U.€
SL-CP091RD	1	Vermelho	12/180	3,80€
SL-CP091YE	1	Amarelo	12/180	3,80€
SL-CP091GR	1	Verde	12/180	3,80€

### Sinalizadores Modulares (VM/VD/AM)



Código	Numero Modulos	Cor	Embalagem	P.U.€
SL-CP091RYG	1P	V/A/V	12/180	8,00€

### Tomada Modular Schuko c/Alvéolos

Gama Doméstica, Terciária e Industrial



Código	Numero Modulos	Nº Pol.	Intensidade	Embalagem	P.U.€
SL-CP13016	2,5	2P+T	16A	100	4,90€

### Transformador Modular (IEC 61558-1 / EN 61558-2-8)

Gama Terciária e Industrial



Código	Numero Modulos	Oções Voltgem	Inten.	Emb.	P.U.€
SL-CP11024	2	8/12/24V	8VA	100	13,35€

# Contadores

## Contadores AC ( IEC 947 )

soflight®

Gama Industrial

Electric

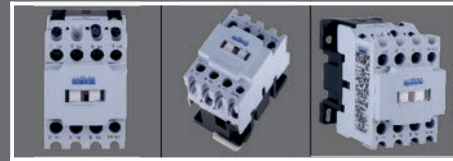

Código	Pólos	Pot.Motor 400V AC3 KW CV A	Ac1 A	Aux.	Tensão Bobine	P.U.€
SL-CP15012NO-024	3	5,5 7,5 12	20	NO	24V	10,70€
SL-CP15012NC-024	3	5,5 7,5 12	20	NC	24V	10,70€
SL-CP15012NO-048	3	5,5 7,5 12	20	NO	48V	10,70€
SL-CP15012NC-048	3	5,5 7,5 12	20	NC	48V	10,70€
SL-CP15012NO-110	3	5,5 7,5 12	20	NO	110V	10,70€
SL-CP15012NC-110	3	5,5 7,5 12	20	NC	110V	10,70€
SL-CP15012NO-220	3	5,5 7,5 12	20	NO	230V	10,70€
SL-CP15012NC-220	3	5,5 7,5 12	20	NC	230V	10,70€
SL-CP15012NO-380	3	5,5 7,5 12	20	NO	400V	10,70€
SL-CP15012NC-380	3	5,5 7,5 12	20	NC	400V	10,70€

Código	Pólos	Pot.Motor 400V AC3 KW CV A	Ac1 A	Aux.	Tensão Bobine	P.U.€
SL-CP15018NO-024	3	7,5 10 18	32	NO	24V	13,90€
SL-CP15018NC-024	3	7,5 10 18	32	NC	24V	13,90€
SL-CP15018NO-048	3	7,5 10 18	32	NO	48V	13,90€
SL-CP15018NC-048	3	7,5 10 18	32	NC	48V	13,90€
SL-CP15018NO-110	3	7,5 10 18	32	NO	110V	13,90€
SL-CP15018NC-110	3	7,5 10 18	32	NC	110V	13,90€
SL-CP15018NO-220	3	7,5 10 18	32	NO	230V	13,90€
SL-CP15018NC-220	3	7,5 10 18	32	NC	230V	13,90€
SL-CP15018NO-380	3	7,5 10 18	32	NO	400V	13,90€
SL-CP15018NC-380	3	7,5 10 18	32	NC	400V	13,90€

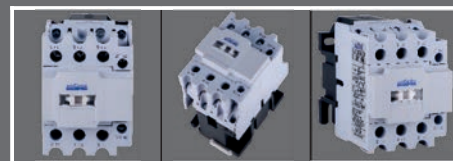

Código	Pólos	Pot.Motor 400V AC3 KW CV A	Ac1 A	Aux.	Tensão Bobine	P.U.€
SL-CP15025NO-024	3	11 15 25	40	NO	24V	18,95€
SL-CP15025NC-024	3	11 15 25	40	NC	24V	18,95€
SL-CP15025NO-048	3	11 15 25	40	NO	48V	18,95€
SL-CP15025NC-048	3	11 15 25	40	NC	48V	18,95€
SL-CP15025NO-110	3	11 15 25	40	NO	110V	18,95€
SL-CP15025NC-110	3	11 15 25	40	NC	110V	18,95€
SL-CP15025NO-220	3	11 15 25	40	NO	230V	18,95€
SL-CP15025NC-220	3	11 15 25	40	NC	230V	18,95€
SL-CP15025NO-380	3	11 15 25	40	NO	400V	18,95€
SL-CP15025NC-380	3	11 15 25	40	NC	400V	18,95€

Código	Pólos	Pot.Motor 400V AC3 KW CV A	Ac1 A	Aux.	Tensão Bobine	P.U.€
SL-CP15032NO-024	3	15 20 32	50	NO	24V	22,70€
SL-CP15032NC-024	3	15 20 32	50	NC	24V	22,70€
SL-CP15032NO-048	3	15 20 32	50	NO	48V	22,70€
SL-CP15032NC-048	3	15 20 32	50	NC	48V	22,70€
SL-CP15032NO-110	3	15 20 32	50	NO	110V	22,70€
SL-CP15032NC-110	3	15 20 32	50	NC	110V	22,70€
SL-CP15032NO-220	3	15 20 32	50	NO	230V	22,70€
SL-CP15032NC-220	3	15 20 32	50	NC	230V	22,70€
SL-CP15032NO-380	3	15 20 32	50	NO	400V	22,70€
SL-CP15032NC-380	3	15 20 32	50	NC	400V	22,70€

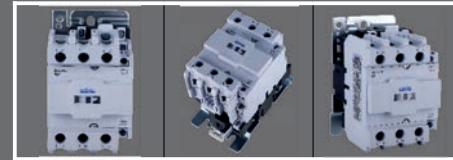
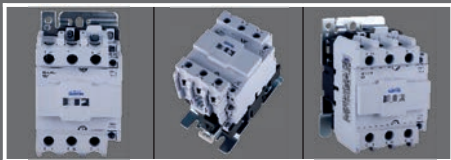

Código	Pólos	Pot.Motor 400V AC3 KW CV A	Ac1 A	Aux.	Tensão Bobine	P.U.€
SL-CP15040NO/NC-024	3	18,5 25 40	60	NO/NC	24V	54,20€
SL-CP15040NO/NC-048	3	18,5 25 40	60	NO/NC	48V	54,20€
SL-CP15040NO/NC-110	3	18,5 25 40	60	NO/NC	110V	54,20€
SL-CP15040NO/NC-220	3	18,5 25 40	60	NO/NC	230V	54,20€
SL-CP15040NO/NC-380	3	18,5 25 40	60	NO/NC	400V	54,20€

Código	Pólos	Pot.Motor 400V AC3 KW CV A	Ac1 A	Aux.	Tensão Bobine	P.U.€
SL-CP15050NO/NC-024	3	22 30 50	80	NO/NC	24V	58,60€
SL-CP15050NO/NC-048	3	22 30 50	80	NO/NC	48V	58,60€
SL-CP15050NO/NC-110	3	22 30 50	80	NO/NC	110V	58,60€
SL-CP15050NO/NC-220	3	22 30 50	80	NO/NC	230V	58,60€
SL-CP15050NO/NC-380	3	22 30 50	80	NO/NC	400V	58,60€

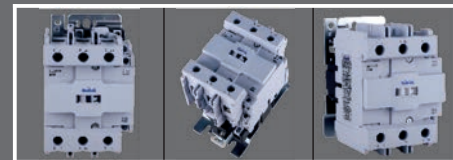

Código	Pólos	Pot.Motor 400V AC3 KW CV A	Ac1 A	Aux.	Tensão Bobine	P.U.€
SL-CP15065NO/NC-024	3	30 40 65	80	NO/NC	24V	62,35€
SL-CP15065NO/NC-048	3	30 40 65	80	NO/NC	48V	62,35€
SL-CP15065NO/NC-110	3	30 40 65	80	NO/NC	110V	62,35€
SL-CP15065NO/NC-220	3	30 40 65	80	NO/NC	230V	62,35€
SL-CP15065NO/NC-380	3	30 40 65	80	NO/NC	400V	62,35€

Código	Pólos	Pot.Motor 400V AC3 KW CV A	Ac1 A	Aux.	Tensão Bobine	P.U.€
SL-CP15080NO/NC-024	3	37 50 80	125	NO/NC	24V	81,90€
SL-CP15080NO/NC-048	3	37 50 80	125	NO/NC	48V	81,90€
SL-CP15080NO/NC-110	3	37 50 80	125	NO/NC	110V	81,90€
SL-CP15080NO/NC-220	3	37 50 80	125	NO/NC	230V	81,90€
SL-CP15080NO/NC-380	3	37 50 80	125	NO/NC	400V	81,90€



Código	Pólos	Pot.Motor 400V AC3 KW CV A	Ac1 A	Aux.	Tensão Bobine	P.U.€
SL-CP15095NO/NC-024	3	45 80 95	125	NO/NC	24V	95,35€
SL-CP15095NO/NC-048	3	45 80 95	125	NO/NC	48V	95,35€
SL-CP15095NO/NC-110	3	45 80 95	125	NO/NC	110V	95,35€
SL-CP15095NO/NC-220	3	45 80 95	125	NO/NC	230V	95,35€
SL-CP15095NO/NC-380	3	45 80 95	125	NO/NC	400V	95,35€

## Contacto Lateral Auxiliar p/Contactor

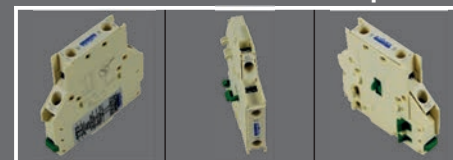

Código	Descrição	Contacto	Embal.	P.U.€
SL-CP15AUX-A8/11	Contacto Auxiliar 1NO+1NC	1/100	9,20€	

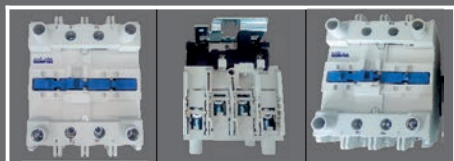

Código	Pólos	Pot. Motor 400V AC3			Ac1 A	Tensão Bobine	P.U.€
		KW	CV	A			
SL-CP15012-4P-024	4	5,5	7,5	12	20	24V	20,00€
SL-CP15012-4P-230	4	5,5	7,5	12	20	230V	20,00€
SL-CP15012-4P-400	4	5,5	7,5	12	20	400V	20,00€

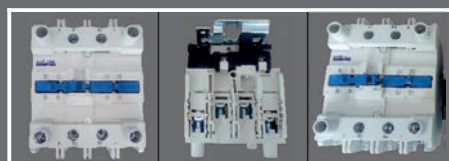

Código	Pólos	Pot. Motor 400V AC3			Ac1 A	Tensão Bobine	P.U.€
		KW	CV	A			
SL-CP15018-4P-024	4	7,5	10	18	32	24V	23,00€
SL-CP15018-4P-230	4	7,5	10	18	32	230V	23,00€
SL-CP15018-4P-400	4	7,5	10	18	32	400V	23,00€

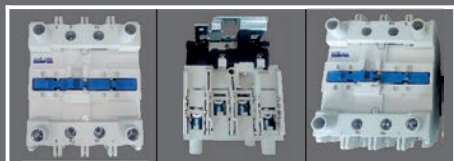

Código	Pólos	Pot. Motor 400V AC3			Ac1 A	Tensão Bobine	P.U.€
		KW	CV	A			
SL-CP15032-4P-024	4	15	20	32	50	24V	36,00€
SL-CP15032-4P-230	4	15	20	32	50	230V	36,00€
SL-CP15032-4P-400	4	15	20	32	50	400V	36,00€

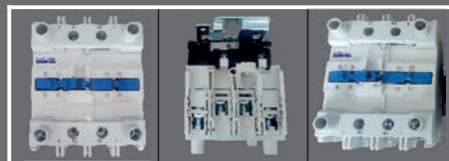

Código	Pólos	Pot. Motor 400V AC3			Ac1 A	Tensão Bobine	P.U.€
		KW	CV	A			
SL-CP15050-4P-024	4	22	30	50	80	24V	80,00€
SL-CP15050-4P-230	4	22	30	50	80	230V	80,00€
SL-CP15050-4P-400	4	22	30	50	80	400V	80,00€



Código	Pólos	Pot. Motor 400V AC3			Ac1 A	Tensão Bobine	P.U.€
		KW	CV	A			
SL-CP15095-4P-024	4	45	80	95	125	24V	130,00€
SL-CP15095-4P-230	4	45	80	95	125	230V	130,00€
SL-CP15095-4P-400	4	45	80	95	125	400V	130,00€



Código	Pólos	Pot. Motor 400V AC3			Ac1 A	Tensão Bobine	P.U.€
		KW	CV	A			
SL-CP150150-4P-024	4	75	100	150	220	24V	340,00€
SL-CP150150-4P-230	4	75	100	150	220	230V	340,00€
SL-CP150150-4P-400	4	75	100	150	220	400V	340,00€



Código	Pólos	Pot. Motor 400V AC3			Ac1 A	Tensão Bobine	P.U.€
		KW	CV	A			
SL-CP150225-4P-024	4	110	150	225	275	24V	450,00€
SL-CP150225-4P-230	4	110	150	225	275	230V	450,00€
SL-CP150225-4P-400	4	110	150	225	275	400V	450,00€



Código	Pólos	Pot. Motor 400V AC3			Ac1 A	Tensão Bobine	P.U.€
		KW	CV	A			
SL-CP150400-4P-024	4	200	270	400	450	24V	950,00€
SL-CP150400-4P-230	4	200	270	400	450	230V	950,00€
SL-CP150400-4P-400	4	200	270	400	450	400V	950,00€

## Contatores DC ( IEC 947 )

Gama Industrial



Código	Pólos	Pot. Motor 400V AC3			Ac1 A	Aux.	Tensão Bobine	P.U.€
		KW	CV	A				
SL-CP15018NO-024DC	3	5,5	7,5	12	20	NO	24Vdc	48,00€
SL-CP15018NC-024DC	3	5,5	7,5	12	20	NC	24Vdc	48,00€



Código	Pólos	Pot. Motor 400V AC3			Ac1 A	Aux.	Tensão Bobine	P.U.€
		KW	CV	A				
SL-CP15032NO-024DC	3	5,5	7,5	12	20	NO	24Vdc	91,00€
SL-CP15032NC-024DC	3	5,5	7,5	12	20	NC	24Vdc	91,00€



Código	Pólos	Pot. Motor 400V AC3			Ac1 A	Aux.	Tensão Bobine	P.U.€
		KW	CV	A				
SL-CP15050-024DC	3	5,5	7,5	12	20	NO+NC	24Vdc	170,00€



## Relés Térmicos p/ Contatores AC ( IEC 947 )



Código	Escala de Regulação	Para Contact. SL-CP15...	Emb.	P.U.€
SL-CP16D1303	0,25-0,40A	9 a 32A	1/100	10,25€
SL-CP16D1304	0,40-0,63A	9 a 32A	1/100	10,25€
SL-CP16D1305	0,63-1A	9 a 32A	1/100	10,25€
SL-CP16D1306	1-1,6A	9 a 32A	1/100	10,25€
SL-CP16D1307	1,5-2,5A	9 a 32A	1/100	10,25€
SL-CP16D1308	2,5-4A	9 a 32A	1/100	10,25€
SL-CP16D1310	4-6A	9 a 32A	1/100	10,25€
SL-CP16D1312	5,5-8A	9 a 32A	1/100	10,25€
SL-CP16D1314	07-10A	9 a 32A	1/100	10,25€
SL-CP16D1316	9-13A	9 a 32A	1/100	10,25€
SL-CP16D1321	12-18A	9 a 32A	1/100	10,25€
SL-CP16D1322	17-25A	9 a 32A	1/100	10,25€
SL-CP16D2353	23-32A	40 a 95A	1/100	26,70€
SL-CP16D2355	28-36A	40 a 95A	1/100	26,70€
SL-CP16D3355	30-40A	40 a 95A	1/100	26,70€

## Contactos Auxiliares p/ Contatores SL-CP15..., Montagem Frontal



Código	Descrição	Contacto	Emb.	P.U.€
SL-CP15AUX-A02	Contacto Auxiliar	2NC	1/100	4,15€
SL-CP15AUX-A11	Contacto Auxiliar	1NO+1NC	1/100	4,15€
SL-CP15AUX-A20	Contacto Auxiliar	2NO	1/100	4,15€

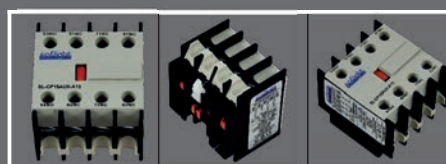

Código	Descrição	Contacto	Emb.	P.U.€
SL-CP15AUX-A04	Contacto Auxiliar	4NC	1/100	6,75€
SL-CP15AUX-A13	Contacto Auxiliar	1NO+3NC	1/100	6,75€
SL-CP15AUX-A22	Contacto Auxiliar	2NO+2NC	1/100	6,75€
SL-CP15AUX-A31	Contacto Auxiliar	3NO+1NC	1/100	6,75€
SL-CP15AUX-A40	Contacto Auxiliar	4NO	1/100	6,75€

## Relés Térmicos p/ Contatores AC ( IEC 947 )



Novos Podutos

Código	Escala de Regulação	Para Contact. SL-CP15...	P.U.€
SL-CP16-F53-30/50	30-50A	115-185A	255,00€
SL-CP16-F53-48/80	48-80A	115-185A	255,00€
SL-CP16-R53-60/100	60-100A	115-185A	255,00€
SL-CP16-F53-90/150	90-150A	115-185A	265,00€
SL-CP16-F53-132/22	132-220A	225-265A	355,00€
SL-CP16-F73-200/33	200-330A	225-500A	360,00€
SL-CP16-F73-300/50	300-500A	225-500A	365,00€

## Temporizadores pneumáticos para Contatores SL-CP15... ( IEC 947 )



\* Atraso à Operação  
\* Montagem Frontal  
\* 1NO + 1 NC

Código	Escala	Embalagem	P.U.€
SL-CP15TEMP-T0	0,1 a 3 Segundos	1/100	24,00€
SL-CP15TEMP-T2	0,1 a 30 Segundos	1/100	24,00€
SL-CP15TEMP-T4	10 a 180 Segundos	1/100	24,00€



\* Atraso à Desoperação  
\* Montagem Frontal  
\* 1NO + 1 NC

Código	Escala	Embalagem	P.U.€
SL-CP15TEMP-R0	0,1 a 3 Segundos	1/100	24,00€
SL-CP15TEMP-R2	0,1 a 30 Segundos	1/100	24,00€
SL-CP15TEMP-R4	10 a 180 Segundos	1/100	24,00€

### Inversor Manual



Código	Polos	Amperes	Emb.	P.U.€
SL-CP704160	4P	160A	1	320,00€
SL-CP704250	4P	250A	1	455,00€
SL-CP704400	4P	400A	1	669,00€
SL-CP704630	4P	630A	1	925,00€
SL-CP704800	4P	800A	1	1495,00€
SL-CP7041250	4P	1250A	1	2170,00€
SL-CP7041600	4P	1600A	1	2740,00€

### Inversor Motorizado



Código	Polos	Amperes	Emb.	P.U.€
SL-CP714160	4P	160A	1	1250,00€
SL-CP714400	4P	400A	1	1410,00€
SL-CP714630	4P	630A	1	1600,00€
SL-CP7141000	4P	1000A	1	2495,00€
SL-CP7141250	4P	1250A	1	2845,00€
SL-CP7141600	4P	1600A	1	4950,00€

### Controlador para inversor



Código	Descrição	Emb.	P.U.€
SL-CP71-ATS4-I	Controlador para Inversor		250,00€

### Inversor Manual / Automático 1-0-2 / 125A



Código	Polos	Amperes	Emb.	P.U.€
SL-CP7241125	4P	125A	1	250,00€

### Inversor Modular Manual 2P



Código	Polos	Amperes	Emb.	P.U.€
SL-CP25240	2P	40A	6	13,00€
SL-CP252125	2P	125A	6	40,00€

### Inversor Modular Manual 4P



Código	Polos	Amperes	Emb.	P.U.€
SL-CP25440	4P	40A	3	26,00€
SL-CP254125	4P	125A	3	78,00€

### Contador Energia Monofásico



Código	Polos	Amp.	Comunicação	P.U.€
CTE-1PH100A-MB	F/N	100A	Modbus/RS485	57,50€

### Contador Energia Trifásico



Código	Polos	Amp.	Comunicação	P.U.€
CTE-3PH80A-MB	3P	80A	Modbus/RS485	120,00€

## Bobines para Contatores AC, SL-CP15...

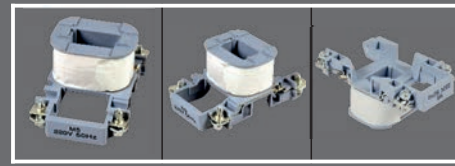

Código	Para Contactor	Tensão Bobine	Emb.	P.U.€
SL-CP15B18024	9-18A	24V	1/20	4,25€
SL-CP15B18048	9-18A	48V	1/20	4,25€
SL-CP15B18110	9-18A	110V	1/20	4,25€
SL-CP15B18220	9-18A	220V	1/20	4,25€
SL-CP15B18380	9-18A	380V	1/20	4,25€

Código	Para Contactor	Tensão Bobine	Emb.	P.U.€
SL-CP15B32024	25-32A	24V	1/20	5,20€
SL-CP15B32048	25-32A	48V	1/20	5,20€
SL-CP15B32110	25-32A	110V	1/20	5,20€
SL-CP15B32220	25-32A	220V	1/20	5,20€
SL-CP15B32380	25-32A	380V	1/20	5,20€

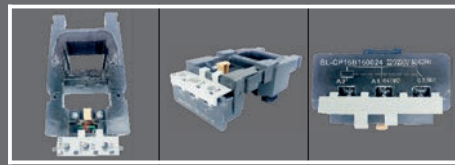
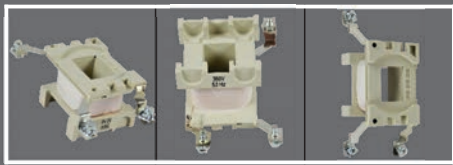

Novos Podutos

Código	Para Contactor	Tensão Bobine	Emb.	P.U.€
SL-CP15B95024	40-95A	24V	1/20	9,00€
SL-CP15B95048	40-95A	48V	1/20	9,00€
SL-CP15B95110	40-95A	110V	1/20	9,00€
SL-CP15B95220	40-95A	220V	1/20	9,00€
SL-CP15B95380	40-95A	380V	1/20	9,00€

Código	Para Contactor	Tensão Bobine	Emb.	P.U.€
SL-CP15B150024	150-185A	24V	1/20	47,50€
SL-CP15B150048	150-185A	48V	1/20	47,50€
SL-CP15B150110	150-185A	110V	1/20	47,50€
SL-CP15B150230	150-185A	230V	1/20	47,50€
SL-CP15B150400	150-185A	400V	1/20	47,50€



Novos Podutos



Novos Podutos

Código	Para Contactor	Tensão Bobine	Emb.	P.U.€
SL-CP15B225024	225-265A	24V	1/20	67,50€
SL-CP15B225048	225-265A	48V	1/20	67,50€
SL-CP15B225110	225-265A	110V	1/20	67,50€
SL-CP15B225230	225-265A	230V	1/20	67,50€
SL-CP15B225400	225-265A	400V	1/20	67,50€

Código	Para Contactor	Tensão Bobine	Emb.	P.U.€
SL-CP15B400024	225-500A	24V	1/20	167,50€
SL-CP15B400048	225-500A	48V	1/20	167,50€
SL-CP15B400110	225-500A	110V	1/20	167,50€
SL-CP15B400230	225-500A	230V	1/20	167,50€
SL-CP15B400400	225-500A	400V	1/20	167,50€

## Encravamento Mecânico p/Cont.

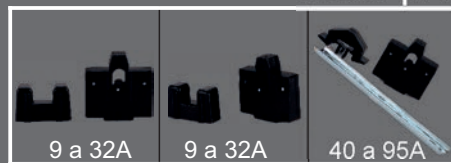

Novos Podutos

Código	Para Contactor	Embalagem	P.U.€
SL-CP15ENC-9-32A	9 a 32A	120	3,80€
SL-CP15ENC-40-95A	40 a 95A	40	5,90€
SL-CP15ENC-115-150	115 a 150A	20	35,00€
SL-CP15ENC-185-225	185 a 225A	20	47,00€
SL-CP15ENC-265-330	265 a 330A	20	55,00€

### Mini Contatores

( IEC 60947-4-1 )

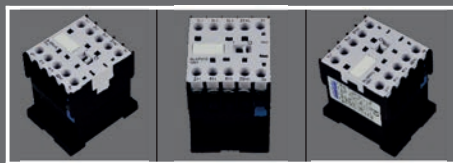

Código	Pólos	Pot. Motor KW	400V AC3 CV	A	Ac1 A	Aux.	Tensão Bobine	P.U.€
SL-CP21012NO-024	3	5,5	7,5	12	20	NO	24V	15,50€
SL-CP21012NC-024	3	5,5	7,5	12	20	NC	24V	15,50€
SL-CP21012NO-220	3	5,5	7,5	12	20	NO	230V	15,50€
SL-CP21012NC-220	3	5,5	7,5	12	20	NC	230V	15,50€
SL-CP21012NO-380	3	5,5	7,5	12	20	NO	400V	15,50€
SL-CP21012NC-380	3	5,5	7,5	12	20	NC	400V	15,50€

### Relés Térmicos Mini Contatores

( IEC 60947-4-1 )



Código	Escala de Regulação	Para Contactor	Emb.	P.U.€
SL-CP211307	1,2-1,8A	SL-CP21...	1/10	24,00€
SL-CP211308	1,8-2,6A	SL-CP21...	1/10	24,00€
SL-CP211309	2,6-3,7A	SL-CP21...	1/10	24,00€
SL-CP211310	3,7-5,5A	SL-CP21...	1/10	24,00€
SL-CP211311	5,5-8,0A	SL-CP21...	1/10	24,00€
SL-CP211312	8,0-11,5A	SL-CP21...	1/10	24,00€

### Discontactor sem Relé Térmico

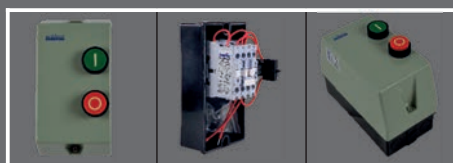

Código	Descrição	Tensão Bobine	Emb.	P.U.€
SL-CP22018-230	Contactador 18A	230V	1/100	30,00€
SL-CP22018-380	Contactador 18A	400V	1/100	30,00€
SL-CP22032-230	Contactador 32A	230V	1/100	56,00€
SL-CP22032-380	Contactador 32A	400V	1/100	56,00€

### Limitador Sobretensão (IEC61643.1)

Gama Terciária e Industrial



\* Tipo: 2  
\* Número Polos: 2  
\* Voltagem Max.: 275Vac  
\* Corrente:  
Mínima Descarga: 20kA  
Máxima Descarga: 40kA  
\* Nivel Protecção Tensão 1,8kV  
\* Temper. Trabalho: -40 a 80°C

Código	Número Módulos	Descrição	Emb.	P.U.€
SL-CP14240KA	2P	20-40KA 275V T1+T2.	136	47,00€

### Disjuntor Motor Magnetotérmico 3P

( IEC947-2,947-4-1 )

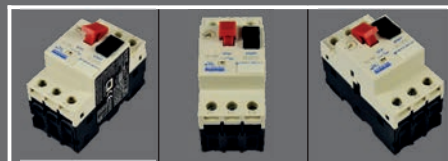

Código	Descrição	Escala de Regulação	Emb.	P.U.€
SL-CP19V2M01	Disjuntor Motor	0,63-1A	1/50	34,00€
SL-CP19V2M02	Disjuntor Motor	1-1,6A	1/50	34,00€
SL-CP19V2M03	Disjuntor Motor	1,6-2,5A	1/50	34,00€
SL-CP19V2M04	Disjuntor Motor	2,5-4A	1/50	34,00€
SL-CP19V2M05	Disjuntor Motor	4-6,3A	1/50	34,00€
SL-CP19V2M06	Disjuntor Motor	6-10A	1/50	34,00€
SL-CP19V2M07	Disjuntor Motor	9-14A	1/50	34,00€
SL-CP19V2M08	Disjuntor Motor	13-18A	1/50	34,00€
SL-CP19V2M09	Disjuntor Motor	17-23A	1/50	34,00€
SL-CP19V2M10	Disjuntor Motor	20-25A	1/50	34,00€
SL-CP19V2M11	Disjuntor Motor	24-32A	1/50	34,00€

### Caixa para Disjuntor Motor



Código	Descrição	Embal.	P.U.€
SL-CP19V2MC02	Caixa Vazia p/ Disjuntor Motor	1/100	14,00€

### Contacto Auxiliar Lateral p/ Disj.Motor



Código	Descrição	Contacto	Embal.	P.U.€
SL-CP19V2AN11	Contacto Auxiliar	1NO+1NC	1/50	9,10€
SL-CP19V2AN20	Contacto Auxiliar	2NO	1/50	9,10€

### Contacto Auxiliar Frontal p/ Disj.Motor



Código	Descrição	Contacto	Embal.	P.U.€
SL-CP19EA11	Contacto Auxiliar	1NO+1NC	1/50	8,60€

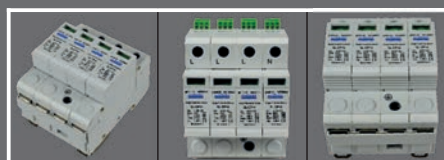

\* Tipo: 2  
\* Número Polos: 4  
\* Voltagem Max.: 415Vac  
\* Corrente:  
Mínima Descarga: 20kA  
Máxima Descarga: 40kA  
\* Nivel Protecção Tensão 1,8kV  
\* Temper. Trabalho: -40 a 80°C

Código	Número Módulos	Descrição	Emb.	P.U.€
SL-CP14440KA	4P	20-40KA 415V T1+T2.	114	101,00€



Código	Dimensões (mm)	NºMod.	Emb.	P.U.€
SL-CP51004	112(L)x199(A)x95(P)	4	1/30	8,70€



Código	Dimensões (mm)	NºMod.	Emb.	P.U.€
SL-CP51008	183(L)x199(A)x95(P)	8	1/30	13,10€



Código	Dimensões (mm)	NºMod.	Emb.	P.U.€
SL-CP51012	255(L)x199(A)x95(P)	12	1/30	18,90€



Código	Dimensões (mm)	NºMod.	Emb.	P.U.€
SL-CP51018	362(L)x220(A)x99(P)	18	1/10	25,50€



Código	Dimensões (mm)	NºMod.	Emb.	P.U.€
SL-CP51024	255(L)x327(A)x119(P)	24	1/10	28,60€

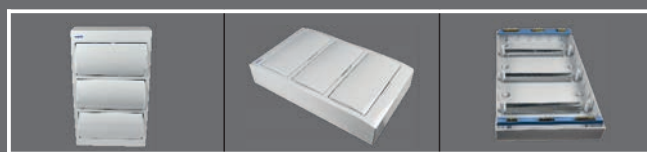

Código	Dimensões (mm)	NºMod.	Emb.	P.U.€
SL-CP51036	255(L)x500(A)x119(P)	36	1/5	46,60€

## Quadros Distribuição Embutir ( IEC 60439 )



Código	Dimensões (mm)	NºMod.	Emb.	P.U.€
SL-CP52004	136(L)x221(A)x34(P) Dimens.Caixa (mm) 123(L)x208(A)x56(P)	4	1/30	8,70€



Código	Dimensões (mm)	NºMod.	Emb.	P.U.€
SL-CP52008	207(L)x221(A)x34(P) Dimens.Caixa (mm) 195(L)x208(A)x56(P)	8	1/30	12,00€



Código	Dimensões (mm)	NºMod.	Emb.	P.U.€
SL-CP52012	278(L)x221(A)x34(P) Dimens.Caixa (mm) 266(L)x208(A)x56(P)	12	1/30	17,40€



Código	Dimensões (mm)	NºMod.	Emb.	P.U.€
SL-CP52018	397(L)x251(A)x34(P) Dimens.Caixa (mm) 384(L)x238(A)x66(P)	18	1/10	25,30€



Código	Dimensões (mm)	NºMod.	Emb.	P.U.€
SL-CP52024	300(L)x345(A)x34(P) Dimens.Caixa (mm) 288(L)x333(A)x66(P)	24	1/10	41,50€



Código	Dimensões (mm)	NºMod.	Emb.	P.U.€
SL-CP52036	300(L)x500(A)x34(P) Dimens.Caixa (mm) 288(L)x488(A)x66(P)	36	1/5	47,20€

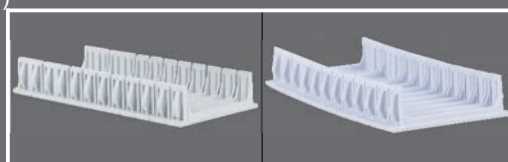

Novos  
Podutos

Código	Descrição	P.U.€
SL-CP50-6M-BR	Máscara / Obturador 6M, Branca	0,60€
SL-CP50-6M-CZ	Máscara / Obturador 6M, Cinza	0,60€

### Quadros Salientes IP 65 (EN 50022)



Código	Dimensões (mm)	NºMod.	Emb.	P.U.€
SL-CP53004	L140xA256xP100	4	1/20	17,30€

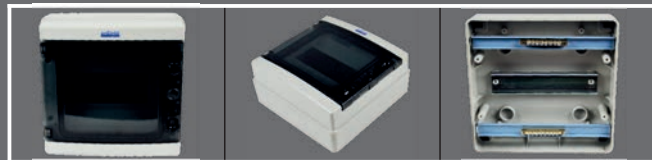

Código	Dimensões	NºMod.	Emb.	P.U.€
SL-CP53008	L212xA256xP100	8	1/20	26,60€



Código	Dimensões	NºMod.	Emb.	P.U.€
SL-CP53012	L295xA256xP140	12	1/10	38,20€

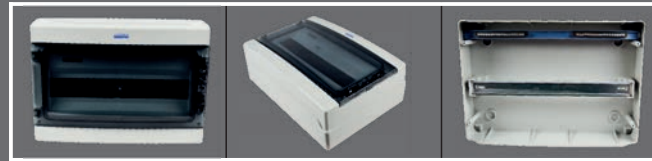

Código	Dimensões	NºMod.	Emb.	P.U.€
SL-CP53018	L410xA283xP140	18	1/5	58,70€

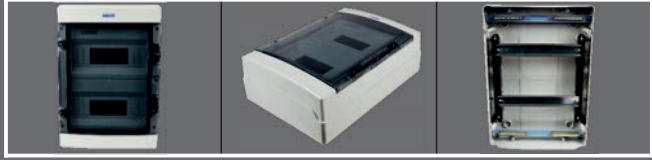

Código	Dimensões	NºMod.	Emb.	P.U.€
SL-CP53024	L296xA283xP140	24	1/5	76,50€

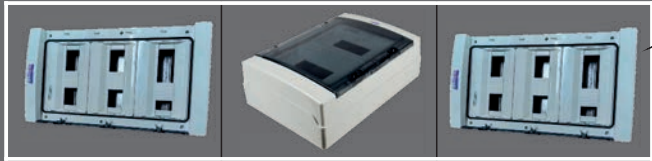

Código	Dimensões	NºMod.	Emb.	P.U.€
SL-CP53036	L319xA572xP150	36	1/4	126,50€

### Quadros salientes



Código	Dimensões	NºMod.	Emb.	P.U.€
SL-CP50002	L50xA130xP60	2	240	2,95€



Código	Dimensões	NºMod.	Emb.	P.U.€
SL-CP50004	L85xA130xP60	4	100	4,00€

### Pentes Ligação Ponteira c/1 Metro

Código	Descrição	Tipo	Int.(A)	NºPolos	Emb.	P.U.€
SL-CP58001	Pente 1P Ponteira	63A	1	100	7,40€	



SL-CP58002	Pente 2P Ponteira	63A	2	50	20,50€
------------	-------------------	-----	---	----	--------



SL-CP58DPN	Pente FN Ponteira	63A	1P+N	50	26,80€
------------	-------------------	-----	------	----	--------



SL-CP58003	Pente 3P Ponteira	63A	3	50	21,25€
------------	-------------------	-----	---	----	--------

SL-CP58004	Pente 4P Ponteira	63A	4	50	42,10€
------------	-------------------	-----	---	----	--------

### Pentes Ligação Forquilha c/1 Metro

Código	Descrição	Tipo	Int.(A)	NºPoi.	Emb.	P.U.€
SL-CP59001	Pente 1P Forquilha	63A	1	100	8,80€	



SL-CP59002	Pente 2P Forquilha	63A	2	100	21,90€
------------	--------------------	-----	---	-----	--------



SL-CP59003	Pente 3P Forquilha	63A	3	25	22,70€
------------	--------------------	-----	---	----	--------



SL-CP59004-63A	Pente 4 P Forquilha	63A	4	25	39,80€
----------------	---------------------	-----	---	----	--------



Novos Podutos

SL-CP59004	Pente 4 P Forquilha	80A	4	25	45,00€
------------	---------------------	-----	---	----	--------

### Topos para Pentes de Ligação



Código	Descrição	Embal.	P.U.€
SL-CP58T01	Topo p/SL-CP58001/SL-CP59001	200/20	0,26€ <sup>a)</sup>
SL-CP58T02	Topo p/SL-CP58002/SL-CP59002	200/20	0,29€ <sup>b)</sup>
SL-CP58T03	Topo p/SL-CP58003/SL-CP59003	200/20	0,37€
SL-CP58T04	Topo p/SL-CP58004/SL-CP59004	200/20	0,47€

Código	Dimensões	Emb.	P.U.€
SL-CP58050	Conector de Polos p/Cabos	20/1000	1,90€



## Botão Pressão Plástico

( EN60947-5-1 )

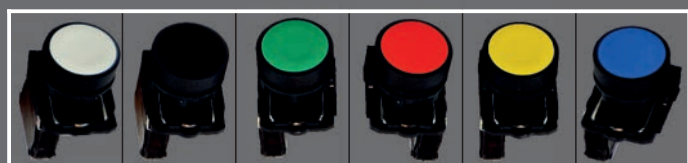

Código	Cor	Contacto	Embalagem	P.U.€
SL-CPB01-AA11	Branco	1NO	200/20	3,35€
SL-CPB01-AA21	Preto	1NO	200/20	3,35€
SL-CPB01-AA31	Verde	1NO	200/20	3,35€
SL-CPB01-AA42	Vermelho	1NC	200/20	3,35€
SL-CPB01-AA51	Amarelo	1NO	200/20	3,35€
SL-CPB01-AA61	Azul	1NO	200/20	3,35€

## Botão Pressão Plástico Saliente

( EN60947-5-1 )



Código	Cor	Contacto	Embalagem	P.U.€
SL-CPB01-EL21	Preto	1NO	200/20	3,65€
SL-CPB01-EL31	Verde	1NO	200/20	3,65€
SL-CPB01-EL51	Amarelo	1NO	200/20	3,65€
SL-CPB01-EL42	Vermelho	1NC	200/20	3,65€

## Botão Pres.Plástico Luminoso 24Vac Botão Pres.Plástico Luminoso 230Vac

( EN60947-5-1 )

( EN60947-5-1 )



Código	Cor	Contacto	Embalagem	P.U.€
SL-CPB01-AW3161-024	Branco	1NO	200/20	6,00€
SL-CPB01-AW3361-024	Verde	1NO	200/20	6,00€
SL-CPB01-AW3462-024	Vermelho	1NC	200/20	6,00€
SL-CPB01-AW3561-024	Amarelo	1NO	200/20	6,00€
SL-CPB01-AW3661-024	Azul	1NO	200/20	6,00€



Código	Cor	Contacto	Embalagem	P.U.€
SL-CPB01-AW3161-230	Branco	1NO	200/20	6,00€
SL-CPB01-AW3361-230	Verde	1NO	200/20	6,00€
SL-CPB01-AW3462-230	Vermelho	1NC	200/20	6,00€
SL-CPB01-AW3561-230	Amarelo	1NO	200/20	6,00€
SL-CPB01-AW3661-230	Azul	1NO	200/20	6,00€

## Seletor Plástico Luminoso 24Vac

( EN60947-5-1 )



Código	Descrição	Tensão	Cor	Cont.	P.U.€
SL-CPB01-BK2365-024	2 Pos.Fixas	24V	BR	1NO	9,50€
SL-CPB01-BK2465-024	2 Pos.Fixas	24V	AM	1NO	9,50€
SL-CPB01-BK2565-024	2 Pos.Fixas	24V	AZ	1NO	9,50€
SL-CPB01-BK2665-024	2 Pos.Fixas	24V	VD	1NO	9,50€
SL-CPB01-BK2765-024	2 Pos.Fixas	24V	VM	1NC	9,50€

## Seletor Plástico Luminoso 230Vac

( EN60947-5-1 )

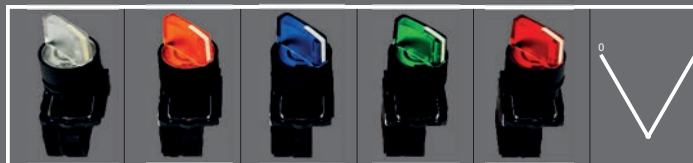

Código	Descrição	Tensão	Cor	Cont.	P.U.€
SL-CPB01-BK2365-230	2 Pos.Fixas	230V	BR	1NO	9,50€
SL-CPB01-BK2465-230	2 Pos.Fixas	230V	AM	1NO	9,50€
SL-CPB01-BK2565-230	2 Pos.Fixas	230V	AZ	1NO	9,50€
SL-CPB01-BK2665-230	2 Pos.Fixas	230V	VD	1NO	9,50€
SL-CPB01-BK2765-230	2 Pos.Fixas	230V	VM	1NC	9,50€

## Seletor Plástico Manípulo Curto

( EN60947-5-1 )

## Seletor Plástico Manípulo Curto

( EN60947-5-1 )

Novos Podutos

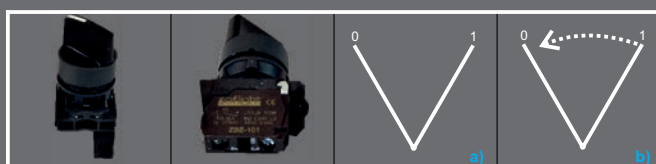

Código	Descrição	Contacto	Embal.	P.U.€
SL-CPB01-AD21	2 Posições Fixas	1NO	200/20	4,50€ <sup>a)</sup>
SL-CPB01-AD41	2 Pos. c/Retorno	1NO	200/20	4,85€ <sup>b)</sup>

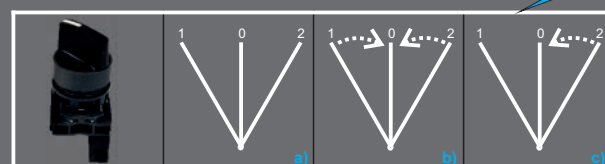

Código	Descrição	Contacto	P.U.€
SL-CPB01-AD33	3 Posições Fixas	2 NO	4,85€ <sup>a)</sup>
SL-CPB01-AD53	3 Pos. c/Retorno	2 NO	5,50€ <sup>b)</sup>
SL-CPB01-ED73	1 Pos. Fixa + 1 Pos.c/Retorno	2 NO	6,00€ <sup>c)</sup>

Electric

### Seletor Plástico com Chave ( EN60947-5-1 )



Código	Descrição	Contacto	Embalagem	P.U.€
SL-CPB01-AG21	2 Posições Fixas	1NO	200/20	7,00€

### Seletor Plástico com Chave

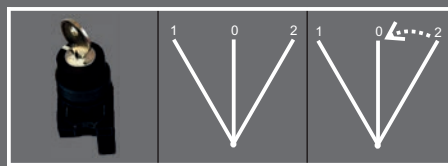

Código	Descrição	Contacto	P.U.€
SL-CPB01-AG33	3 Posições Fixas	2NO	9,70€ a)
SL-CPB01-EG73	1 Pos. Fixa + 1 Pos.c/Retorno	2NO	9,70€ b)

Novos Produtos

### Botão Cogum.Plást.s/Encravamento ( EN60947-5-1 )



Código	Cor	Contacto	Embalagem	P.U.€
SL-CPB01-AC21	Preto	1NO	200/20	4,00€
SL-CPB01-AC31	Verde	1NO	200/20	4,00€
SL-CPB01-AC42	Vermelho	1NC	200/20	4,00€

### Botão Cog.Plástico c/Encrav. Rotativo ( EN60947-5-1 )



Código	Cor	Contacto	Embalagem	P.U.€
SL-CPB01-AS542	Vermelho	1NC	200/20	4,90€

### Botão Cog.Plás.c/Encravam.C/Chave ( EN60947-5-1 )



Código	Descrição	Contacto	Embalagem	P.U.€
SL-CPB01-ZBE101	Contacto Auxiliar	1NO	200/20	1,50€
SL-CPB01-ZBE102	Contacto Auxiliar	1NC	200/20	1,50€



Código	Cor	Contacto	Embalagem	P.U.€
SL-CPB01-AS142	Vermelho	1NC	200/20	6,70€

### Botão Pressão Plástico Duplo ( EN60947-5-1 )



Código	Cor	Contacto	Embalagem	P.U.€
SL-CPB01-AL8325	VM/VD	1NO+1NC	200/20	7,70€

### Botão Plástico Duplo Luminoso ( EN60947-5-1 )



Código	Cor	Contacto	Embalagem	P.U.€
SL-CPB01BW8465-024	VD/VM	1NO+1NC	200/20	9,50€
SL-CPB01BW8466-230	VD/VM	1NO+1NC	200/20	9,50€

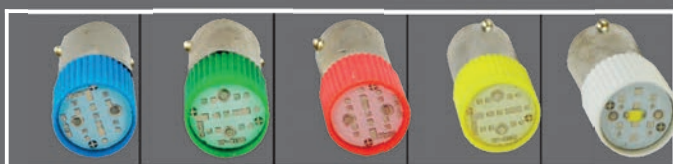

Código	Descrição	Casq.	Tensão	Cor	P.U.€
SL-CPB01-BA9S024V-BL	Lâmp. Led BA9S	24V	AZ	3,30€	
SL-CPB01-BA9S024V-GR	Lâmp. Led BA9S	24V	VD	3,30€	
SL-CPB01-BA9S024V-RD	Lâmp. Led BA9S	24V	VM	3,30€	
SL-CPB01-BA9S024V-WH	Lâmp. Led BA9S	24V	BR	3,30€	
SL-CPB01-BA9S024V-YE	Lâmp. Led BA9S	24V	AM	3,30€	
Código	Descrição	Casq.	Tensão	Cor	P.U.€
SL-CPB01-BA9S048V-BL	Lâmp. Led BA9S	48V	AZ	3,30€	
SL-CPB01-BA9S048V-GR	Lâmp. Led BA9S	48V	VD	3,30€	
SL-CPB01-BA9S048V-RD	Lâmp. Led BA9S	48V	VM	3,30€	
SL-CPB01-BA9S048V-WH	Lâmp. Led BA9S	48V	BR	3,30€	
SL-CPB01-BA9S048V-YE	Lâmp. Led BA9S	48V	AM	3,30€	



Código	Descrição	Casq.	Tensão	Cor	P.U.€
SL-CPB01-BA9S110V-BL	Lâmp. Led BA9S	110V	AZ	3,30€	
SL-CPB01-BA9S110V-GR	Lâmp. Led BA9S	110V	VD	3,30€	
SL-CPB01-BA9S110V-RD	Lâmp. Led BA9S	110V	VM	3,30€	
SL-CPB01-BA9S110V-WH	Lâmp. Led BA9S	110V	BR	3,30€	
SL-CPB01-BA9S110V-YE	Lâmp. Led BA9S	110V	AM	3,30€	
Código	Descrição	Casq.	Tensão	Cor	P.U.€
SL-CPB01-BA9S230V-BL	Lâmp. Led BA9S	230V	AZ	3,30€	
SL-CPB01-BA9S230V-GR	Lâmp. Led BA9S	230V	VD	3,30€	
SL-CPB01-BA9S230V-RD	Lâmp. Led BA9S	230V	VM	3,30€	
SL-CPB01-BA9S230V-WH	Lâmp. Led BA9S	230V	BR	3,30€	
SL-CPB01-BA9S230V-YE	Lâmp. Led BA9S	230V	AM	3,30€	



# Sinalizadores Compactos

soflight®

( EN60947-5-1 )

Electric

## Sinalizador Compacto Ø 22mm Led



Código	Cor	Tensão	Emb.	P.U.€
SL-CPB01-22DS-GR-024	Verde	24V	500/20	2,50€
SL-CPB01-22DS-RD-024	Vermelho	24V	500/20	2,50€
SL-CPB01-22DS-YE-024	Amarelo	24V	500/20	2,50€
SL-CPB01-22DS-BL-024	Azul	24V	500/20	2,50€
SL-CPB01-22DS-WH-024	Branco	24V	500/20	2,50€



Código	Cor	Tensão	Emb.	P.U.€
SL-CPB01-22DS-GR-230	Verde	230V	500/20	2,50€
SL-CPB01-22DS-RD-230	Vermelho	230V	500/20	2,50€
SL-CPB01-22DS-YE-230	Amarelo	230V	500/20	2,50€
SL-CPB01-22DS-BL-230	Azul	230V	500/20	2,50€
SL-CPB01-22DS-WH-230	Branco	230V	500/20	2,50€

## Besouro Ø 22mm Led Sem Flash



Código	Descrição	Tensão	Embal.	P.U.€
SL-CPB01-22FM-024	Besouro s/Flash	24V	500/20	5,50€
SL-CPB01-22FM-230	Besouro s/Flash	230V	500/20	5,50€

## Besouro Ø 22mm Led com Flash



Código	Descrição	Tensão	Embal.	P.U.€
SL-CPB01-22SM-024	Besouro c/Flash	24V	500/20	6,10€
SL-CPB01-22SM-230	Besouro c/Flash	230V	500/20	6,10€

## Amperímetro Ø 22mm



Novos  
Produtos

Código	Descrição	Embal.	P.U.€
SL-CPB01-22AM-VD	Amperímetro	500/20	8,65€
SL-CPB01-22AM-VM	Amperímetro	500/20	8,65€
SL-CPB01-22AM-AM	Amperímetro	500/20	8,65€

## Voltímetro Ø 22mm



Novos  
Produtos

Código	Descrição	Embal.	P.U.€
SL-CPB01-22VM-VD	Voltímetro	500/20	3,95€
SL-CPB01-22VM-VM	Voltímetro	500/20	3,95€
SL-CPB01-22VM-AN	Voltímetro	500/20	3,95€

## Frequencímetro Ø 22mm



Novos  
Produtos

Código	Descrição	Embal.	P.U.€
SL-CPB01-22HZ-VD	Frequencímetro	500/20	3,95€
SL-CPB01-22HZ-VM	Frequencímetro	500/20	3,95€
SL-CPB01-22HZ-AM	Frequencímetro	500/20	3,95€

## Sinalizador Ø 22mm Duplo Led



Código	Cor	Tensão	Embal.	P.U.€
SL-CPB01-127-RG-024	Vermelho/Verde	24V	500/20	6,85€
SL-CPB01-127-RG-230	Vermelho/Verde	230V	500/20	6,85€

## Chave para Botões Ø 22mm



Código	Descrição	Embal.	P.U.€
SL-CPB01-CH02	Chave para Botão 22mm	500/20	0,70€

Código	Descrição	Embal.	P.U.€
SL-CPB01-CH01	Chave para Botão 22mm	500/20	2,25€

## Caixas em Plástico

### Caixa Plástica com 1 Botão



Código	Descrição	Contacto	Embal.	P.U.€
SL-CPB01-CXB101H29	Botão Start	1NO	100	8,70€



Código	Descrição	Contacto	Embal.	P.U.€
SL-CPB01-CXB361H29	Seletor 2 Pos.	1NO	100	12,00€

### Caixa Plástico c/Emerg. c/Encravam. ( EN60947-5-1 )



Código	Descrição	Contacto	Embal.	P.U.€
SL-CPB01-CXB111H29	Botão Stop	1NC	100	8,70€



Código	Descrição	Contacto	Embal.	P.U.€
SL-CPB01-CXBJ174	Botão Emerg.	1NC	100	8,70€

### Caixa Plástica c/Emerg. s/Encravamento



Código	Descrição	Contacto	Embal.	P.U.€
SL-CPB01-CXB116	Botão Emerg.	1NC	100	8,70€

### Caixa Plástica c/Emerg. c/Chave



Código	Descrição	Contacto	Embal.	P.U.€
SL-CPB01-CXBJ178	Emerg.com Chave	1C	100	8,70€

### Caixa Plástica com 2 Botões



Código	Descrição	Contacto	Embal.	P.U.€
SL-CPB01-CXB211H29	Start/Stop	1NO+1NC	100	11,50€

### Caixa Plástica c/2 Botões + Sinaliz.



Código	Descrição	Contacto	Embal.	P.U.€
SL-CPB01-CXB132H29	Start/Stop	1NO+1NC	100	11,50€

### Caixa Plástica Vazia para SL-CPB01



Código	Descrição	Nº Furos	Emb.	P.U.€
SL-CPB01-CXB-01	Caixa Vazia	1	100	3,90€
SL-CPB01-CXB-02	Caixa Vazia	2	100	5,15€
SL-CPB01-CXB-03	Caixa Vazia	3	100	7,10€
SL-CPB01-CXB-04	Caixa Vazia	4	100	10,10€

### Caixa Plástica Vazia para SL-CPB01

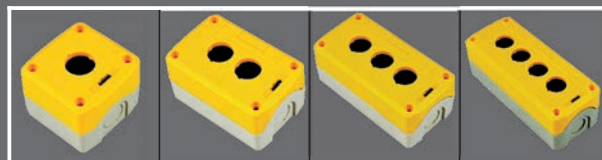

Código	Descrição	Nº Furos	Emb.	P.U.€
SL-CPB01-CXB-01Y	Caixa Vazia	1	100	3,90€
SL-CPB01-CXB-02Y	Caixa Vazia	2	100	5,15€
SL-CPB01-CXB-03Y	Caixa Vazia	3	100	7,00€
SL-CPB01-CXB-04Y	Caixa Vazia	4	100	10,10€



Código	Descrição	Contacto	Embal.	P.U.€
SL-CPB01-CXB142H29	Pos.c/Chave	1NO	100	12,00€

### Etiqueta para Botões Ø 22mm



Código	Descrição	Embal.	P.U.€
SL-CPB01-F10	Etiqueta para Botão 22mm	500/20	0,25€



Código	Descrição	Embal.	P.U.€
SL-CPB01-F11	Etiqueta para Botão 22mm	500/20	0,35€

# Botões Metálicos

soflight®

Electric

## Botão Pressão Metálico ( EN60947-5-1 )



Código	Cor	Contacto	Embal.	P.U.€
SL-CPB02-BA21	Preto	1NO	200/20	3,15€
SL-CPB02-BA31	Verde	1NO	200/20	3,15€
SL-CPB02-BA42	Vermelho	1NC	200/20	3,15€
SL-CPB02-BA51	Amarelo	1NO	200/20	3,15€
SL-CPB02-BA61	Azul	1NO	200/20	3,15€

## Sinalizadores Metálicos

( EN60947-5-1 )

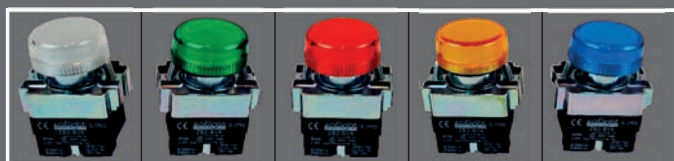

Código	Cor	Tensão	Embal.	P.U.€
SL-CPB02-BV61-024	Branco	24V	200/20	3,40€
SL-CPB02-BV63-024	Verde	24V	200/20	3,40€
SL-CPB02-BV64-024	Vermelho	24V	200/20	3,40€
SL-CPB02-BV65-024	Amarelo	24V	200/20	3,40€
SL-CPB02-BV66-024	Azul	24V	200/20	3,40€

Código	Cor	Tensão	Embal.	P.U.€
SL-CPB02-BV61-230	Branco	230V	200/20	3,40€
SL-CPB02-BV63-230	Verde	230V	200/20	3,40€
SL-CPB02-BV64-230	Vermelho	230V	200/20	3,40€
SL-CPB02-BV65-230	Amarelo	230V	200/20	3,40€
SL-CPB02-BV66-230	Azul	230V	200/20	3,40€

## Seletor Metálico Manípulo Curto

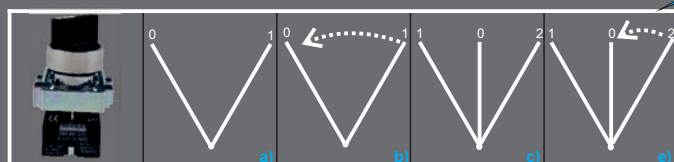

Código	Descrição	Contacto	P.U.€
SL-CPB02-BD21	2 Pos. Fixa	1NO	4,85€ <sup>a)</sup>
SL-CPB02-BD41	2 Pos. C/Ret.	1NO	4,85€ <sup>b)</sup>
SL-CPB02-BD33	3 Pos. Fixas	2NO	5,35€ <sup>c)</sup>
SL-CPB02-BD73	1 Pos. Fixa + 1 Pos. c/Retorno	2NO	8,00€ <sup>e)</sup>

## Seletor Metálico com Chave

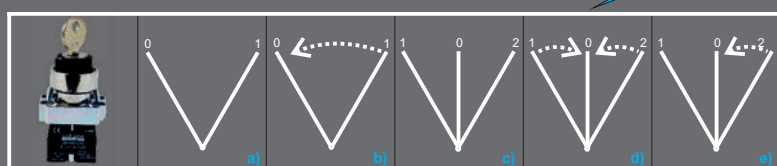

Código	Descrição	Contacto	P.U.€
SL-CPB02-BG21	2 Pos. Fixas	1NO	5,95€ <sup>a)</sup>
SL-CPB02-BG41	2 Pos. C/Retorno	1NO	6,10€ <sup>b)</sup>
SL-CPB02-BG33	3 Pos. Fixas	2NO	7,50€ <sup>c)</sup>
SL-CPB02-BG53	3 Pos. C/Retorno	2NO	7,85€ <sup>d)</sup>
SL-CPB02-BG73	1 Pos. Fixa + 1 Pos.c/Retorno	2NO	8,00€ <sup>d)</sup>

## Botão Pres.Met. Prot. Borr. ( EN60947-5-1 )

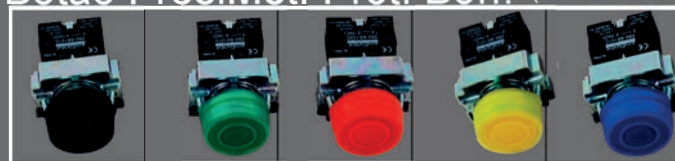

Código	Cor	Contacto	Embal.	P.U.€
SL-CPB02-BP21	Preto	1NO	200/20	3,40€
SL-CPB02-BP31	Verde	1NO	200/20	3,40€
SL-CPB02-BP42	Vermelho	1NC	200/20	3,40€
SL-CPB02-BP51	Amarelo	1NO	200/20	3,40€
SL-CPB02-BP61	Azul	1NO	200/20	3,40€

## Botão Cog.Met.s/Encravam.40mm

( EN60947-5-1 )



Código	Cor	Contacto	Embal.	P.U.€
SL-CPB02-BC21	Preto	1NO	200/20	3,75€
SL-CPB02-BC31	Verde	1NO	200/20	3,75€
SL-CPB02-BC42	Vermelho	1NC	200/20	3,75€

## Botão Cogum.Met.C/Encravam.40mm

( EN60947-5-1 )



Código	Cor	Contacto	Embal.	P.U.€
SL-CPB02-BS542	Vermelho	1NC	200/20	4,00€

## Botão Cog.Met.C/Encravam.30mm

( EN60947-5-1 )

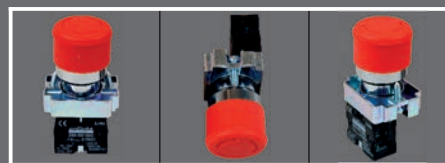

Código	Cor	Contacto	Embal.	P.U.€
SL-CPB02-BS442	Vermelho	1NC	200/20	4,00€

## Botão Cogum. Met. c/Chave 40mm

( EN60947-5-1 )

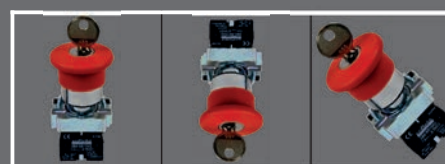

Código	Cor	Contacto	Embal.	P.U.€
SL-CPB02-BS142	Vermelho	1NC	200/20	8,95€

### Manípulo Metálico 22mm

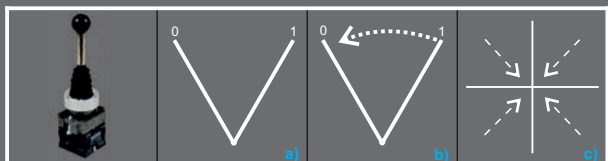

### Manípulo Metálico 30mm

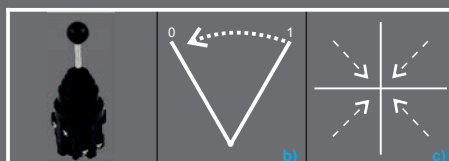

Código	Descrição	Contacto	Embalagem	P.U.€
SL-CPB02-PA12	2 Posições Fixas	2NO	200/10	10,30€ <sup>a)</sup>
SL-CPB02-PA22	2 Pos.c/retorno	2NO	200/10	12,00€ <sup>b)</sup>
SL-CPB02-PA24	4 Pos.c/retorno	4NO	200/10	13,90€ <sup>c)</sup>

Código	Descrição	Contacto	Embalagem	P.U.€
SL-CPB02-C201	2 Pos. c/Retorno	2NO	200/10	21,60€ <sup>a)</sup>
SL-CPB02-C402	4 Pos. c/Retorno	4NO	200/10	26,50€ <sup>b)</sup>

### Botão Pressão Duplo Metálico



Código	Cor	Contacto	Embalagem	P.U.€
SL-CPB02-BL8325	VM/VD	1NO+1NC	200/20	8,60€

### Contactos para Botões



Código	Descrição	Contacto	Embalagem	P.U.€
SL-CPB02-BE101	Contacto	NO	100	1,70€ <sup>a)</sup>
SL-CPB02-BE102	Contacto	NC	100	1,70€ <sup>b)</sup>
SL-CPB02-BZ101	Contacto+Base	NO	50	2,00€ <sup>c)</sup>
SL-CPB02-BZ102	Contacto+Base	NC	50	2,00€ <sup>d)</sup>

## Relés de Estado Sólido Monofásicos



- \* LED Indicador de Estado
- \* Tempo de Intervenção  $\leq$  10 ms
- \* Control de Intensidade  $\leq$  12 mA
- \* Dimensões: L58x44xP30mm



Código	Input	Output	Fases	Int.(A)	P.U.€
SL-CP241-310A	80-250Vac	90-480Vac	1	10A	18,80€
SL-CP241-325A	80-250Vac	90-480Vac	1	25A	23,90€
SL-CP241-340A	80-250Vac	90-480Vac	1	40A	25,90€
SL-CP241-360A	80-250Vac	90-480Vac	1	60A	38,00€
SL-CP241-380A	80-250Vac	90-480Vac	1	80A	51,55€

Código	Input	Output	Fases	Int.(A)	P.U.€
SL-CP241-310B	3-32Vdc	90-480Vac	1	10A	18,80€
SL-CP241-325B	3-32Vdc	90-480Vac	1	25A	23,90€
SL-CP241-340B	3-32Vdc	90-480Vac	1	40A	25,90€
SL-CP241-360B	3-32Vdc	90-480Vac	1	60A	38,00€
SL-CP241-380B	3-32Vdc	90-480Vac	1	80A	47,25€

## Relés de Estado Sólido Trifásicos



- \* LED Indicador de Estado
- \* Tempo de Intervenção  $\leq$  10 ms
- \* Control de Intensidade  $\leq$  12 mA
- \* Dimensões: L105x74x40mm



Código	Input	Output	Fases	Int.(A)	P.U.€
SL-CP243B320A	80-250Vac	90-480Vac	3	20A	75,20€
SL-CP243B340A	80-250Vac	90-480Vac	3	40A	95,00€

Código	Input	Output	Fases	Int.(A)	P.U.€
SL-CP243B320B	3-32Vdc	90-480Vac	3	20A	63,90€
SL-CP243B340B	3-32Vdc	90-480Vac	3	40A	75,70€

## Dissipadores p/Relé Estado Sólido



Código	Descrição	P.U.€
SL-CP24DIS-1X40A	Dissipador para Relé 1 Fase 10-40A	6,65€
SL-CP24DIS-1X80A	Dissipador para 1 Fase 60-80A	14,50€
SL-CP24DIS-3X40A	Dissipador para 3 Fases 10-40A	29,80€

## Interruptor de Manobra ( Acionamento Central) : Seccionadores ( EN60947-3 )

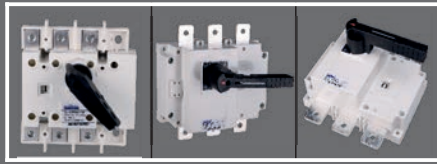

Novos Podutos



Novos Podutos

Código	Polos	AC-21 400V (A)	Potência AC3/400V/KW	Emb.	P.U.€
SL-CP683100	3P	100A	55kW	1/10	45,80€
SL-CP683160	3P	160A	80kW	1/10	68,80€
SL-CP683250	3P	250A	100kW	1/8	90,00€
SL-CP683400	3P	400A	220kW	1	165,00€
SL-CP683630	3P	630A	315kW	1	250,00€
SL-CP683800	3P	800A	450kW	1	490,00€
SL-CP6831000	3P	1000A	560kW	1	650,00€
SL-CP6831250	3P	1250A	560kW	1	670,00€
SL-CP6831600	3P	1600A	560kW	1	910,00€
SL-CP682000	3P	2000A	560kW	1	2100,00€
SL-CP6832500	3P	2500A	710kW	1	2450,00€
SL-CP6833150	3P	3150A	710kW	1	3330,00€

Código	Polos	AC-21 A	Potência AC3/400V/KW	Emb.	P.U.€
SL-CP684100	4P	100A	55kW	1/10	47,00€
SL-CP684160	4P	160A	80kW	1/10	80,80€
SL-CP684250	4P	250A	100kW	1/8	127,00€
SL-CP684400	4P	400A	220kW	1	190,00€
SL-CP684630	4P	630A	315kW	1	280,00€
SL-CP684800	4P	800A	450kW	1	595,00€
SL-CP6841000	4P	1000A	560kW	1	650,00€
SL-CP6841250	4P	1250A	560kW	1	705,00€
SL-CP681600	4P	1600A	560kW	1	1135,00€
SL-CP682000	4P	2000A	560kW	1	2225,00€
SL-CP6842500	4P	2500A	710kW	1	2670,00€
SL-CP6843150	4P	3150A	710kW	1	4050,00€

## Manípulos para Interruptores



Código	Descrição	Emb.	P.U.€
SL-CP68MAN-100	Manípulo para Int. 63-100A	1	17,90€
SL-CP68MAN-630	Manípulo para Int. 160-630A	1	33,60€
SL-CP68MAN-3150	Manípulo para Int. 800-3150A	1	52,90€

## Calha DIN

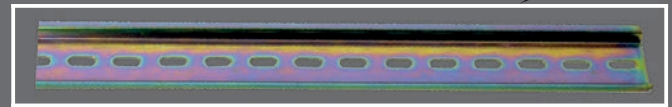

Novos Podutos

Código	Descrição	Embalagem	P.U.€
SL-CP60001	Calha DIN ( 1 Metro )	20/100	2,60€
SL-CP60002	Calha DIN ( 2 Metros )	20/100	5,20€
SL-CP60011	Calha DIN 15mm Alt.( 1 Metro )	20/100	5,50€
SL-CP60012	Calha DIN 15mm Alt.( 2 Metros )	20/100	11,00€

## Bloco Repartidor Unipolar 80 a 500A



Código	Ent.	Capacidade (mm2)	Emb.	P.U.€
SL-CP-BR-80A	1x16	4x6+2x16	1/200	7,15€ a)
SL-CP-BR-125A	1x35+1x16	6x16	1/100	14,90€ b)
SL-CP-BR-160A	1x70+1x16	6x16	1/100	15,40€ c)
SL-CP-BR-250A	1x120	2x35+5x16+4x10	1/50	38,40€ d)
SL-CP-BR-400A	1x185	2x35+5x16+4x10	1/50	41,80€ e)
SL-CP-BR-500A	1x185	2x35+5x16+4x10	1/50	44,00€ f)

## Repartidor de Escada

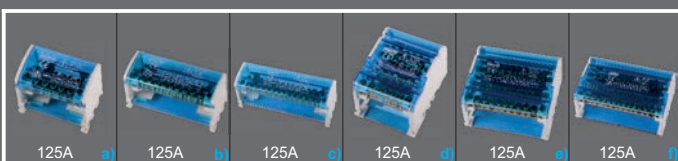

Código	Polos	Capacidade	Embalagem	P.U.€
SL-CP-RE-2X7	2X7	4X25+10X16	2/200	8,30€ a)
SL-CP-RE-2X11	2X11	4X35+4X25+14X16	1/120	11,30€ b)
SL-CP-RE-2X15	2X15	4X35+4X25+22X16	1/100	14,90€ c)
SL-CP-RE-4X7	4X7	8X35+20X16	1/100	15,70€ d)
SL-CP-RE-4X11	4X11	8X35+8X25+28X16	1/60	21,80€ e)
SL-CP-RE-4X15	4X15	8X35+8X25+44X16	1/50	28,50€ f)



Novos Podutos

Código	Descrição	P.U.€
SL-CP600TP-PT	Topo para Calha DIN Preto	0,57€
SL-CP600TP-TR	Topo para Calha DIN Preto	0,57€

## Ferramenta Corte Calha DIN



Novos Podutos

Código	Descrição	P.U.€
SL-CP-NS02	Ferramenta Corte Calha DIN Alumínio-1,5mm Chapa-1,0mm	410,00€

## Repartidor de Escada

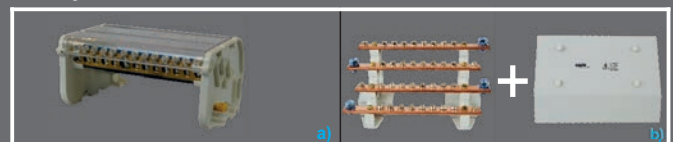

Código	Amperes	Embalagem	P.U.€
SL-CP-RE-4X13-160A	160A	2/200	58,00€ a)
SL-CP-RE-4X11-200A	200A	1/120	90,00€ b)
SL-CP-RE-4X11-250A	250A	1/100	130,00€ c)
SL-CP-RE-4X10-400A	400A	1/100	175,00€ d)

### Microswitch 125,250,380V - 15A

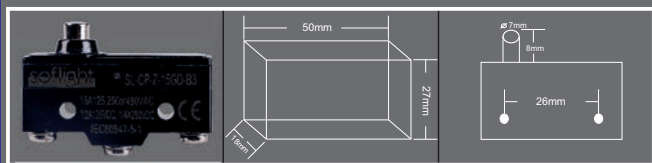

Código	Descrição	Embalagem	P.U.€
SL-CP-Z-15GD-B3	Microswitch	200/20	4,25€

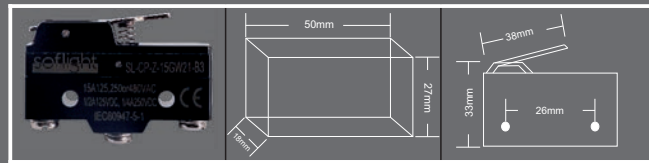

Código	Descrição	Embalagem	P.U.€
SL-CP-Z-15GW21-B3	Microswitch	200/20	5,15€

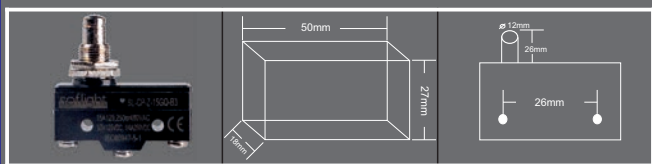

Código	Descrição	Embalagem	P.U.€
SL-CP-Z-15GQ-B3	Microswitch	200/20	5,40€

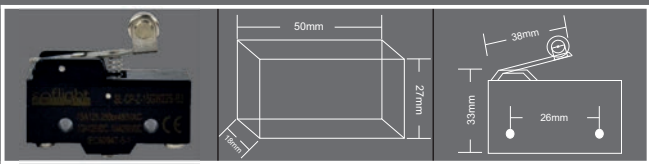

Código	Descrição	Embalagem	P.U.€
SL-CP-Z-15GW22S-B3	Microswitch	200/20	5,40€

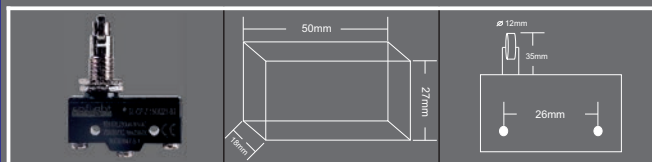

Código	Descrição	Embalagem	P.U.€
SL-CP-Z-15GQ21-B3	Microswitch	200/20	5,40€

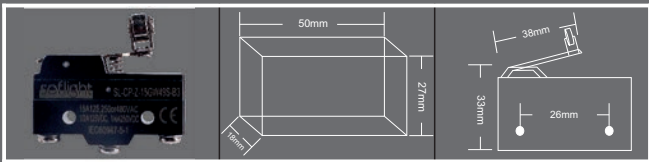

Código	Descrição	Embalagem	P.U.€
SL-CP-Z-15GW49S-B3	Microswitch	200/20	5,40€

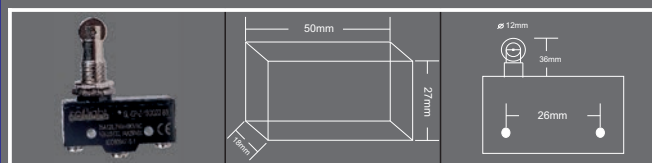

Código	Descrição	Embalagem	P.U.€
SL-CP-Z-15GQ22-B3	Microswitch	200/20	5,40€

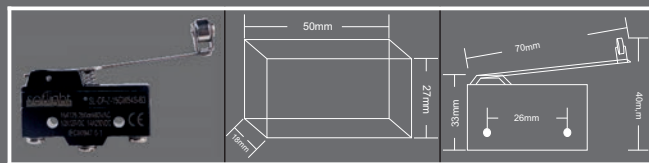

Código	Descrição	Embalagem	P.U.€
SL-CP-Z-15GW54S-B3	Microswitch	200/20	5,40€

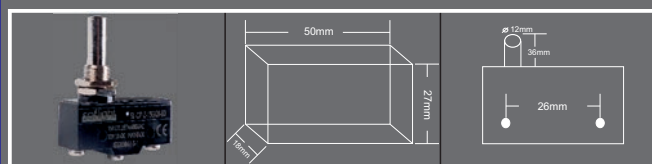

Código	Descrição	Embalagem	P.U.€
SL-CP-Z-15GQ8-B3	Microswitch	200/20	5,65€

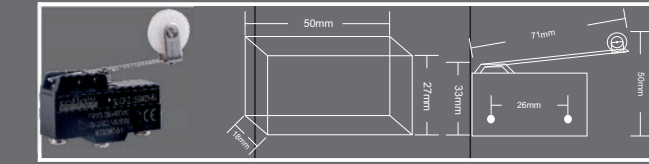

Código	Descrição	Embalagem	P.U.€
SL-CP-Z-15GW25-B3	Microswitch	200/20	5,80€

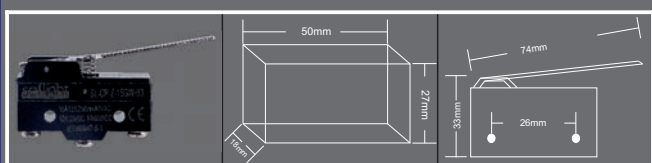

Código	Descrição	Embalagem	P.U.€
SL-CP-Z-15GW-B3	Microswitch	200/20	5,10€

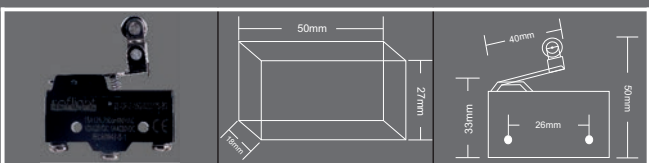

Código	Descrição	Embalagem	P.U.€
SL-CP-Z-15GW227S-B3	Microswitch	200/20	5,50€

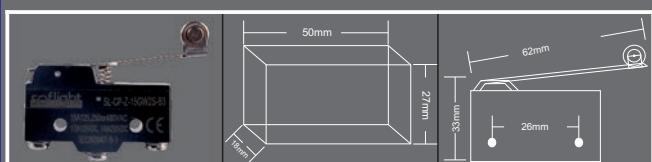

Código	Descrição	Embalagem	P.U.€
SL-CP-Z-15GW2S-B3	Microswitch	200/20	5,40€



Código	Descrição	Embalagem	P.U.€
SL-CP-AP-B	Tampa para Microswitch	200/20	1,35€

## Fins de Curso Metálicos

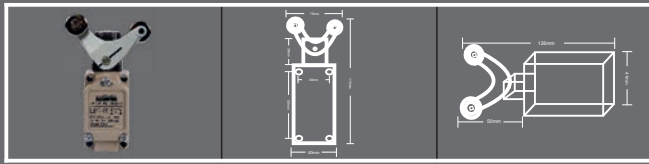

Código	Descrição	Embalagem	P.U.€
SL-CP-WL-CA32-41	Fim de Curso	200/20	24,50€

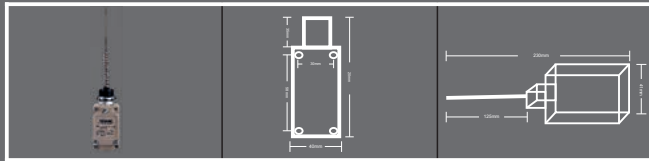

Código	Descrição	Embalagem	P.U.€
SL-CP-WL-NJ-S2	Fim de Curso	200/20	20,15€

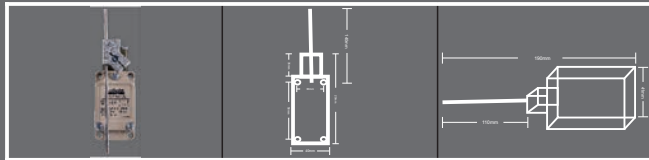

Código	Descrição	Embalagem	P.U.€
SL-CP-WL-CL	Fim de Curso	200/20	20,15€

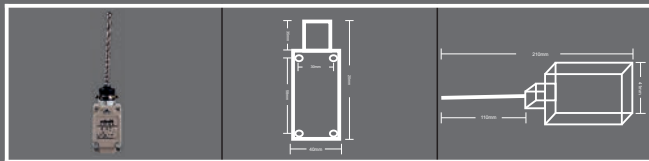

Código	Descrição	Embalagem	P.U.€
SL-CP-WL-NJ	Fim de Curso	200/20	20,15€

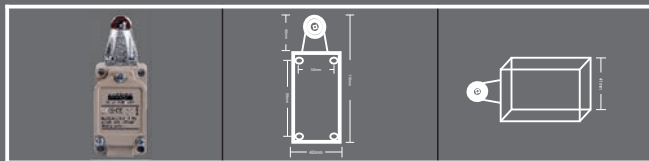

Código	Descrição	Embalagem	P.U.€
SL-CP-WL-D2	Fim de Curso	200/20	20,15€

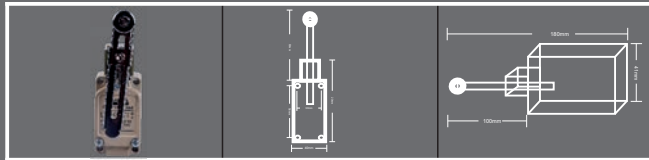

Código	Descrição	Embalagem	P.U.€
SL-CP-WL-CA12-2	Fim de Curso	200/20	20,15€

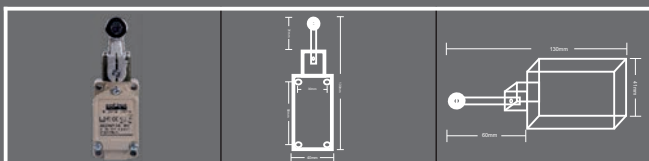

Código	Descrição	Embalagem	P.U.€
SL-CP-WL-CA2-2	Fim de Curso	200/20	20,15€

## Fins de Curso em Plástico

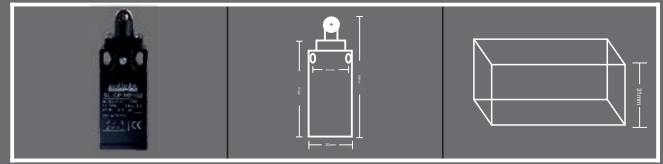

Código	Descrição	Embalagem	P.U.€
SL-CP-MP-102	Fim de Curso	200/20	12,40€

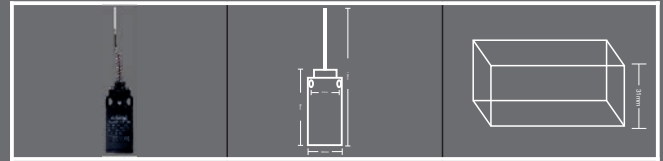

Código	Descrição	Embalagem	P.U.€
SL-CP-MP-106	Fim de Curso	200/20	12,40€

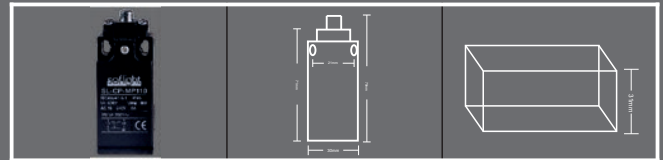

Código	Descrição	Embalagem	P.U.€
SL-CP-MP-110	Fim de Curso	200/20	12,40€

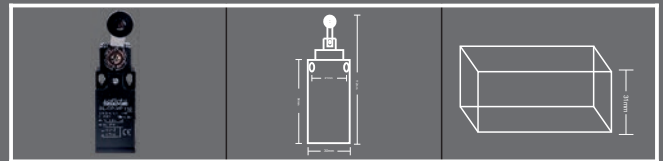

Código	Descrição	Embalagem	P.U.€
SL-CP-MP-118	Fim de Curso	200/20	12,40€

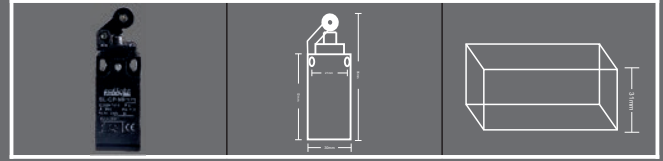

Código	Descrição	Embalagem	P.U.€
SL-CP-MP-121	Fim de Curso	200/20	12,40€

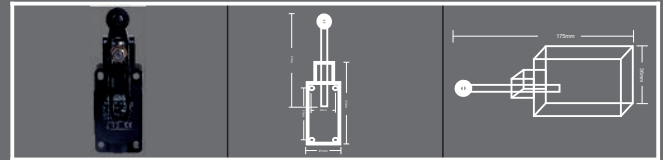

Código	Descrição	Embalagem	P.U.€
SL-CP-MS-141	Fim de Curso	200/20	12,40€

### Fins de Curso Metálicos

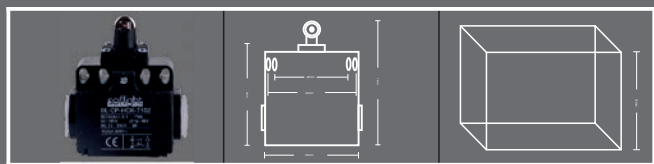

Código	Descrição	Embalagem	P.U.€
SL-CP-HCK-T102	Fim de Curso	200/20	13,50€

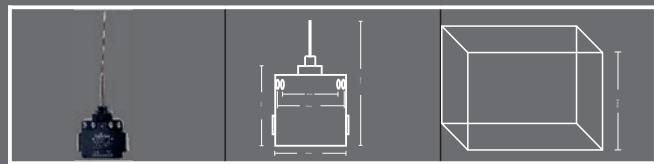

Código	Descrição	Embalagem	P.U.€
SL-CP-HCK-T106	Fim de Curso	200/20	13,50€

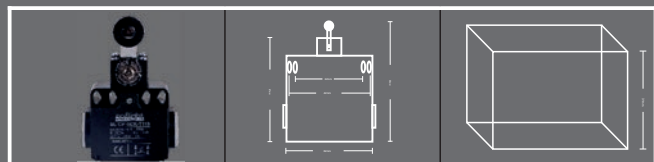

Código	Descrição	Embalagem	P.U.€
SL-CP-HCK-T118	Fim de Curso	200/20	13,50€

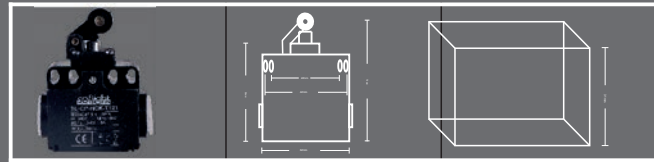

Código	Descrição	Embalagem	P.U.€
SL-CP-HCK-T121	Fim de Curso	200/20	13,50€

### Interruptor Emergência, Montagem Painei ( EN60947-3 )



Código	Polos	AC-21A A	Potência AC3/400V/KW	Emb.	P.U.€
SL-CP65-325	3P	25A	5,5	25	26,50€
SL-CP65-332	3P	32A	7,5	25	34,70€
SL-CP65-340	3P	40A	11	25	47,00€
SL-CP65-363	3P	63A	12,5	25	53,50€
SL-CP65-3100	3P	100A	30	20	68,80€

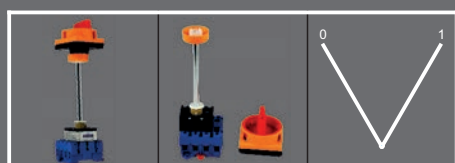

Código	Polos	AC-21A A	Potência AC3/400V/KW	Emb.	P.U.€
SL-CP65-425	4P	25A	5,5	25	34,80€
SL-CP65-432	4P	32A	7,5	25	45,60€
SL-CP65-440	4P	40A	11	25	49,70€
SL-CP65-463	4P	63A	12,5	25	59,50€
SL-CP65-4100	4P	100A	30	20	85,70€

### Interruptor Seccionador Com Caixa IP 65 ( EN60947-3 )



Código	Polos	AC-21A A	Potência AC3/400V/KW	Emb.	P.U.€
SL-CP66-332	3P	32A	7,5	30	42,20€
SL-CP66-363	3P	63A	12,5	20	65,80€
SL-CP66-3100	3P	100A	30	10	148,00€



Código	Polos	AC-21A A	Potência AC3/400V/KW	Emb.	P.U.€
SL-CP66-432	4P	32A	7,5	30	44,80€
SL-CP66-463	4P	63A	12,5	20	99,90€
SL-CP66-4100	4P	100A	30	10	155,00€

### Interruptor Emergência, Montagem Painei ( EN60947-3 )



Código	Polos	AC-21A A	Potência AC3/400V/KW	Emb.	P.U.€
SL-CP67-325	3P	25A	5,5	25	26,60€
SL-CP67-340	3P	40A	11	25	42,20€
SL-CP67-363	3P	63A	12,5	25	45,80€
SL-CP67-3100	3P	100A	30	20	67,90€

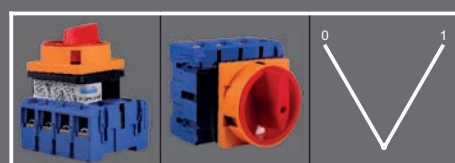

Código	Polos	AC-21A A	Potência AC3/400V/KW	Emb.	P.U.€
SL-CP67-425	4P	25A	5,5	25	32,50€
SL-CP67-440	4P	40A	11	25	48,30€
SL-CP67-463	4P	63A	12,5	25	55,90€
SL-CP67-4100	4P	100A	30	20	82,00€





**SL-L2221-2P**

Ligador Rápido p/fio  
c/ Patilha Flexível 2P  
Quant. Emb.100/7000  
**P.U. 0,25€**

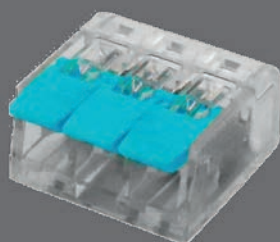

**SL-L2221-3P**

Ligador Rápido p/fio  
c/ Patilha Flexível 3P  
Quant. Emb. 100/7000  
**P.U. 0,33€**

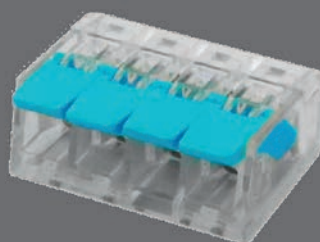

**SL-L2221-4P**

Ligador Rápido p/fio  
c/ Patilha Flexível 4P  
Quant. Emb. 50/3500  
**P.U. 0,41€**



**SL-L2221-5P**

Ligador Rápido p/fio  
c/ Patilha Flexível 5P  
Quant. Emb. 50/3500  
**P.U. 0,47€**



**SL-L1273-2P**

Ligador Rápido p/fio  
Rígido 2P  
Quant. Emb.200/4000  
**P.U. 0,11€**



**SL-L1273-3P**

Ligador Rápido p/fio  
Rígido 3P  
Quant. Emb.200/4000  
**P.U. 0,15€**



**SL-L1273-4P**

Ligador Rápido p/fio  
Rígido 4P  
Quant. Emb.100/7000  
**P.U. 0,17€**



**SL-L1273-5P**

Ligador Rápido p/fio  
Rígido 5P  
Quant. Emb.100/7000  
**P.U. 0,20€**



**SL-L1273-8P**

Ligador Rápido p/fio  
Rígido 8P  
Quant. Emb.100/7000  
**P.U. 0,30€**



**SL-CM16-3P**

Conector M16 / IP 68 / 3P  
Temp. Trab. -40° + 95°  
450V / 15A  
Cabo: Máx 2,5mm2  
Quant. Emb.100Unid.  
**P.U. 4,00€**



**SL-EW-M20-3P**

Conector M20 / IP 68 3P  
Temp. Trab. -40° + 95°  
450V / 15A  
Cabo: Máx 2,5mm2  
Quant. Emb. 10  
**P.U. 7,00€**



**SL-EW-2068-L-T**

Caixa Derivação Vazia  
Temp. Trab. -40° + 95°  
450V / 20A  
Cabo: Máx 2,5mm2  
Quant. Emb. 10  
**P.U. 9,50€**



**SL-EW-M20-X-3P**

Conector M20 / X / IP 68 / 3P  
Temp. Trab. -40° + 95°  
450V / 20A  
Cabo: Máx 2,5mm2  
Quant. Emb. 10  
**P.U. 17,00€**



**SL-CM20-3P**

Conector M20 / IP 68 / 3P  
Temp. Trab. -40° + 95°  
450V / 20A  
Cabo: Máx 2,5mm2  
Quant. Emb.50Unid.  
**P.U. 4,90€**



**SL-EW-M25-5P**

Conector M25 IP / 68 / 5P  
Temp. Trab. -40° + 95°  
450V / 20A  
Cabo: Máx 2,5mm2  
Quant. Emb. 10  
**P.U. 8,90€**



**SL-CM20-T-3P**

Conector M20 T / IP 68 / 3P  
450V / 20A  
Temp. Trab. -40° + 95°  
Cabo: Máx 2,5mm2  
Quant. Emb. 10  
**P.U. 11,00€**



**SL-BJ 1004**

Barra Junção 2,5-4mm  
Quant. Emb.10/1000  
**P.U. 0,60€**



**SL-BJ 1006**

Barra Junção 6mm  
Quant. Emb. 10/1000  
**P.U. 0,75€**



**SL-BJ 1010**

Barra Junção 10mm  
Pquant. Emb. 10/500  
**P.U. 1,05€**



**SL-BJ 1016**

Barra Junção 16mm  
Quant. Emb. 10/500  
**P.U. 2,65€**

### Ponteiras Isoladas



Código	Descrição	Comp.	Cor	Qty. Min. Venda	Preço Unitário
SL-T-E0508	Ponteira 0,50mm	8mm	●	100	0,0116€
SL-T-E05.12	Ponteira 0,50mm	12mm	●	100	0,0156€
SL-T-E7508	Ponteira 0,75mm	8mm	●	100	0,0116€
SL-T-E75.12	Ponteira 0,75mm	12mm	●	100	0,0156€
SL-T-E1008	Ponteira 1,00mm	8mm	●	100	0,0116€
SL-T-E10.12	Ponteira 1,00mm	12mm	●	100	0,0156€
SL-T-E1508	Ponteira 1,50mm	8mm	●	100	0,0126€
SL-T-E15.18	Ponteira 1,50mm	18mm	●	100	0,0260€
SL-T-E2508	Ponteira 2,50mm	8mm	●	100	0,0166€
SL-T-E25.18	Ponteira 2,50mm	18mm	●	100	0,0300€
SL-T-E4009	Ponteira 4,00mm	9mm	●	100	0,0250€
SL-T-E40.18	Ponteira 4,00mm	18mm	●	100	0,0430€
SL-T-E6010	Ponteira 6,00mm	10mm	●	100	0,0350€
SL-T-E60.18	Ponteira 6,00mm	18mm	●	100	0,0580€
SL-T-E1012	Ponteira 10,00mm	12mm	●	100	0,0436€
SL-T-E10.18	Ponteira 10,00mm	18mm	●	100	0,0700€
SL-T-E1612	Ponteira 16,00mm	12mm	●	100	0,0600€
SL-T-E16.18	Ponteira 16,00mm	18mm	●	100	0,0990€
SL-T-E2516	Ponteira 25,00mm	16mm	●	100	0,1150€
SL-T-E25.22	Ponteira 25,00mm	22mm	●	100	0,1580€
SL-T-E3516	Ponteira 35,00mm	16mm	●	100	0,1350€
SL-T-E35.25	Ponteira 35,00mm	25mm	●	100	0,1960€
SL-T-E5020	Ponteira 50,00mm	20mm	●	100	0,2500€
SL-T-E7027	Ponteira 70,00mm	27mm	●	100	0,5000€
SL-T-E9525	Ponteira 95,00mm	25mm	●	100	1,1000€
SL-T-E12027	Ponteira 120,00mm	27mm	●	50	1,4000€

### Ponteiras Duplas Isoladas



Código	Descrição	Cor	Qty. Min. Venda	Preço Unitário
SL-T-TE0508	Ponteira 0,50mm	●	100	0,0200€
SL-T-TE7508	Ponteira 0,75mm	●	100	0,0200€
SL-T-TE1008	Ponteira 1,00mm	●	100	0,0200€
SL-T-TE1508	Ponteira 1,50mm	●	100	0,0280€
SL-T-TE2510	Ponteira 2,50mm	●	100	0,0280€
SL-T-TE4012	Ponteira 4,00mm	●	100	0,0600€
SL-T-TE6014	Ponteira 6,00mm	●	100	0,0800€
SL-T-TE1014	Ponteira 10,00mm	●	100	0,1160€
SL-T-TE1614	Ponteira 16,00mm	●	100	0,1600€

### Terminais Isolados Ponteira



Código	Descrição	Cor	Qty. Min. Venda	Preço Unitário
SL-T-PTV1,25-10	0,5-1,5mm, Pont. 10mm	●	100	0,0460€
SL-T-PTV2-10	1,5-2,5mm, Pont. 10mm	●	100	0,0480€
SL-T-PTV5,5-13	4,0-6,0mm, Ponteira 13mm	●	100	0,0930€

### Terminais Isolados Macho



Código	Descrição	Cor	Qty. Min. Venda	Preço Unitário
SL-T-MDD1,25-110	0,5-1,5mm (2,4mm)	●	100	0,0490€
SL-T-MDD1,25-187	0,5-1,5mm (4,8mm)	●	100	0,0490€
SL-T-MDD1,25-250	0,5-1,5mm (6,3mm)	●	100	0,0490€
SL-T-MDD2-110	1,5-2,5mm (2,4mm)	●	100	0,0500€
SL-T-MDD2-187	1,5-2,5mm (4,8mm)	●	100	0,0500€
SL-T-MDD2-250	1,5-2,5mm (6,3mm)	●	100	0,0500€
SL-T-MDD5,5-250	4,0-6,0mm (6,3mm)	●	100	0,0780€

# Ponteiras / Terminais

### Terminais Isolados Fêmea



Código	Descrição	Cor	Qty. Min. Venda	Preço Unitário
SL-T-FDD1,25-110	0,5-1,5mm (2,4mm)	●	100	0,0460€
SL-T-FDD1,25-187	0,5-1,5mm (4,8mm)	●	100	0,0460€
SL-T-FDD1,25-250	0,5-1,5mm (6,3mm)	●	100	0,0460€
SL-T-FDD2-110	1,5-2,5mm (2,4mm)	●	100	0,0500€
SL-T-FDD2-187	1,5-2,5mm (4,8mm)	●	100	0,0500€
SL-T-FDD2-250	1,5-2,5mm (6,3mm)	●	100	0,0500€
SL-T-FDD5,5-250	4,0-6,0mm (6,3mm)	●	100	0,0660€

### Terminais Isolados M/F



Código	Descrição	Cor	Qty. Min. Venda	Preço Unitário
SL-T-PBDD1,25-250	0,5-1,5mm (6,3mm)	●	100	0,1000€
SL-T-PBDD2-250	1,5-2,5mm (6,3mm)	●	100	0,1100€

### Term. Totalmente Isol. Fêmea



Código	Descrição	Cor	Qty. Min. Venda	Preço Unitário
SL-T-FDFD1,25-110	0,5-1,5mm (2,4mm)	●	100	0,0700€
SL-T-FDFD1,25-187	0,5-1,5mm (4,8mm)	●	100	0,0700€
SL-T-FDFD1,25-250	0,5-1,5mm (6,3mm)	●	100	0,0700€
SL-T-FDFD2-110	0,5-2,5mm (2,4mm)	●	100	0,0800€
SL-T-FDFD2-187	0,5-2,5mm (4,8mm)	●	100	0,0800€
SL-T-FDFD2-250	0,5-2,5mm (6,3mm)	●	100	0,0800€
SL-T-FDFD5,5-250	4,0-6,0mm (6,3mm)	●	100	0,1100€

### Terminais Isolados Forquilha



Código	Descrição	Cor	Qty. Min. Venda	Preço Unitário
SL-T-SVS1,25-4	0,5-1,5mm, Furo 4,3mm	●	100	0,0420€
SL-T-SVS1,25-5	0,5-1,5mm, Furo 5,3mm	●	100	0,0500€
SL-T-SVS1,25-6	0,5-1,5mm, Furo 6,4mm	●	100	0,0510€
SL-T-SVS2-4	1,5-2,5mm, Furo 4,3mm	●	100	0,0515€
SL-T-SVS2-5	1,5-2,5mm, Furo 5,3mm	●	100	0,0520€
SL-T-SVS2-6	1,5-2,5mm, Furo 6,4mm	●	100	0,0540€
SL-T-SVS5,5-4	4,0-6,0mm, Furo 4,3mm	●	100	0,0900€
SL-T-SVS5,5-6	4,0-6,0mm, Furo 6,4mm	●	100	0,0950€
SL-T-SVS5,5-8	4,0-6,0mm, Furo 8,4mm	●	100	0,1160€

### Terminais Isolados de Olhal



Código	Descrição	Cor	Qty. Min. Venda	Preço Unitário
SL-T-RVS1,25-4	0,5-1,5mm, Furo 4,3mm	●	100	0,0410€
SL-T-RVS1,25-5	0,5-1,5mm, Furo 5,3mm	●	100	0,0410€
SL-T-RVS1,25-6	0,5-1,5mm, Furo 6,4mm	●	100	0,0560€
SL-T-RVS2-4	1,5-2,5mm, Furo 4,3mm	●	100	0,0390€
SL-T-RVS2-5	1,5-2,5mm, Furo 5,3mm	●	100	0,0520€
SL-T-RVS2-6	1,5-2,5mm, Furo 6,4mm	●	100	0,0580€
SL-T-RVS5,5-4	4,0-6,0mm, Furo 4,3mm	●	100	0,0870€
SL-T-RVS5,5-6	4,0-6,0mm, Furo 6,4mm	●	100	0,0960€
SL-T-RVS5,5-8	4,0-6,0mm, Furo 8,4mm	●	100	0,1160€

### Terminais Isolados União



Código	Descrição	Cor	Qty. Min. Venda	Preço Unitário
SL-T-BV1,25	0,5-1,5mm	●	100	0,0550€
SL-T-BV2	0,5-2,5mm	●	100	0,0600€
SL-T-BV5,5	4,0-6,0mm	●	100	0,0900€

# Terminais



União Cega Isolada  
Material: Nylon PA6.6  
Flamabilidade: 94V-2  
Temperatura trabalho: -30 / 80° C

Novos  
Podutos

Código	Descrição	Dimensão	Cor	Quantidade Min.Venda	Preço Unitário
SL-T-UCI-T3	União Cega Isolada 17,8mm	1,25mm <sup>2</sup>	Branca	100 Unid.	0,021€
SL-T-UCI-T4	União Cega Isolada 21,0mm	2mm <sup>2</sup>	Branca	100 Unid.	0,022€
SL-T-UCI-T5	União Cega Isolada 22,5mm	5,5mm <sup>2</sup>	Branca	100 Unid.	0,030€
SL-T-UCI-T6	União Cega Isolada 25,0mm	8mm <sup>2</sup>	Branca	100 Unid.	0,036€
SL-T-UCI-T8	União Cega Isolada 25,6mm	13mm <sup>2</sup>	Branca	100 Unid.	0,073€
SL-T-UCI-T10	União Cega Isolada 29,5mm	16mm <sup>2</sup>	Branca	100 Unid.	0,125€

## Terminais de Cobre Eletrolíticos, Estanhados



Novos  
Podutos



Novos  
Podutos

Código	Descrição	Furo	Qty Min.Venda	P.U.	Código	Descrição	Furo Ø	Qty Min.Venda	P.U.
SL-T-CO-1,5-4	Terminal 1,5mm <sup>2</sup>	4mm	100	0,106€	SL-T-CO-95-8	Terminal 95mm <sup>2</sup>	8mm	20	2,116€
SL-T-CO-1,5-5	Terminal 1,5mm <sup>2</sup>	5mm	100	0,101€	SL-T-CO-95-10	Terminal 95mm <sup>2</sup>	10mm	20	2,080€
SL-T-CO-1,5-6	Terminal 1,5mm <sup>2</sup>	6mm	100	0,101€	SL-T-CO-95-12	Terminal 95mm <sup>2</sup>	12mm	20	2,090€
SL-T-CO-2,5-4	Terminal 2,5mm <sup>2</sup>	4mm	100	0,113€	SL-T-CO-95-14	Terminal 95mm <sup>2</sup>	14mm	20	2,040€
SL-T-CO-2,5-5	Terminal 2,5mm <sup>2</sup>	5mm	100	0,113€	SL-T-CO-95-16	Terminal 95mm <sup>2</sup>	16mm	20	3,240€
SL-T-CO-2,5-6	Terminal 2,5mm <sup>2</sup>	6mm	100	0,118€	SL-T-CO-95-20	Terminal 95mm <sup>2</sup>	20mm	20	3,100€
SL-T-CO-2,5-8	Terminal 2,5mm <sup>2</sup>	8mm	100	0,118€	SL-T-CO-120-8	Terminal 120mm <sup>2</sup>	8mm	5	5,700€
SL-T-CO-4-4	Terminal 4mm <sup>2</sup>	4mm	100	0,156€	SL-T-CO-120-10	Terminal 120mm <sup>2</sup>	10mm	5	3,250€
SL-T-CO-4-5	Terminal 4mm <sup>2</sup>	5mm	100	0,150€	SL-T-CO-120-12	Terminal 120mm <sup>2</sup>	12mm	5	3,450€
SL-T-CO-4-6	Terminal 4mm <sup>2</sup>	6mm	100	0,156€	SL-T-CO-120-14	Terminal 120mm <sup>2</sup>	14mm	5	3,550€
SL-T-CO-4-8	Terminal 4mm <sup>2</sup>	8mm	100	0,184€	SL-T-CO-120-16	Terminal 120mm <sup>2</sup>	16mm	5	3,500€
SL-T-CO-6-6	Terminal 6mm <sup>2</sup>	6mm	100	0,165€	SL-T-CO-120-20	Terminal 120mm <sup>2</sup>	20mm	5	4,850€
SL-T-CO-6-8	Terminal 6mm <sup>2</sup>	8mm	100	0,220€	SL-T-CO-150-10	Terminal 150mm <sup>2</sup>	10mm	5	4,330€
SL-T-CO-6-10	Terminal 6mm <sup>2</sup>	10mm	100	0,210€	SL-T-CO-150-12	Terminal 150mm <sup>2</sup>	12mm	5	4,330€
SL-T-CO-10-6	Terminal 10mm <sup>2</sup>	6mm	100	0,174€	SL-T-CO-150-14	Terminal 150mm <sup>2</sup>	14mm	5	4,330€
SL-T-CO-10-8	Terminal 10mm <sup>2</sup>	8mm	100	0,380€	SL-T-CO-150-16	Terminal 150mm <sup>2</sup>	16mm	5	4,220€
SL-T-CO-10-10	Terminal 10mm <sup>2</sup>	10mm	100	0,370€	SL-T-CO-150-20	Terminal 150mm <sup>2</sup>	20mm	5	5,910€
SL-T-CO-10-12	Terminal 10mm <sup>2</sup>	12mm	100	0,400€	SL-T-CO-185-10	Terminal 185mm <sup>2</sup>	10mm	5	9,110€
SL-T-CO-16-5	Terminal 16mm <sup>2</sup>	5mm	100	0,400€	SL-T-CO-185-12	Terminal 185mm <sup>2</sup>	12mm	5	6,000€
SL-T-CO-16-6	Terminal 16mm <sup>2</sup>	6mm	100	0,280€	SL-T-CO-185-14	Terminal 185mm <sup>2</sup>	14mm	5	6,220€
SL-T-CO-16-8	Terminal 16mm <sup>2</sup>	8mm	100	0,280€	SL-T-CO-185-16	Terminal 185mm <sup>2</sup>	16mm	5	7,330€
SL-T-CO-16-10	Terminal 16mm <sup>2</sup>	10mm	100	0,400€	SL-T-CO-185-20	Terminal 185mm <sup>2</sup>	20mm	5	8,490€
SL-T-CO-16-12	Terminal 16mm <sup>2</sup>	16mm	100	0,462€	SL-T-CO-240-10	Terminal 240mm <sup>2</sup>	10mm	5	11,110€
SL-T-CO-25-6	Terminal 25mm <sup>2</sup>	6mm	100	0,411€	SL-T-CO-240-12	Terminal 240mm <sup>2</sup>	12mm	5	7,800€
SL-T-CO-25-8	Terminal 25mm <sup>2</sup>	8mm	100	0,422€	SL-T-CO-240-14	Terminal 240mm <sup>2</sup>	14mm	5	7,650€
SL-T-CO-25-10	Terminal 25mm <sup>2</sup>	10mm	100	0,500€	SL-T-CO-240-16	Terminal 240mm <sup>2</sup>	16mm	5	7,710€
SL-T-CO-25-12	Terminal 25mm <sup>2</sup>	12mm	100	0,693€	SL-T-CO-240-20	Terminal 240mm <sup>2</sup>	20mm	5	10,580€
SL-T-CO-35-6	Terminal 35mm <sup>2</sup>	6mm	50	0,645€	SL-T-CO-300-12	Terminal 300mm <sup>2</sup>	12mm	5	12,845€
SL-T-CO-35-8	Terminal 35mm <sup>2</sup>	8mm	50	0,711€	SL-T-CO-300-14	Terminal 300mm <sup>2</sup>	14mm	5	12,670€
SL-T-CO-35-10	Terminal 35mm <sup>2</sup>	10mm	50	0,733€	SL-T-CO-300-16	Terminal 300mm <sup>2</sup>	16mm	5	12,540€
SL-T-CO-35-12	Terminal 35mm <sup>2</sup>	12mm	50	1,030€	SL-T-CO-300-20	Terminal 300mm <sup>2</sup>	20mm	5	12,250€
SL-T-CO-35-14	Terminal 35mm <sup>2</sup>	14mm	50	1,200€	SL-T-CO-400-12	Terminal 400mm <sup>2</sup>	12mm	1	19,020€
SL-T-CO-35-16	Terminal 35mm <sup>2</sup>	16mm	50	1,138€	SL-T-CO-400-14	Terminal 400mm <sup>2</sup>	14mm	1	18,850€
SL-T-CO-50-6	Terminal 50mm <sup>2</sup>	6mm	20	0,900€	SL-T-CO-400-16	Terminal 400mm <sup>2</sup>	16mm	1	18,650€
SL-T-CO-50-8	Terminal 50mm <sup>2</sup>	8mm	20	1,000€	SL-T-CO-400-20	Terminal 400mm <sup>2</sup>	20mm	1	18,250€
SL-T-CO-50-10	Terminal 50mm <sup>2</sup>	10mm	20	1,070€	SL-T-CO-500-12	Terminal 500mm <sup>2</sup>	12mm	1	24,900€
SL-T-CO-50-12	Terminal 50mm <sup>2</sup>	12mm	20	1,090€	SL-T-CO-500-14	Terminal 500mm <sup>2</sup>	14mm	1	24,900€
SL-T-CO-50-14	Terminal 50mm <sup>2</sup>	14mm	20	1,764€	SL-T-CO-500-16	Terminal 500mm <sup>2</sup>	16mm	1	24,450€
SL-T-CO-50-16	Terminal 50mm <sup>2</sup>	16mm	20	3,270€	SL-T-CO-500-20	Terminal 500mm <sup>2</sup>	20mm	1	24,000€
SL-T-CO-50-20	Terminal 50mm <sup>2</sup>	20mm	20	3,390€	SL-T-CO-600-12	Terminal 600mm <sup>2</sup>	12mm	1	36,000€
SL-T-CO-70-8	Terminal 70mm <sup>2</sup>	8mm	20	1,445€	SL-T-CO-600-14	Terminal 600mm <sup>2</sup>	14mm	1	36,000€
SL-T-CO-70-10	Terminal 70mm <sup>2</sup>	10mm	20	1,511€	SL-T-CO-600-16	Terminal 600mm <sup>2</sup>	16mm	1	36,000€
SL-T-CO-70-12	Terminal 70mm <sup>2</sup>	12mm	20	1,511€	SL-T-CO-600-20	Terminal 600mm <sup>2</sup>	20mm	1	36,000€
SL-T-CO-70-14	Terminal 70mm <sup>2</sup>	14mm	20	2,650€					
SL-T-CO-70-16	Terminal 70mm <sup>2</sup>	16mm	20	2,693€					
SL-T-CO-70-20	Terminal 70mm <sup>2</sup>	20mm	20	2,436€					

## União de Cobre Electric

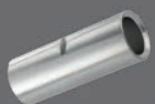

Novos Podutos

Código	Descrição	Secção	Comprim.	Qty. Min. Venda	P.U.
SL-T-UCO-1,5	União Cravar 1,5mm2	30mm	100	0,168€	
SL-T-UCO-2,5	União Cravar 2,5mm2	30mm	100	0,207€	
SL-T-UCO-4	União Cravar 4mm2	30mm	100	0,257€	
SL-T-UCO-6	União Cravar 6mm2	30mm	100	0,292€	
SL-T-UCO-10	União Cravar 10mm2	30mm	100	0,346€	
SL-T-UCO-16	União Cravar 16mm2	35mm	100	0,490€	
SL-T-UCO-25	União Cravar 25mm2	40mm	50	0,735€	
SL-T-UCO-35	União Cravar 35mm2	45mm	50	1,030€	
SL-T-UCO-50	União Cravar 50mm2	50mm	25	1,540€	
SL-T-UCO-70	União Cravar 70mm2	55mm	25	2,090€	
SL-T-UCO-95	União Cravar 95mm2	60mm	10	3,030€	
SL-T-UCO-120	União Cravar 120mm2	65mm	10	4,380€	
SL-T-UCO-150	União Cravar 150mm2	70mm	10	5,220€	
SL-T-UCO-185	União Cravar 185mm2	75mm	10	7,110€	
SL-T-UCO-240	União Cravar 240mm2	80mm	10	8,670€	
SL-T-UCO-300	União Cravar 300mm2	85mm	1	12,310€	
SL-T-UCO-400	União Cravar 400mm2	90mm	1	26,660€	
SL-T-UCO-500	União Cravar 500mm2	100mm	1	33,330€	
SL-T-UCO-630	União Cravar 630mm2	110mm	1	46,660€	

## União Alumínio



Novos Podutos

Código	Descrição	Secção	Qty. Min. Venda	P.U.
SL-T-UA-10	União Alumínio 10mm2 x 60mm	100	1,40€	
SL-T-UA-16	União Alumínio 16mm2 x 65mm	100	1,40€	
SL-T-UA-25	União Alumínio 25mm2 x 70mm	100	1,00€	
SL-T-UA-35	União Alumínio 35mm2 x 75mm	100	1,25€	
SL-T-UA-50	União Alumínio 50mm2 x 80mm	100	1,40€	
SL-T-UA-70	União Alumínio 70mm2 x 90mm	100	1,67€	
SL-T-UA-95	União Alumínio 95mm2 x 95mm	100	1,82€	
SL-T-UA-120	União Alumínio 120mm2 x 100mm	100	2,67€	
SL-T-UA-150	União Alumínio 150mm2 x 105mm	100	3,00€	
SL-T-UA-185	União Alumínio 185mm2 x 110mm	100	4,40€	
SL-T-UA-240	União Alumínio 240mm2 x 120mm	100	5,00€	
SL-T-UA-300	União Alumínio 300mm2 x 130mm	100	6,55€	
SL-T-UA-400	União Alumínio 400mm2 x 140mm	100	13,50€	

## Traça Cobre Estanhada Plana



Novos Podutos

Código	Descrição	Qty. Min. Venda	P.U./mt
SL-T-TC-6	Traça Cobre Plana 6mm2	Rolo/25mts	5,50€
SL-T-TC-10	Traça Cobre Plana 10mm2	Rolo/25mts	8,90€
SL-T-TC-16	Traça Cobre Plana 16mm2	Rolo/25mts	14,50€
SL-T-TC-25	Traça Cobre Plana 25mm2	Rolo/25mts	22,50€

## Borne Terra em Cobre



Novos Podutos

Código	Descrição	Emb.	P.U.
SL-T-BT-16	Borne Terra para Fio 16mm	100	3,60€
SL-T-BT-25	Borne Terra para Fio 25mm	50	4,90€
SL-T-BT-35	Borne Terra para Fio 35mm	50	6,90€

## Kit Termorretrátil com Resina

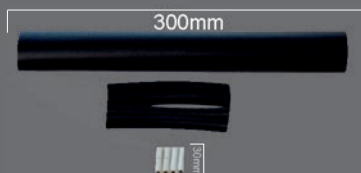

Novos Podutos

Código	Descrição	Qt.Embalagem	P.U.
SL-MRCR-KIT-4x2,5	Kit, União Termorretractil, Tubo 25,4mmx300mm / 4 Uniões 2,5mm2 x 30mm	250 Unidades	4,250€

# Terminais

## Terminais Bimetálicos



Novos Podutos

Código	Descrição	FuroØ	Comp.	Qty. Min. Venda	P.U.
SL-T-BIM-16-11	Terminal 16mm2	11mm	80mm	20	3,050€
SL-T-BIM-25-11	Terminal 25mm2	11mm	80mm	20	3,100€
SL-T-BIM-35-11	Terminal 35mm2	11mm	80mm	20	3,130€
SL-T-BIM-50-13	Terminal 50mm2	13mm	90mm	10	3,550€
SL-T-BIM-70-13	Terminal 70mm2	13mm	90mm	10	3,550€
SL-T-BIM-95-13	Terminal 95mm2	13mm	90mm	10	3,550€
SL-T-BIM-120-13	Terminal 120mm2	13mm	115mm	5	5,690€
SL-T-BIM-150-13	Terminal 150mm2	13mm	115mm	5	5,690€
SL-T-BIM-185-13	Terminal 185mm2	13mm	120mm	5	9,910€
SL-T-BIM-240-13	Terminal 240mm2	13mm	120mm	5	9,910€
SL-T-BIM-300-13	Terminal 300mm2	13mm	130mm	3	15,350€
SL-T-BIM-400-17	Terminal 400mm2	17mm	160mm	3	19,850€
SL-T-BIM-500-17	Terminal 500mm2	17mm	160mm	3	29,750€
SL-T-BIM-630-17	Terminal 630mm2	17mm	180mm	2	65,000€

## Ligador de Derivação de Aperto Simultâneo para derivações rede de Torçada até 6Kv



Novos Podutos

Código	Secção mm2 Principal	Secção mm2 Derivação	Embalagem	P.U.
SL-T-LD10-95	10 - 95mm	1,5 - 10mm	12	2,95€
SL-T-LD16-95	10 - 95mm	4 - 35mm	12	4,00€

## Bornes em Poliamida



Novos Podutos

Código	Descrição	Emb	P.U.
SL-T-BP-16	Barra Bornes Poliamida 16mm	10	11,00€
SL-T-BP-25	Barra Bornes Poliamida 25mm	10	15,50€
SL-T-BP-35	Barra Bornes Poliamida 35mm	10	22,80€

## Isoladores Hexagonais



Novos Podutos

Código	Descrição	Qty. Min. Venda	P.U.
SL-T-IH-20	Isolador M5 x 20mm	Rolo/25mts	1,20€
SL-T-IH-25	Isolador M6 x 25mm	Rolo/25mts	1,10€
SL-T-IH-35	Isolador M8 x 35mm	Rolo/25mts	1,70€
SL-T-IH-45	Isolador M8 x 45mm	Rolo/25mts	2,35€
SL-T-IH-76	Isolador M10 x 76mm	Rolo/25mts	6,85€

# Mangas Termorretráteis

Tubo Poliolefina em Rolo sem Resina

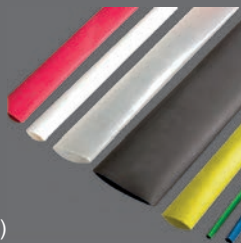

Novos Podutos

**CORES:** ...PT (Preto) CT (Castanho) CZ (Cinza) AZ (Azul) VD (Verde)  
VM (Vermelho) AZ (Azul) TR (Transparente) VA (Verde/Amarelo) BR (Branco)

Dimensão antes Retração Diam. Interior	Dimensão antes Retração		Dimensão após Retração		Aplicação	Qt.Min. Venda		P.U.	
	Espes. Parede	Dimensão após Retração	Dimensão após Retração	Espes. Parede		Qt.Min. Venda	P.U.		
1,7+/- 0,3 / 0,20 +/- 0,05mm	0,100€	0,100€	0,73 +/- 0,1mm / 0,32+/-0,05	0,100€	0,95-1,4mm	Saco c/ 100 Tubos	0,100€	0,340€	0,100€
<b>Códigos:</b> SL-MRSR-1,5PT / SL-MRSR-1,5CT / SL-MRSR-1,5CZ / SL-MRSR-1,5AZ / SL-MRSR-1,5VD / SL-MRSR-1,5VM / SL-MRSR-1,5AM / SL-MRSR-1,5TR / SL-MRSR-1,5VA / SL-MRSR-1,5BR									
2,2 +/- 0,3 / 0,25 +/- 0,05mm	0,110€	0,110€	0,98 +/- 0,1mm / 0,32+/-0,05	0,110€	1,1-1,8mm	Saco c/ 100 Tubos	0,110€	0,311€	0,110€
<b>Códigos:</b> SL-MRSR-2,0PT / SL-MRSR-2,0CT / SL-MRSR-2,0CZ / SL-MRSR-2,0AZ / SL-MRSR-2,0VD / SL-MRSR-2,0VM / SL-MRSR-2,0AM / SL-MRSR-2,0TR / SL-MRSR-2,0VA / SL-MRSR-2,0BR									
3,2 +/- 0,4 / 0,25 +/- 0,05mm	0,140€	0,140€	1,45 +/- 0,2mm / 0,35+/-0,05	0,140€	1,6-2,7mm	Saco c/ 100 Tubos	0,140€	0,270€	0,140€
<b>Códigos:</b> SL-MRSR-3,0PT / SL-MRSR-3,0CT / SL-MRSR-3,0CZ / SL-MRSR-3,0AZ / SL-MRSR-3,0VD / SL-MRSR-3,0VM / SL-MRSR-3,0AM / SL-MRSR-3,0TR / SL-MRSR-3,0VA / SL-MRSR-3,0BR									
4,2 +/- 0,4 / 0,25 +/- 0,05mm	0,182€	0,182€	1,96 +/- 0,2mm / 0,35+/-0,05	0,182€	2,1-3,6mm	Saco c/ 100 Tubos	0,182€	0,289€	0,182€
<b>Códigos:</b> SL-MRSR-4,0PT / SL-MRSR-4,0CT / SL-MRSR-4,0CZ / SL-MRSR-4,0AZ / SL-MRSR-4,0VD / SL-MRSR-4,0VM / SL-MRSR-4,0AM / SL-MRSR-4,0TR / SL-MRSR-4,0VA / SL-MRSR-4,0BR									
6,2 +/- 0,4 / 0,28 +/- 0,15mm	0,266€	0,266€	2,96 +/- 0,3mm / 0,45+/-0,15	0,266€	3,1-5,4mm	Saco c/ 100 Tubos	0,266€	0,333€	0,266€
<b>Códigos:</b> SL-MRSR-6,0PT / SL-MRSR-6,0CT / SL-MRSR-6,0CZ / SL-MRSR-6,0AZ / SL-MRSR-6,0VD / SL-MRSR-6,0VM / SL-MRSR-6,0AM / SL-MRSR-6,0TR / SL-MRSR-6,0VA / SL-MRSR-6,0BR									
10,2 +/- 0,5 / 0,30 +/- 0,15mm	0,316€	0,316€	4,90 +/- 0,3mm / 0,50+/-0,15	0,316€	5,2-9,0mm	Saco c/ 100 Tubos	0,316€	0,466€	0,316€
<b>Códigos:</b> SL-MRSR-10PT / SL-MRSR-10CT / SL-MRSR-10CZ / SL-MRSR-10AZ / SL-MRSR-10VD / SL-MRSR-10VM / SL-MRSR-10AM / SL-MRSR-10TR / SL-MRSR-10VA / SL-MRSR-10BR									
12,2 +/- 0,5 / 0,30 +/- 0,15mm	0,367€	0,367€	5,90 +/- 0,5mm / 0,50+/-0,15	0,367€	6,2-11mm	Saco c/ 100 Tubos	0,367€	0,593€	0,367€
<b>Códigos:</b> SL-MRSR-12PT / SL-MRSR-12CT / SL-MRSR-12CZ / SL-MRSR-12AZ / SL-MRSR-12VD / SL-MRSR-12VM / SL-MRSR-12AM / SL-MRSR-12TR / SL-MRSR-12VA / SL-MRSR-12BR									
16,2 +/- 0,6 / 0,38 +/- 0,15mm	0,622€	0,622€	7,90 +/- 0,5mm / 0,60+/-0,15	0,622€	8,3-15mm	Saco c/ 50 Tubos	0,622€	0,944€	0,622€
<b>Códigos:</b> SL-MRSR-16PT / SL-MRSR-16CT / SL-MRSR-16CZ / SL-MRSR-16AZ / SL-MRSR-16VD / SL-MRSR-16VM / SL-MRSR-16AM / SL-MRSR-16TR / SL-MRSR-16VA / SL-MRSR-16BR									
20,2 +/- 0,8 / 0,40 +/- 0,20mm	1,010€	1,010€	9,90 +/- 0,5mm / 0,70+/-0,20	1,010€	11,4-19mm	Saco c/ 50 Tubos	1,010€	1,200€	1,010€
<b>Códigos:</b> SL-MRSR-20PT / SL-MRSR-20CT / SL-MRSR-20CZ / SL-MRSR-20AZ / SL-MRSR-20VD / SL-MRSR-20VM / SL-MRSR-20AM / SL-MRSR-20TR / SL-MRSR-20VA / SL-MRSR-20BR									
25,3 +/- 0,8 / 0,45 +/- 0,20mm	1,330€	1,330€	12,30 +/- 1,0mm / 0,70+/-0,20	1,330€	12,8-24mm	Saco c/ 25 Tubos	1,330€	1,770€	1,330€
<b>Códigos:</b> SL-MRSR-25PT / SL-MRSR-25CT / SL-MRSR-25CZ / SL-MRSR-25AZ / SL-MRSR-25VD / SL-MRSR-25VM / SL-MRSR-25AM / SL-MRSR-25TR / SL-MRSR-25VA / SL-MRSR-25BR									
30,2 +/- 0,8 / 0,45 +/- 0,20mm	1,750€	1,750€	14,7 +/- 1,0mm / 0,70+/-0,20	1,750€	16,29mm	Saco c/ 25 Tubos	1,750€	2,350€	1,750€
<b>Códigos:</b> SL-MRSR-30PT / SL-MRSR-30CT / SL-MRSR-30CZ / SL-MRSR-30AZ / SL-MRSR-30VD / SL-MRSR-30VM / SL-MRSR-30AM / SL-MRSR-30TR / SL-MRSR-30VA / SL-MRSR-30BR									
40,0 +/- 1,0 / 1,0 +/- 0,20mm	2,450€	2,450€	19,80 +/- 1,0mm / 0,80+/-0,20	2,450€	21-39mm	Saco c/ 25 Tubos	2,450€	3,310€	2,450€
<b>Códigos:</b> SL-MRSR-40PT / SL-MRSR-40CT / SL-MRSR-40CZ / SL-MRSR-40AZ / SL-MRSR-40VD / SL-MRSR-40VM / SL-MRSR-40AM / SL-MRSR-40TR / SL-MRSR-40VA / SL-MRSR-40BR									
50,0 +/- 1,0 / 0,50 +/- 0,20mm	2,956€	2,956€	24,80 +/- 1,0mm / 0,80+/-0,20	2,956€	26-49mm	Saco c/ 25 Tubos	2,956€	4,547€	2,956€
<b>Códigos:</b> SL-MRSR-50PT / SL-MRSR-50CT / SL-MRSR-50CZ / SL-MRSR-50AZ / SL-MRSR-50VD / SL-MRSR-50VM / SL-MRSR-50AM / SL-MRSR-50TR / SL-MRSR-50VA / SL-MRSR-50BR									
60,0 +/- 1,0 / 0,60 +/- 0,20mm	3,890€	3,890€	29,80 +/- 1,0mm / 0,80+/-0,20	3,890€	35-55mm	Saco c/ 10 Tubos	3,890€	6,347€	3,890€
<b>Códigos:</b> SL-MRSR-60PT / SL-MRSR-60CT / SL-MRSR-60CZ / SL-MRSR-60AZ / SL-MRSR-60VD / SL-MRSR-60VM / SL-MRSR-60AM / SL-MRSR-60TR / SL-MRSR-60VA / SL-MRSR-60BR									
80,0 +/- 1,0 / 0,65 +/- 0,20mm	5,445€	5,445€	39,0 +/- 2,0mm / 1,0+/-0,20	5,445€	45-75mm	Saco c/ 10 Tubos	5,445€	10,420€	5,445€
<b>Códigos:</b> SL-MRSR-80PT / SL-MRSR-80CT / SL-MRSR-80CZ / SL-MRSR-80AZ / SL-MRSR-80VD / SL-MRSR-80VM / SL-MRSR-80AM / SL-MRSR-80TR / SL-MRSR-80VA / SL-MRSR-80BR									
100,0 +/- 2,0 / 0,65 +/- 0,20mm	7,780€	7,780€	49,0 +/- 2,0mm / 1,0+/-0,20	7,780€	55-95mm	Saco c/ 10 Tubos	7,780€	15,980€	7,780€
<b>Códigos:</b> SL-MRSR-100PT / SL-MRSR-100CT / SL-MRSR-100CZ / SL-MRSR-100AZ / SL-MRSR-100VD / SL-MRSR-100VM / SL-MRSR-100AM / SL-MRSR-100TR / SL-MRSR-100VA / SL-MRSR-100BR									

## Tubo Termorretrátil com Resina

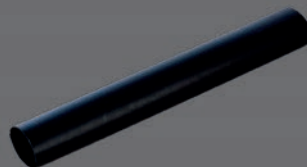

Novos Podutos

Código	Dimensão antes Retração	Espes. Parede	Dimensão após Retração	Aplicação	Qt.Min. Venda	P.U.
			Espes. Parede			
SL-MRCR-4,8	4,8 +/- 0,5mm	1,0 +/- 0,15mm	0,40 +/- 0,1mm / 1,6mm	1,8-4,6mm	Saco c/ 50 Tubos	0,720€
SL-MRCR-6,4	6,4 +/- 0,5mm	1,2 +/- 0,15mm	0,45 +/- 0,10mm / 2,2mm	2,4-6,4mm	Saco c/ 50 Tubos	0,800€
SL-MRCR-7,9	8,0 +/- 0,5mm	1,3 +/- 0,15mm	0,50 +/- 0,12mm / 2,7mm	2,9-7,7mm	Saco c/ 50 Tubos	1,000€
SL-MRCR-12,7	12,8 +/- 0,8mm	1,6 +/- 0,20mm	0,50 +/- 0,12mm / 4,2mm	4,4-12,5mm	Saco c/ 10 Tubos	1,300€
SL-MRCR-15,0	15,0 +/- 0,8mm	1,8 +/- 0,20mm	0,55 +/- 0,12mm / 5,2mm	5,4-14,8mm	Saco c/ 10 Tubos	1,800€
SL-MRCR-19,1	19,6 +/- 0,8mm	2,0 +/- 0,20mm	0,55 +/- 0,12mm / 6,3mm	6,5-18,8mm	Saco c/ 10 Tubos	2,600€
SL-MRCR-25,4	25,4 +/- 0,8mm	2,1 +/- 0,20mm	0,55 +/- 0,15mm / 8,5mm	8,8-25mm	Saco c/ 10 Tubos	3,350€
SL-MRCR-30,0	30,5 +/- 0,8mm	2,2 +/- 0,20mm	0,60 +/- 0,15mm / 10,2mm	10,5-30mm	Saco c/ 10 Tubos	3,350€
SL-MRCR-39,0	39,8 +/- 0,8mm	2,4 +/- 0,20mm	0,60 +/- 0,15mm / 13,5mm	14,0-39mm	Saco c/ 10 Tubos	4,800€
SL-MRCR-50,0	50,0 +/- 0,8mm	2,7 +/- 0,25mm	0,70 +/- 0,15mm / 17,0mm	17,5-49mm	Saco c/ 10 Tubos	6,200€

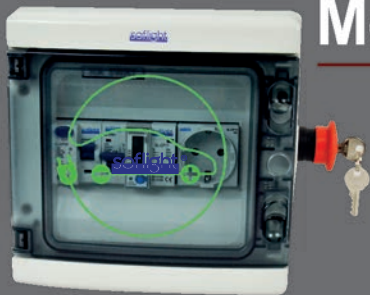

# Mobilidade Elétrica

## Quadro Mobilidade Elétrica Monofásico, 16A(3,5Kw) Sem Contador Energia

Constituído por:

### Interruptor Diferencial Monofásico **Tipo A**

- Disjuntor Unipolar
- Contactor Modular
- Tomada Schuko Modular
- Botoneira Emergência com Chave

Código	P.U.€
Codigo: QE-QMEM-01-16A	190,00€

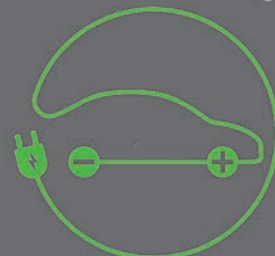

Adequado para Carregadores Portateis

## Quadro Mobilidade Elétrica Monofásico, 16A(3,5Kw) Com Contador Energia

Constituído por:

### Interruptor Diferencial Monofásico **Tipo A**

- Contador Energia Modular Monofásico Modbus RS 485
- Disjuntor Unipolar
- Contactor Modular
- Tomada Schuko Modular
- Botoneira Emergência com Chave

Código	P.U.€
Codigo: QE-QMEM-02-16A	215,00€

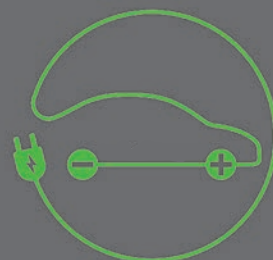

Adequado para Carregadores Portateis

## Quadro Mobilidade Elétrica Monofásico, 32A(7,4Kw) Sem Contador Energia

Constituído por:

### Interruptor Diferencial Monofásico **Tipo A + DC**

- Disjuntor Unipolar
- Contactor Modular
- Botoneira Emergência com Chave

Novos  
Podutos

Código	P.U.€
Codigo: QE-QMEM-03-32ADIFA	230,00€

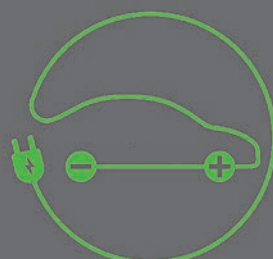

Adequado para Wall Box Monofásicas até 7,4KW

## Quadro Mobilidade Elétrica Monofásico, 32A(7,4Kw) Com Contador Energia

Constituído por:

### Interruptor Diferencial Monofásico **Tipo A + DC**

- Contador Energia Modular Monofásico Modbus RS 485
- Disjuntor Unipolar
- Contactor Modular
- Botoneira Emergência com Chave

Novos  
Podutos

Código	P.U.€
Codigo: QE-QMEM-04-32ADIFA	300,00€

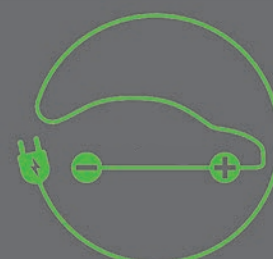

Adequado para Wall Box Monofásicas até 7,4KW



## Quadro Mobilidade Elétrica Trifásico, 32A(22Kw)Sem Contador Energia

Constituído por:

### Interruptor Diferencial Trifásico **Tipo A + DC**

Disjuntor Tetrapolar  
Contactor Modular  
Botoneira Emergência com Chave

Novos  
Podutos

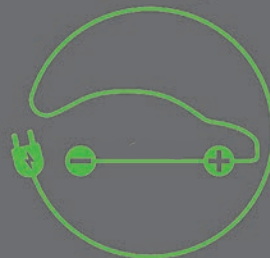

Adequado para Wall Box Trifásica até 22KW

Código	P.U.€
QE-QMET-01-32ADIFA	360,00€

## Quadro Mobilidade Elétrica Trifásico, 32A(22KW) Com Contador Energia

Constituído por:

### Interruptor Diferencial Trifásico **Tipo A + DC**

Contador Energia Modular Trifásico Modbus RS 485  
Disjuntor Tetrapolar  
Contactor Modular  
Botoneira Emergência com Chave

Novos  
Podutos

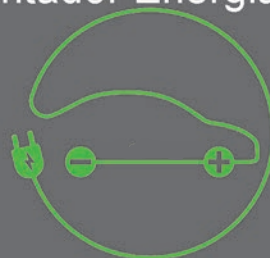

Adequado para Wall Box Trifásica até 22KW

Código	P.U.€
QE-QMET-02-32ADIFA	450,00€

## Quadro Mobilidade Elétrica Trifásico, 32A(22Kw)Sem Contador Energia

Constituído por:

### Interruptor Diferencial Trifásico **Tipo B**

Disjuntor Tetrapolar  
Contactor Modular  
Botoneira Emergência com Chave

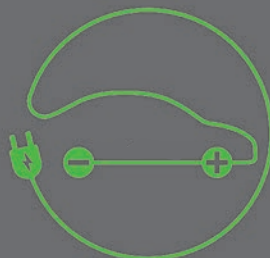

Adequado para Wall Box Trifásica até 22KW

Código	P.U.€
Codigo: QE-QMET-01-32A	440,00€

## Quadro Mobilidade Elétrica Trifásico, 32A(22KW) Com Contador Energia

Constituído por:

### Interruptor Diferencial Trifásico **Tipo B**

Contador Energia Modular Trifásico Modbus RS 485  
Disjuntor Tetrapolar  
Contactor Modular  
Botoneira Emergência com Chave

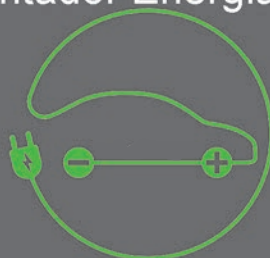

Adequado para Wall Box Trifásica até 22KW

Código	P.U.€
Codigo: QE-QMET-02-32A	530,00€

## Quadro Sondas Monofásico para 1 Bomba

Com Proteção Através de Relé Térmico e Disjuntor

Contactora e Relé Térmico **soflight**®

Relé Nivel Para Proteção da Bomba em Caso de Falta Água **AVEL**

Funcionamento Automático/Desligado. comandado por um comutador 2 Posições

Proteção contra Curto-Circuitos Através de Disjuntor

Proteção contra Sobrecargas através de Relé Térmico

Indicação Motor Ligado ( Sinalizador Verde )

Indicação Disparo Térmico ( Sinalizador Vermelho )



Código	Monofásico	Potência		Intensidade Amperes	Relé Térmico Regulação	Contactora Tripolar	Nº Polos	Disjuntor 4,5kA Amp.	P.U.€
		HP	KW						
QE-QSM-0254	Com Relé Térmico 2,5-4A - 230Vac	0,33-0,50	0,25-0,37	2,8-3,5	2,5-4A	12A	2	6-10	77,00€
QE-QSM-0406	Com Relé Térmico 4-6A - 230Vac	0,75-1	0,55-0,74	4,5-5,7	4-6A	12A	2	10-16	77,00€
QE-QSM-0558	Com Relé Térmico 5,5-8A - 230Vac	0,75-1	0,55-0,74	4,5-5,7	5,5-8A	12A	2	10-16	77,00€
QE-QSM-0710	Com Relé Térmico 7-10A - 230Vac	1,5	1-1,0	8,7	7-10A	12A	2	20	77,00€
QE-QSM-0913	Com Relé Térmico 9-13A - 230Vac	2	1,50	10,7	9-13A	18A	2	25	77,00€
QE-QSM-1218	Com Relé Térmico 12-18A - 230Vac	3	2,20	14,7	12-18A	18A	2	32	77,00€

## Quadro Sondas Trifásico para 1 Bomba

Com Proteção Através de Relé Térmico e Disjuntor

Contactora e Relé Térmico **soflight**®

Relé Nivel Para Proteção da Bomba em Caso de Falta Água **AVEL**

Funcionamento Automático/Desligado. comandado por um comutador 2 Posições

Proteção contra Curto-Circuitos Através de Disjuntor

Proteção contra Sobrecargas através de Relé Térmico

Indicação Motor Ligado ( Sinalizador Verde )

Indicação Disparo Térmico ( Sinalizador Vermelho )



Código	Trifásico	Potência		Intensidade Amperes	Relé Térmico Regulação	Contactora Tripolar	Nº Polos	Disjuntor 4,5kA Amp.	P.U.€
		HP	KW						
QE-QST-0116	Com Relé Térmico 1-1,6A - 400Vac	0,50	0,37	1,1	1-1,6A	12A	3	6	85,00€
QE-QST-01625	Com Relé Térmico 1,6-2,5A - 400Vac	0,75	0,55	1,6	1,6-2,5A	12A	3	6	85,00€
QE-QST-0254	Com Relé Térmico 2,5-4A - 400Vac	1	0,75	2,1	2,5-4A	12A	3	6	85,00€
QE-QST-0406	Com Relé Térmico 4-6A - 400Vac	1,5-2	1,1-1,5	3-3,9	4-6A	12A	3	6-10	85,00€
QE-QST-0558	Com Relé Térmico 5,5-8A - 400Vac	3	2,20	5,8	5,5-8A	12A	3	16	85,00€
QE-QST-0710	Com Relé Térmico 7-10A - 400Vac	4-5	3-3,7	7,5-6	7-10A	12A	3	16-20	85,00€
QE-QST-0913	Com Relé Térmico 9,13A - 400Vac	5,5	4	9,8	9-13A	18A	3	20	85,00€
QE-QST-1218	Com Relé Térmico 12-18A - 400Vac	7,5	5,6	13,5	12-18A	18A	3	32	85,00€



## Quadro Proteção Digital, SOFLIGHT-PRO com Relé **Toscano** TMP6

- \*Com proteção através de relé digital Toscano TMP6, Contacto e disjuntor 4,5kA
- \*Controlador digital TMP6 com interface intuitivo
- \*Bi-Tensão 230/400Vac para Bombas Monofásicas e Trifásicas
- \*Proteções: Sobrecorrente e subcorrente / Falta de Fase / Frequência Excessiva de Arranques
- \*Control de Nível Mediante Sondas Condutivas ( 1 ou 2 sondas ) ou sem sondas (subcorrente)
- \*Saída para Nível Baixo ( 5A Máximo )
- \*Saída para Alarme ( 5a Máximo )
- \*Indicação do Numero de Arranques da Bomba e Numero de Horas de Funcionamento da Bomba
- \*Intensidade de corrente máxima de 12A sem contactor / 40A com contactor
- \*Ajuste Intensidade Máxima: AUTO/0,5... 40A ( Disparo em 7s )
- \*Ajuste Intensidade Mínima: OFF/3...240 minutos
- \*Indicações: Motor Ligado / Alarme / Nível Baixo, Intensidade Máxima / Mínima, Tempo de Rearme

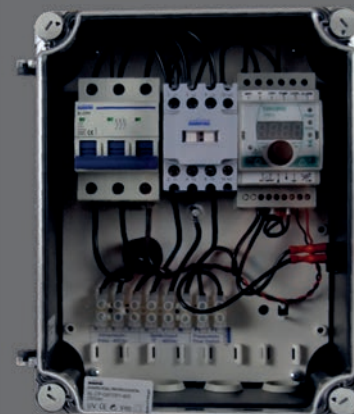

Código	Monofásico	HP	Potência KW	Intensidade Amperes	Contactor Tripolar	Disjuntor 4,5kA N° Polos Amp.	P.U.€
QE-QSMD01-230	Quadro Nivel Digital Monofásico SOFLIGHT PRO	0,33-3	0,25-2,2	2,8-14,7	18A	2 32	152,00€

Código	Trifásico	HP	Potência KW	Intensidade Amperes	Contactor Tripolar	Disjuntor 4,5kA N° Polos Amp.	P.U.€
QE-QSTD01-400	Quadro Nível Digital Trifásico SOFLIGHT PRO	0,5-7,5	0,37-5.6	1,1-13,5	18A	3 16	160,00€

## Quadro Proteção Digital com Relé **AVEL** PRObomba

- \*Com proteção através de relé digital **AVEL** e disjuntor 4,5kA
- \*Controlador digital com interface intuitivo que permite:
- \*Controlar/proteger bomba s/necessidade boia, através da medição de intensidade de corrente eléctrica
- \*Controlar/proteger bomba para enchimento de tanques através de ligação a boia nível
- \*Controlar e proteger motor eléctrico
- \*Intensidade de corrente máxima de 25A
- \*Determinação automática dos parâmetros de funcionamento da bomba/motor através do modo autotune ou introdução manual dos mesmos
- \*Desativação automática da bomba/motor em caso de sobrecorrente ( funcionamento anómalo bomba/motor) ou subcorrente (poço/furo sem água), com alerta no ecrã e com registo até 254 falhas
- \*Conhecimento em tempo real do estado da bomba/\*motor através do ecrã iluminado (Ligado / Desligado) intensidade de corrente eléctrica instantânea, tipo de falha (sobrecorrente, subcorrente) e contagem decrescente até nova tentativa após falha.
- \*Bloqueio automático do controlador após três falhas consecutivas de sobrecorrente, sendo o tempo de espera entre falhas 5 minutos, cinco falhas consecutivas de subcorrente, sendo o tempo de espera entre falhas configurável, permitindo adaptar este controlador a diferentes furos/poços de água.
- \*Versões para bombas / motores monofásicos (230Vac) e trifásicos (400Vac)

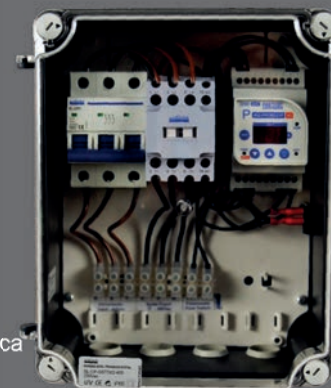

Código	Monofásico	HP	Potência KW	Intensidade Amperes	Contactor Tripolar	Disjuntor 4,5kA N° Polos Amp.	P. U.
QE-QSMD02-230	Quadro Digital Monofásico	0,33-3	0,25-2,2	2,8-14,7	18A	2 32	170,00€

Código	Trifásico	HP	Potência KW	Intensidade Amperes	Contactor Tripolar	Disjuntor 4,5kA N° Polos Amp.	P. U.
QE-QSTD02-400	Quadro Digital Trifásico	0,5-7,5	0,37-5.6	1,1-13,5	18A	3 16	185,00€

### Guarda Motor Sem Disjuntor para 1 Bomba Monofásico / Trifásico

Com Proteção Através de Relé Térmico sem Disjuntor  
 Contactor e Relé Térmico **soflight®**  
 Funcionamento Automático/Desligado comandado por um comutador 2 Posições  
 Proteção contra Sobrecargas através de Relé Térmico  
 Indicação Motor Ligado ( Sinalizador Verde )  
 Indicação Disparo Térmico ( Sinalizador Vermelho )

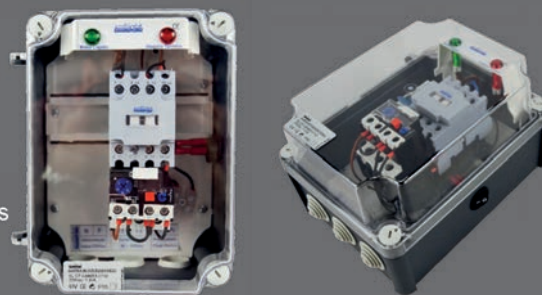

Código	Monofásico	Potência		Intensidade Amperes	Relé Térmico Regulação	Contactor Tripolar	P.U.€
		HP	KW				
QE-GMM01-0254	C/Relé Térmico 2,5-4A - 230Vac	0,33-0,50	0,25-0,37	2,8-3,5	2,5-4A	12A	39,50€
QE-GMM01-0406	C/Relé Térmico 4-6A - 230Vac	0,75-1	0,55-0,74	4,5-5,7	4-6A	12A	39,50€
QE-GMM01-0558	C/Relé Térmico 5,5-8A - 230Vac	0,75-1	0,55-0,74	4,5-5,7	5,5-8A	12A	39,50€
QE-GMM01-0710	C/Relé Térmico 7-10A - 230Vac	1,5	1-1,0	8,7	7-10A	12A	39,50€
QE-GMM01-0913	C/Relé Térmico 9-13A - 230Vac	2	1,50	10,7	9-13A	18A	39,50€
QE-GMM01-1218	C/Relé Térmico 12-18A - 230Vac	3	2,20	14,7	12-18A	18A	39,50€

Código	Trifásico	Potência		Intensidade Amperes	Relé Térmico Regulação	Contactor Tripolar	P.U.€
		HP	KW				
QE-GMT01-0116	C/Relé Térmico 1-1,6A - 400Vac	0,50	0,37	1,1	1-1,6A	12A	39,50€
QE-GMT01-01625	C/Relé Térmico 1,6-2,5A - 400Vac	0,75	0,55	1,6	1,6-2,5A	12A	39,50€
QE-GMT01-0254	C/Relé Térmico 2,5-4A - 400Vac	1	0,75	2,1	2,5-4A	12A	39,50€
QE-GMT01-0406	C/Relé Térmico 4-6A - 400Vac	1,5-2	1,1-1,5	3-3,9	4-6A	12A	39,50€
QE-GMT01-0558	C/Relé Térmico 5,5-8A - 400Vac	3	2,20	5,8	5,5-8A	12A	39,50€
QE-GMT01-0710	C/Relé Térmico 7-10A - 400Vac	4-5	3-3,7	7,5-6	7-10A	12A	39,50€
QE-GMT01-0913	C/Relé Térmico 9,13A - 400Vac	5,5	4	9,8	9-13A	18A	39,50€
QE-GMT01-1218	C/Relé Térmico 12-18A - 400Vac	7,5	5,6	13,5	12-18A	18A	39,50€

### Guarda Motor com Disjuntor para 1 Bomba Monofásico / Trifásico

Com Proteção Através de Relé Térmico e Disjuntor 4,5kA  
 Contactor e Relé Térmico **soflight®**  
 Funcionamento Automático/Desligado comandado por um comutador 2 Posições  
 Proteção contra Curto-Circuitos Através de Disjuntor  
 Proteção contra Sobrecargas através de Relé Térmico  
 Indicação Motor Ligado ( Sinalizador Verde )  
 Indicação Disparo Térmico ( Sinalizador Vermelho )



Código	Monofásico	Potência		Intensidade Amperes	Relé Térmico Regulação	Contactor Tripolar	Disjuntor 4,5kA Amp.		P.U.€
		HP	KW				Nº Polos	Amp.	
QE-GMM02-0254	C/Relé Térmico 2,5-4A - 230Vac	0,33-0,50	0,25-0,37	2,8-3,5	2,5-4A	12A	2	6-10	49,00€
QE-GMM02-0406	C/Relé Térmico 4-6A - 230Vac	0,75-1	0,55-0,74	4,5-5,7	4-6A	12A	2	10-16	49,00€
QE-GMM02-0558	C/Relé Térmico 5,5-8A - 230Vac	0,75-1	0,55-0,74	4,5-5,7	5,5-8A	12A	2	10-16	49,00€
QE-GMM02-0710	C/Relé Térmico 7-10A - 230Vac	1,5	1-1,0	8,7	7-10A	12A	2	20	49,00€
QE-GMM02-0913	C/Relé Térmico 9-13A - 230Vac	2	1,50	10,7	9-13A	18A	2	25	49,00€
QE-GMM02-1218	C/Relé Térmico 12-18A - 230Vac	3	2,20	14,7	12-18A	18A	2	32	49,00€

Código	Trifásico	Potência		Intensidade Amperes	Relé Térmico Regulação	Contactor Tripolar	Disjuntor 4,5kA Amp.		P.U.€
		HP	KW				Nº Polos	Amp.	
QE-GMT02-0116	C/Relé Térmico 1-1,6A - 400Vac	0,50	0,37	1,1	1-1,6A	12A	3	6	52,00€
QE-GMT02-01625	C/Relé Térmico 1,6-2,5A - 400Vac	0,75	0,55	1,6	1,6-2,5A	12A	3	6	52,00€
QE-GMT02-0254	C/Relé Térmico 2,5-4A - 400Vac	1	0,75	2,1	2,5-4A	12A	3	6	52,00€
QE-GMT02-0406	C/Relé Térmico 4-6A - 400Vac	1,5-2	1,1-1,5	3-3,9	4-6A	12A	3	6-10	52,00€
QE-GMT02-0558	C/Relé Térmico 5,5-8A - 400Vac	3	2,20	5,8	5,5-8A	12A	3	16	52,00€
QE-GMT02-0710	C/Relé Térmico 7-10A - 400Vac	4-5	3-3,7	7,5-6	7-10A	12A	3	16-20	52,00€
QE-GMT02-0913	C/Relé Térmico 9,13A - 400Vac	5,5	4	9,8	9-13A	18A	3	20	52,00€
QE-GMT02-1218	C/Relé Térmico 12-18A - 400Vac	7,5	5,6	13,5	12-18A	18A	3	32	52,00€

## Quadro Alternância Monofásico para 2 Bombas, Esvaziamento

Com Proteção Através de Relé Térmico sem Disjuntor  
 Contactor, Disjuntor e Relé Térmico **soflight**®  
 Funcionamento Automático/Desligado comandado por um comutador 2 Posições  
 Proteção contra Sobrecargas através de Relé Térmico  
 Indicação Motor Ligado ( Sinalizador Verde )  
 Indicação Disparo Térmico ( Sinalizador Vermelho )

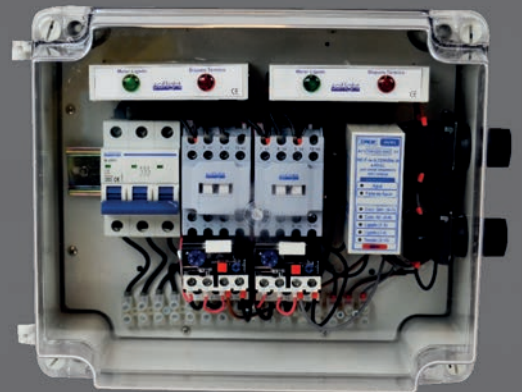

Código	Monofásico	HP	Potência KW	Intensidade Amperes	Relé Térmico Regulação	Contactor Tripolar	P.U.€
QE-QA2BM01-0116	C/Relé Térmico 1-1,6A - 230Vac	0,50	0,37	1,1	1-1,6A	12A	255,00€
QE-QA2BM01-01625	C/Relé Térmico 1,6-2,5A - 230Vac	0,75	0,55	1,6	1,6-2,5A	12A	255,00€
QE-QA2BM01-0254	C/Relé Térmico 2,5-4A - 230Vac	1	0,75	2,1	2,5-4A	12A	255,00€
QE-QA2BM01-0406	C/Relé Térmico 4-6A - 230Vac	1,5-2	1,1-1,5	3-3,9	4-6A	12A	255,00€
QE-QA2BM01-0558	C/Relé Térmico 5,5-8A - 230Vac	3	2,20	5,8	5,5-8A	12A	255,00€
QE-QA2BM01-0710	C/Relé Térmico 7-10A - 230Vac	4-5	3-3,7	7,5-6	7-10A	12A	255,00€
QE-QA2BM01-0913	C/Relé Térmico 9,13A - 230Vac	5,5	4	9,8	9-13A	18A	255,00€
QE-QA2BM01-1218	C/Relé Térmico 12-18A - 230Vac	7,5	5,6	13,5	12-18A	18A	255,00€

## Quadro Alternância Monofásico p/2 Bombas, Enchimento e Esvaziamento

Com Proteção Através de Relé Térmico sem Disjuntor  
 Contactor, Disjuntor e Relé Térmico **soflight**®  
 Enchimento e Esvaziamento  
 Funcionamento Automático/Desligado comandado por um comutador 2 Posições  
 Proteção contra Sobrecargas através de Relé Térmico  
 Indicação Motor Ligado ( Sinalizador Verde )  
 Indicação Disparo Térmico ( Sinalizador Vermelho )

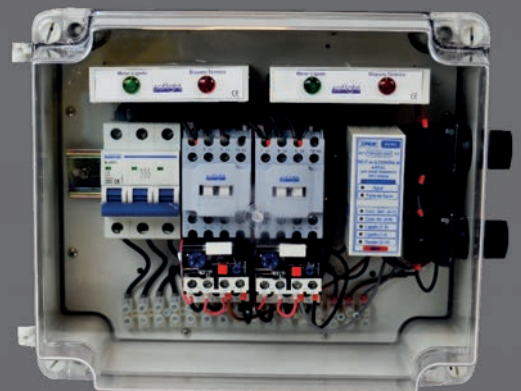

Código	Monofásico	HP	Potência KW	Intensidade Amperes	Relé Térmico Regulação	Contactor Tripolar	P.U.€
QE-QAEE2BM02-0116	C/Relé Térmico 1-1,6A - 230Vac	0,50	0,37	1,1	1-1,6A	12A	290,00€
QE-QAEE2BM02-01625	C/Relé Térmico 1,6-2,5A - 230Vac	0,75	0,55	1,6	1,6-2,5A	12A	290,00€
QE-QAEE2BM02-0254	C/Relé Térmico 2,5-4A - 230Vac	1	0,75	2,1	2,5-4A	12A	290,00€
QE-QAEE2BM02-0406	C/Relé Térmico 4-6A - 230Vac	1,5-2	1,1-1,5	3-3,9	4-6A	12A	290,00€
QE-QAEE2BM02-0558	C/Relé Térmico 5,5-8A - 230Vac	3	2,20	5,8	5,5-8A	12A	290,00€
QE-QAEE2BM02-0710	C/Relé Térmico 7-10A - 230Vac	4-5	3-3,7	7,5-6	7-10A	12A	290,00€
QE-QAEE2BM02-0913	C/Relé Térmico 9,13A - 230Vac	5,5	4	9,8	9-13A	18A	290,00€
QE-QAEE2BM02-1218	C/Relé Térmico 12-18A - 230Vac	7,5	5,6	13,5	12-18A	18A	290,00€

## Quadro Alternância Trifásico para 2 Bombas, Esvaziamento

Com Proteção Através de Relé Térmico sem Disjuntor

Contactor e Relé Térmico **soflight**®

Funcionamento Automático/Desligado comandado por um comutador 2 Posições

Proteção contra Sobrecargas através de Relé Térmico

Indicação Motor Ligado ( Sinalizador Verde )

Indicação Disparo Térmico ( Sinalizador Vermelho )

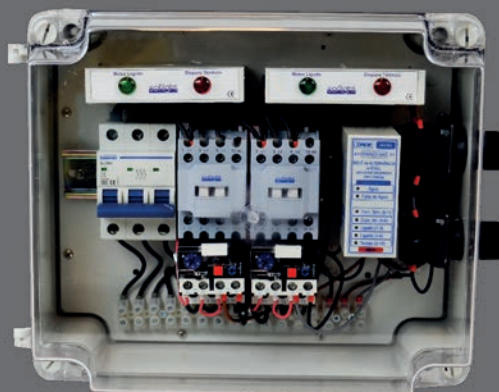

Código	Trifásico	HP	Potência KW	Intensidade Amperes	Relé Térmico Regulação	Contactor Tripolar	P.U.€
QE-QA2BT01-0116	C/Relé Térmico 1-1,6A - 400Vac	0,50	0,37	1,1	1-1,6A	12A	262,00€
QE-QA2BT01-01625	C/Relé Térmico 1,6-2,5A - 400Vac	0,75	0,55	1,6	1,6-2,5A	12A	262,00€
QE-QA2BT01-0254	C/Relé Térmico 2,5-4A - 400Vac	1	0,75	2,1	2,5-4A	12A	262,00€
QE-QA2BT01-0406	C/Relé Térmico 4-6A - 400Vac	1,5-2	1,1-1,5	3-3,9	4-6A	12A	262,00€
QE-QA2BT01-0558	C/Relé Térmico 5,5-8A - 400Vac	3	2,20	5,8	5,5-8A	12A	262,00€
QE-QA2BT01-0710	C/Relé Térmico 7-10A - 400Vac	4-5	3-3,7	7,5-6	7-10A	12A	262,00€
QE-QA2BT01-0913	C/Relé Térmico 9,13A - 400Vac	5,5	4	9,8	9-13A	18A	262,00€
QE-QA2BT01-1218	C/Relé Térmico 12-18A - 400Vac	7,5	5,6	13,5	12-18A	18A	262,00€

## Quadro Alternância Trifásico p/2 Bombas, Enchimento e Esvaziamento

Com Proteção Através de Relé Térmico sem Disjuntor

Contactor, Disjuntor e Relé Térmico **soflight**®

Enchimento e Esvaziamento

Funcionamento Automático/Desligado comandado por um comutador 2 Posições

Proteção contra Sobrecargas através de Relé Térmico

Indicação Motor Ligado ( Sinalizador Verde )

Indicação Disparo Térmico ( Sinalizador Vermelho )

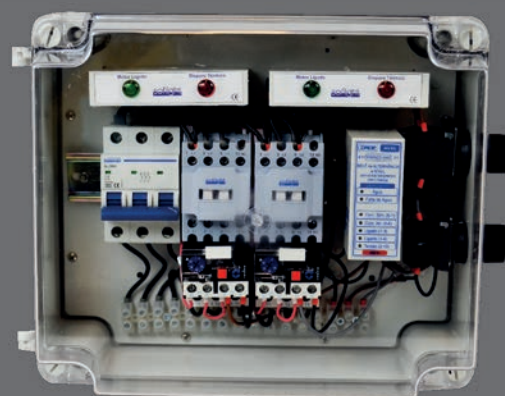

Código	Trifásico	HP	Potência KW	Intensidade Amperes	Relé Térmico Regulação	Contactor Tripolar	P.U.€
QE-QAEE2BT02-0116	C/Relé Térmico 1-1,6A - 400Vac	0,50	0,37	1,1	1-1,6A	12A	298,00€
QE-QAEE2BT02-01625	C/Relé Térmico 1,6-2,5A - 400Vac	0,75	0,55	1,6	1,6-2,5A	12A	298,00€
QE-QAEE2BT02-0254	C/Relé Térmico 2,5-4A - 400Vac	1	0,75	2,1	2,5-4A	12A	298,00€
QE-QAEE2BT02-0406	C/Relé Térmico 4-6A - 400Vac	1,5-2	1,1-1,5	3-3,9	4-6A	12A	298,00€
QE-QAEE2BT02-0558	C/Relé Térmico 5,5-8A - 400Vac	3	2,20	5,8	5,5-8A	12A	298,00€
QE-QAEE2BT02-0710	C/Relé Térmico 7-10A - 400Vac	4-5	3-3,7	7,5-6	7-10A	12A	298,00€
QE-QAEE2BT02-0913	C/Relé Térmico 9,13A - 400Vac	5,5	4	9,8	9-13A	18A	298,00€
QE-QAEE2BT02-1218	C/Relé Térmico 12-18A - 400Vac	7,5	5,6	13,5	12-18A	18A	298,00€

## Quadro Alternância Monofásico para 3 Bombas

Com Proteção Através de Relé Térmico sem Disjuntor

Contactor e Relé Térmico [soflight](#)

Funcionamento Automático/Desligado comandado por um comutador 2 Posições

Proteção contra Sobrecargas através de Relé Térmico

Indicação Motor Ligado ( Sinalizador Verde )

Indicação Disparo Térmico ( Sinalizador Vermelho )



Código	Monofásico	HP	Potência KW	Intensidade Amperes	Relé Térmico Regulação	Contactor Tripolar	P.U.€
QE-QA3BM01-0116	C/Relé Térmico 1-1,6A - 230Vac	0,50	0,37	1,1	1-1,6A	12A	330,00€
QE-QA3BM01-01625	C/Relé Térmico 1,6-2,5A - 230Vac	0,75	0,55	1,6	1,6-2,5A	12A	330,00€
QE-QA3BM01-0254	C/Relé Térmico 2,5-4A - 230Vac	1	0,75	2,1	2,5-4A	12A	330,00€
QE-QA3BM01-0406	C/Relé Térmico 4-6A - 230Vac	1,5-2	1,1-1,5	3-3,9	4-6A	12A	330,00€
QE-QA3BM01-0558	C/Relé Térmico 5,5-8A - 230Vac	3	2,20	5,8	5,5-8A	12A	330,00€
QE-QA3BM01-0710	C/Relé Térmico 7-10A - 230Vac	4-5	3-3,7	7,5-6	7-10A	12A	330,00€
QE-QA3BM01-0913	C/Relé Térmico 9,13A - 230Vac	5,5	4	9,8	9-13A	18A	330,00€
QE-QA3BM01-1218	C/Relé Térmico 12-18A - 230Vac	7,5	5,6	13,5	12-18A	18A	330,00€

## Quadro Alternância Monofásico para 3 Bombas

Com Proteção Através de Relé Térmico sem Disjuntor

Contactor e Relé Térmico [soflight](#)

Funcionamento Automático/Desligado comandado por um comutador 2 Posições

Proteção contra Sobrecargas através de Relé Térmico

Indicação Motor Ligado ( Sinalizador Verde )

Indicação Disparo Térmico ( Sinalizador Vermelho )



Código	Monofásico	HP	Potência KW	Intensidade Amperes	Relé Térmico Regulação	Contactor Tripolar	P.U.€
QE-QA3BM02-0116	C/Relé Térmico 1-1,6A - 230Vac	0,50	0,37	1,1	1-1,6A	12A	360,00€
QE-QA3BM02-01625	C/Relé Térmico 1,6-2,5A - 230Vac	0,75	0,55	1,6	1,6-2,5A	12A	360,00€
QE-QA3BM02-0254	C/Relé Térmico 2,5-4A - 230Vac	1	0,75	2,1	2,5-4A	12A	360,00€
QE-QA3BM02-0406	C/Relé Térmico 4-6A - 230Vac	1,5-2	1,1-1,5	3-3,9	4-6A	12A	360,00€
QE-QA3BM02-0558	C/Relé Térmico 5,5-8A - 230Vac	3	2,20	5,8	5,5-8A	12A	360,00€
QE-QA3BM02-0710	C/Relé Térmico 7-10A - 230Vac	4-5	3-3,7	7,5-6	7-10A	12A	360,00€
QE-QA3BM02-0913	C/Relé Térmico 9,13A - 230Vac	5,5	4	9,8	9-13A	18A	360,00€
QE-QA3BM02-1218	C/Relé Térmico 12-18A - 230Vac	7,5	5,6	13,5	12-18A	18A	360,00€

## Quadro Alternância Trifásico para 3 Bombas

Com Proteção Através de Relé Térmico sem Disjuntor

Contactora e Relé Térmico **soflight**®

Funcionamento Automático/Desligado comandado por um comutador 2 Posições

Proteção contra Sobrecargas através de Relé Térmico

Indicação Motor Ligado ( Sinalizador Verde )

Indicação Disparo Térmico ( Sinalizador Vermelho )



Código	Trifásico	HP	Potência KW	Intensidade Amperes	Relé Térmico Regulação	Contactora Tripolar	P.U.€	
QE-QA3BT01-0116	C/Relé Térmico	1-1,6A - 400Vac	0,50	0,37	1,1	1-1,6A	12A	390,00€
QE-QA3BT01-01625	C/Relé Térmico	1,6-2,5A - 400Vac	0,75	0,55	1,6	1,6-2,5A	12A	390,00€
QE-QA3BT01-0254	C/Relé Térmico	2,5-4A - 400Vac	1	0,75	2,1	2,5-4A	12A	390,00€
QE-QA3BT01-0406	C/Relé Térmico	4-6A - 400Vac	1,5-2	1,1-1,5	3-3,9	4-6A	12A	390,00€
QE-QA3BT01-0558	C/Relé Térmico	5,5-8A - 400Vac	3	2,20	5,8	5,5-8A	12A	390,00€
QE-QA3BT01-0710	C/Relé Térmico	7-10A - 400Vac	4-5	3-3,7	7,5-6	7-10A	12A	390,00€
QE-QA3BT01-0913	C/Relé Térmico	9,13A - 400Vac	5,5	4	9,8	9-13A	18A	390,00€
QE-QA3BT01-1218	C/Relé Térmico	12-18A - 400Vac	7,5	5,6	13,5	12-18A	18A	390,00€

## Quadro Alternância Trifásico para 3 Bombas

Com Proteção Através de Relé Térmico sem Disjuntor

Contactora e Relé Térmico **soflight**®

Funcionamento Automático/Desligado comandado por um comutador 2 Posições

Proteção contra Sobrecargas através de Relé Térmico

Indicação Motor Ligado ( Sinalizador Verde )

Indicação Disparo Térmico ( Sinalizador Vermelho )



Código	Trifásico	HP	Potência KW	Intensidade Amperes	Relé Térmico Regulação	Contactora Tripolar	P.U.€	
QE-QA3BT02-0116	C/Relé Térmico	1-1,6A - 400Vac	0,50	0,37	1,1	1-1,6A	12A	399,90€
QE-QA3BT02-01625	C/Relé Térmico	1,6-2,5A - 400Vac	0,75	0,55	1,6	1,6-2,5A	12A	399,90€
QE-QA3BT02-0254	C/Relé Térmico	2,5-4A - 400Vac	1	0,75	2,1	2,5-4A	12A	399,90€
QE-QA3BT02-0406	C/Relé Térmico	4-6A - 400Vac	1,5-2	1,1-1,5	3-3,9	4-6A	12A	399,90€
QE-QA3BT02-0558	C/Relé Térmico	5,5-8A - 400Vac	3	2,20	5,8	5,5-8A	12A	399,90€
QE-QA3BT02-0710	C/Relé Térmico	7-10A - 400Vac	4-5	3-3,7	7,5-6	7-10A	12A	399,90€
QE-QA3BT02-0913	C/Relé Térmico	9,13A - 400Vac	5,5	4	9,8	9-13A	18A	399,90€
QE-QA3BT02-1218	C/Relé Térmico	12-18A - 400Vac	7,5	5,6	13,5	12-18A	18A	399,90€

## Arrancador Estrela Triângulo

\* Montagem em Calha DIN sem Caixa

\* Inclui:

- 3 Contactores
- Relé Térmico
- Temporizador
- Borne de Ligação

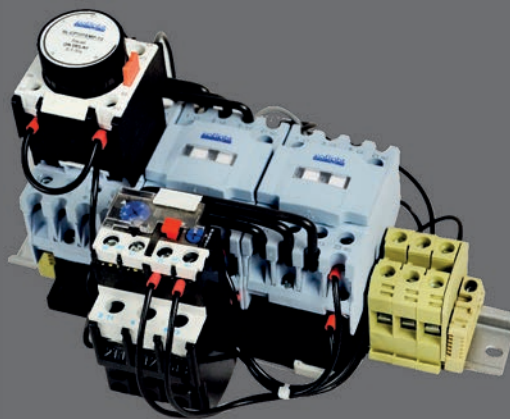

Código	Trifásico	KW	KW	KW	Relé Térmico Regulação	Contactora Tripolar	Contactora Tripolar	Contactora Tripolar	P.U.€
QE-AET01-0254	Arrancador Estrela Triângulo	22	22	22	2,5-4A	18A	18A	18A	215.00€
QE-AET01-0406	Arrancador Estrela Triângulo	22	22	22	4-6A	18A	18A	18A	215.00€
QE-AET01-0558	Arrancador Estrela Triângulo	22	22	22	5,5-8A	18A	18A	18A	215.00€
QE-AET01-0710	Arrancador Estrela Triângulo	22	22	22	7-10A	18A	18A	18A	215.00€
QE-AET01-0913	Arrancador Estrela Triângulo	22	22	22	9-13A	18A	18A	18A	215.00€
QE-AET01-1218	Arrancador Estrela Triângulo	30	30	30	12-18A	32A	32A	32A	280.00€
QE-AET01-1725	Arrancador Estrela Triângulo	30	30	30	17-25A	32A	32A	32A	280.00€
QE-AET01-2536	Arrancador Estrela Triângulo	75	75	75	25-36A	80A	80A	80A	750.00€
QE-AET01-3040	Arrancador Estrela Triângulo	75	75	75	30-40A	80A	80A	80A	750.00€
QE-AET01-3050	Arrancador Estrela Triângulo	147	147	147	30-50A	150A	150A	150A	3300.00€
QE-AET01-4880	Arrancador Estrela Triângulo	147	147	147	48-80A	150A	150A	150A	3300.00€
QE-AET01-63100	Arrancador Estrela Triângulo	147	147	147	63-100A	150A	150A	150A	3300.00€

## Arrancador Estrela Triângulo em Caixa

\* Montagem em Caixa

\* Inclui:

- 3 Contactores
- Relé Térmico
- Temporizador
- Borne de Ligação

Código	Trifásico	KW	KW	KW	Relé Térmico Regulação	Contactora Tripolar	Contactora Tripolar	Contactora Tripolar	P.U.€
QE-AET02-0254	Arrancador Estrela Triângulo	22	22	22	2,5-4A	18A	18A	18A	265.00€
QE-AET02-0406	Arrancador Estrela Triângulo	22	22	22	4-6A	18A	18A	18A	265.00€
QE-AET02-0558	Arrancador Estrela Triângulo	22	22	22	5,5-8A	18A	18A	18A	265.00€
QE-AET02-0710	Arrancador Estrela Triângulo	22	22	22	7-10A	18A	18A	18A	265.00€
QE-AET02-0913	Arrancador Estrela Triângulo	22	22	22	9-13A	18A	18A	18A	265.00€
QE-AET02-1218	Arrancador Estrela Triângulo	30	30	30	12-18A	32A	32A	32A	395.00€
QE-AET01-1725	Arrancador Estrela Triângulo	30	30	30	17-25A	32A	32A	32A	395.00€
QE-AET02-2536	Arrancador Estrela Triângulo	75	75	75	25-36A	80A	80A	80A	910.00€
QE-AET02-3040	Arrancador Estrela Triângulo	75	75	75	30-40A	80A	80A	80A	910.00€
QE-AET02-3050	Arrancador Estrela Triângulo	147	147	147	30-50A	150A	150A	150A	3700.00€
QE-AET02-4880	Arrancador Estrela Triângulo	147	147	147	48-80A	150A	150A	150A	3700.00€
QE-AET02-63100	Arrancador Estrela Triângulo	147	147	147	63-100A	150A	150A	150A	3700.00€

## Quadro de Piscina para 1 Bomba

- \* Quadro Elétrico protege a Eletrobomba termicamente através de 1 Interruptor Horário eletromecânico
- \* Possibilita a programação do tempo de funcionamento da eletrobomba
- \* Dispõe de 1 Disjuntor para ligar a eletrobomba manualmente
- \* Montagem em Quadro IP 65 para 12 Módulos com Tampa Transparente homologado segundo a norma IEC60439
- \* Inclui: Disjuntor Motor, Contactor Modular, Interruptor Diferencial Tipo AC 30mA Interruptor Horário, 1 a 2 Disjuntores unipolares para comando dos projectores



Código	Monofásico	HP	Potência KW	Intensidade Amperes	Relé Térmico Regulação	Contactora Tripolar	Disjuntor 4,5kA Nº Polos	Amp.	P.U.€
QE-QPM01-0254	C/Disjuntor Motor 2,5-4A - 230Vac	0,33-0,50	0,25-0,37	2,8-3,5	2,5-4A	12A	2	6-10	170,00€
QE-QPM01-0406	C/Disjuntor Motor 4-6A - 230Vac	0,75-1	0,55-0,74	4,5-5,7	4-6,3A	12A	2	10-16	170,00€
QE-QPM01-0610	C/Disjuntor Motor 6-10A - 230Vac	1,5	1,10	8,7	6-10A	12A	2	10-16	170,00€
QE-QPM01-0813	C/Disjuntor Motor 8-13A - 230Vac	2	1,50	10,7	9-14A	18A	2	25	170,00€
QE-QPM01-1318	C/Disjuntor Motor 13-18A - 230Vac	3	2,20	14,7	13-18A	18A	2	32	170,00€

Código	Trifásico	HP	Potência KW	Intensidade Amperes	Relé Térmico Regulação	Contactora Tripolar	Disjuntor 4,5kA Nº Polos	Amp.	P.U.€
QE-QPT01-0116	C/Disjuntor Motor 1-1,6A - 400Vac	0,50	0,37	1,1	1-1,6A	12A	3	6	200,00€
QE-QPT01-01625	C/Disjuntor Motor 1,6-2,5A - 400Vac	0,75	0,55	1,6	1,6-2,5A	12A	3	6	200,00€
QE-QPT01-0254	C/Disjuntor Motor 2,5-4A - 400Vac	1	0,75	2,1	2,5-4A	12A	3	6	200,00€
QE-QPT01-0406	C/Disjuntor Motor 4-6A - 400Vac	1,5-2	1,1-1,5	3-3,9	4-6,3A	12A	3	6-10	200,00€
QE-QPT01-0610	C/Disjuntor Motor 6-10A - 400Vac	4-5	3-3,7	7,5-9	6-10A	12A	3	20	200,00€
QE-QPT01-0813	C/Disjuntor Motor 8-13A - 400Vac	5,5	4	9,8	9-14A	18A	3	20	200,00€
QE-QPT01-13-18	C/Disjuntor Motor 13-18A - 400Vac	7,5	5,6	13,5	13-18A	18A	3	32	200,00€

## Quadro de Piscina para 1 Bomba (ECO)

- \* Quadro Elétrico protege a Eletrobomba termicamente através de 1 Interruptor Horário eletromecânico
- \* Possibilita a programação do tempo de funcionamento da eletrobomba
- \* Selector 3 Posições ( Manual / Desligado / Automático )
- \* Montagem em Caixa Estanque IP 65 com Tampa Transparente
- \* Inclui Contactor, Relé Térmico, Interruptor Horário, Disjuntor 4,5kA (FN/Monofásico - 3P Trifásico)



Código	Monofásico	HP	Potência KW	Intensidade Amperes	Relé Térmico Regulação	Contactora Tripolar	Disjuntor 4,5kA Nº Polos	Amp.	P.U.€
QE-QPM02-0254	C/Relé Térmico 2,5-4A - 230Vac	0,33-0,50	0,25-0,37	2,8-3,5	2,5-4A	12A	2	6-10	96,00€
QE-QPM02-0406	C/Relé Térmico 4-6A - 230Vac	0,75-1	0,55-0,74	4,5-5,7	4-6A	12A	2	10-16	96,00€
QE-QPM02-0558	C/Relé Térmico 5,5-8A - 230Vac	0,75-1	0,55-0,74	4,5-5,7	5,5-8A	12A	2	10-16	96,00€
QE-QPM02-0710	C/Relé Térmico 7-10A - 230Vac	1,5	1-1,0	8,7	7-10A	12A	2	20	96,00€
QE-QPM02-0913	C/Relé Térmico 9-13A - 230Vac	2	1,50	10,7	9-13A	18A	2	25	96,00€
QE-QPM02-1218	C/Relé Térmico 12-18A - 230Vac	3	2,20	14,7	12-18A	18A	2	32	96,00€

Código	Trifásico	HP	Potência KW	Intensidade Amperes	Relé Térmico Regulação	Contactora Tripolar	Disjuntor 4,5kA Nº Polos	Amp.	P.U.€
QE-QPT02-0116	C/Relé Térmico 1-1,6A - 400Vac	0,50	0,37	1,1	1-1,6A	12A	3	6	99,50€
QE-QPT02-01625	C/Relé Térmico 1,6-2,5A - 400Vac	0,75	0,55	1,6	1,6-2,5A	12A	3	6	99,50€
QE-QPT02-0254	C/Relé Térmico 2,5-4A - 400Vac	1	0,75	2,1	2,5-4A	12A	3	6	99,50€
QE-QPT02-0406	C/Relé Térmico 4-6A - 400Vac	1,5-2	1,1-1,5	3-3,9	4-6A	12A	3	6-10	99,50€
QE-QPT02-0558	C/Relé Térmico 5,5-8A - 400Vac	3	2,20	5,8	5,5-8A	12A	3	16	99,50€
QE-QPT02-0710	C/Relé Térmico 7-10A - 400Vac	4-5	3-3,7	7,5-6	7-10A	12A	3	16-20	99,50€
QE-QPT02-0913	C/Relé Térmico 9,13A - 400Vac	5,5	4	9,8	9-13A	18A	3	20	99,50€
QE-QPT02-1218	C/Relé Térmico 12-18A - 400Vac	7,5	5,6	13,5	12-18A	18A	3	32	99,50€



## Quadro de Piscina para 1 Bomba com Programação Bluetooth™

\* Montagem em Quadro IP 65 para 12 Módulos com Tampa Transparente

\* Inclui:

- Disjuntor Motor Ajustado á Amperagem da Bomba
- Interruptor Diferencial Tipo AC 30mA
- Disjuntor Unipolar 16A
- Contactor Modular 25A
- 2 Botões Pressão (Ligar e desligar Manualmente a Bomba e Iluminação)
- Relé **Toscano** TPM Poll-B que possibilita:
  - \* Programação 1 ou 2 Vezes por dia funcionamento da electrobomba
  - \* Programação 1 Vez por dia funcionamento Iluminação
  - \* Programação 1 Vez por dia funcionamento Iluminação RGB
  - \* Programação do Relé TPM Poll-B por Bluetooth

-Homologado segundo a norma IEC60439



Código	Monofásico	HP	Potência KW	Intensidade Amperes	Relé Térmico Regulação	Contactor Tripolar	Disjuntor 4,5kA Nº Polos Amp.	P.U.€
QE-QPM03-0254	C/Disjuntor Motor 2,5-4A - 230Vac	0,33-0,50	0,25-0,37	2,8-3,5	2,5-4A	12A	2 6-10	448.00€
QE-QPM03-0406	C/Disjuntor Motor 4-6A - 230Vac	0,75-1	0,55-0,74	4,5-5,7	4-6,3A	12A	2 10-16	448.00€
QE-QPM03-0610	C/Disjuntor Motor 6-10A - 230Vac	1,5	1,10	8,7	6-10A	12A	2 10-16	448.00€
QE-QPM03-0914	C/Disjuntor Motor 9-14A - 230Vac	2	1,50	10,7	9-14A	18A	2 25	448.00€
QE-QPM03-1318	C/Disjuntor Motor 13-18A - 230Vac	3	2,20	14,7	13-18A	18A	2 32	448.00€

Código	Trifásico	HP	Potência KW	Intensidade Amperes	Relé Térmico Regulação	Contactor Tripolar	Disjuntor 4,5kA Nº Polos Amp.	P.U.€
QE-QPT03-0116	C/Disjuntor Motor 1-1,6A - 400Vac	0,50	0,37	1,1	1-1,6A	12A	3 6	505.00€
QE-QPT03-01625	C/Disjuntor Motor 1,6-2,5A - 400Vac	0,75	0,55	1,6	1,6-2,5A	12A	3 6	505.00€
QE-QPT03-0254	C/Disjuntor Motor 2,5-4A - 400Vac	1	0,75	2,1	2,5-4A	12A	3 6	505.00€
QE-QPT03-0406	C/Disjuntor Motor 4-6A - 400Vac	1,5-2	1,1-1,5	3-3,9	4-6,3A	12A	3 6-10	505.00€
QE-QPT03-0610	C/Disjuntor Motor 6-10A - 400Vac	4-5	3-3,7	7,5-9	6-10A	12A	3 20	505.00€
QE-QPT03-0914	C/Disjuntor Motor 9-14A - 400Vac	5,5	4	9,8	9-14A	18A	3 20	505.00€
QE-QPT03-1318	C/Disjuntor Motor 13-18A - 400Vac	7,5	5,6	13,5	13-18A	18A	3 32	505.00€

## Quadro de Piscina para 1 Bomba

\* Montagem em Quadro IP 65 para 12 Módulos com Tampa Transparente

\* Inclui:

- Disjuntor Motor Ajustado á Amperagem da Bomba
- Interruptor Diferencial Tipo AC 30mA
- Disjuntor Unipolar 16A
- Contactor Modular 25A
- 2 Botões Pressão (Ligar e desligar Manualmente a Bomba e Iluminação)
- Relé **Toscano** TPM Poll que possibilita:
  - \* Programação 1 ou 2 Vezes por dia funcionamento da electrobomba
  - \* Programação 1 Vez por dia funcionamento Iluminação
  - \* Programação 1 Vez por dia funcionamento Iluminação RGB

-Homologado segundo a norma IEC60439



Código	Monofásico	HP	Potência KW	Intensidade Amperes	Relé Térmico Regulação	Contactor Tripolar	Disjuntor 4,5kA Nº Polos Amp.	P.U.€
QE-QPM04-0254	C/Disjuntor Motor 2,5-4A - 230Vac	0,33-0,50	0,25-0,37	2,8-3,5	2,5-4A	12A	2 6-10	348.00€
QE-QPM04-0406	C/Disjuntor Motor 4-6A - 230Vac	0,75-1	0,55-0,74	4,5-5,7	4-6,3A	12A	2 10-16	348.00€
QE-QPM04-0610	C/Disjuntor Motor 6-10A - 230Vac	1,5	1,10	8,7	6-10A	12A	2 10-16	348.00€
QE-QPM04-0914	C/Disjuntor Motor 9-14A - 230Vac	2	1,50	10,7	9-14A	18A	2 25	348.00€
QE-QPM04-1318	C/Disjuntor Motor 13-18A - 230Vac	3	2,20	14,7	13-18A	18A	2 32	348.00€

Código	Trifásico	HP	Potência KW	Intensidade Amperes	Relé Térmico Regulação	Contactor Tripolar	Disjuntor 4,5kA Nº Polos Amp.	P.U.€
QE-QPT04-0116	C/Disjuntor Motor 1-1,6A - 400Vac	0,50	0,37	1,1	1-1,6A	12A	3 6	400.00€
QE-QPT04-01625	C/Disjuntor Motor 1,6-2,5A - 400Vac	0,75	0,55	1,6	1,6-2,5A	12A	3 6	400.00€
QE-QPT04-0254	C/Disjuntor Motor 2,5-4A - 400Vac	1	0,75	2,1	2,5-4A	12A	3 6	400.00€
QE-QPT04-0406	C/Disjuntor Motor 4-6A - 400Vac	1,5-2	1,1-1,5	3-3,9	4-6,3A	12A	3 6-10	400.00€
QE-QPT04-0610	C/Disjuntor Motor 6-10A - 400Vac	4-5	3-3,7	7,5-9	6-10A	12A	3 20	400.00€
QE-QPT04-0914	C/Disjuntor Motor 9-14A - 400Vac	5,5	4	9,8	9-14A	18A	3 20	400.00€
QE-QPT04-1318	C/Disjuntor Motor 13-18A - 400Vac	7,5	5,6	13,5	13-18A	18A	3 32	400.00€



### Quadros ABS c/Platine Metálica

Temperatura de trabalho: -40° C / + 80° C

RAL : 7035

650° C Glow Wire (Stand)

960° C Glow Wire (HF tipo)

Parafusos em Inox

Resistência Impacto

Platine Metálica Incluída



### Chassi para Quadros em ABS

Código	Altura	Largura	Profund.	Q/P	NºMod.	P.U.€
SL-08-CH300X400	300mm	200mm	130mm	ABS	2x12	22,50€
SL-08-CH400X500	400mm	500mm	190mm	ABS	3x15	27,50€
SL-08-CH400X600	400mm	600mm	200mm	ABS	4x15	31,80€

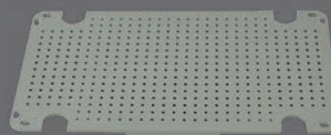

### Platine Plástico p/Quadros ABS

Código	Altura	Largura	Espes.	Q/P	P.U.€
SL-08-PLA400300	400mm	300mm	2,5mm	ABS	3,10€
SL-08-PLA500400	500mm	400mm	2,5mm	ABS	4,00€
SL-08-PLA600400	600mm	400mm	2,5mm	ABS	8,25€

Código	Altura	Largura	Profund.	Platina	P.U.€
SL-08-200300130	300mm	200mm	130mm	1,5mm	44,20€
SL-08-300400170	400mm	300mm	170mm	1,5mm	60,50€
SL-08-300400220	400mm	300mm	220mm	1,5mm	75,60€
SL-08-400500180	500mm	400mm	180mm	1,5mm	78,30€
SL-08-400500240	500mm	400mm	240mm	1,5mm	105,50€
SL-08-400600200	600mm	400mm	200mm	1,5mm	115,00€
SL-08-500700250	700mm	500mm	250mm	1,5mm	185,00€
SL-08-600800260	800mm	600mm	260mm	1,5mm	275,00€



### Grelha com Filtro para Quadros Porta Documentos

Código	Altura	Largura	Q/P	P.U.€
SL-08-GRE105	105mm	105mm	ABS	5,60€
SL-08-GRE150	150mm	150mm	ABS	7,90€
SL-08-GRE250	250mm	250mm	ABS	15,50€

Código	Altura	Largura	Q/P	P.U.€
SL-08-PDA4	230mm	218mm	A4	8,30€
SL-08-PDA5	175mm	206mm	A5	6,90€

### Caixa em ABS

RAL 7035

Produzidas em ABS

Temp. Trabalho: -40°C a 80°C

Fornecida sem platina

IP 65

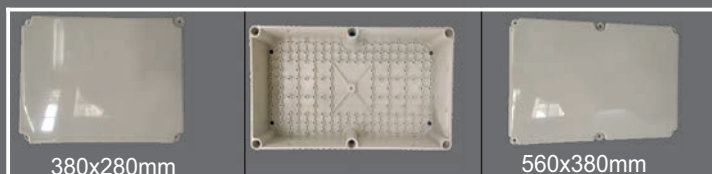

Código	Comp.	Largura	Altura	Mat.	P.U.€
SL-CX-ABS382818-CZ	380mm	280mm	180mm	ABS	80,00€
SL-CX-ABS382823-CZ	380mm	280mm	230mm	ABS	95,00€
SL-CX-ABS563818-CZ	560mm	380mm	180mm	ABS	155,00€

Código	Comp.	Largura	Mat.	P.U.€
SL-CX-ABS-PL3828-P	380mm	280mm	ABS	12,50€



Platina para CX 380x280, para CX 560x380 usar 2 Platinas

Quadro Metálico com Porta 1,2mm  
Platina Metálica Incluída 2mm  
RAL 7035, IP 66  
Alta Resistência a Impactos, IK 10  
Resistência em Ambientes Corrosivos  
IEC60529, EN61000-6-1, EN61000-6-3



Novos  
Podutos

Código	Altura	Largura	Profund.	Q/P	Platina	P.U.€
SL-QMP25.20.15	250mm	200mm	150mm	1,2mm	1,5mm	50,20€
SL-QMP30.25.15	300mm	250mm	150mm	1,2mm	1,5mm	60,40€
SL-QMP40.30.15	400mm	300mm	150mm	1,2mm	1,5mm	82,25€
SL-QMP40.30.20	400mm	300mm	200mm	1,2mm	1,5mm	86,10€
SL-QMP40.40.15	400mm	400mm	150mm	1,2mm	1,5mm	96,00€
SL-QMP50.30.15	500mm	300mm	150mm	1,2mm	1,5mm	110,00€
SL-QMP50.40.15	500mm	400mm	150mm	1,2mm	1,5mm	114,80€
SL-QMP50.40.20	500mm	400mm	200mm	1,2mm	1,5mm	126,80€
SL-QMP50.40.25	500mm	400mm	250mm	1,2mm	1,5mm	128,00€
SL-QMP50.40.30	500mm	400mm	300mm	1,2mm	1,5mm	130,00€
SL-QMP60.40.15	600mm	400mm	150mm	1,2mm	1,5mm	136,60€
SL-QMP60.40.20	600mm	400mm	200mm	1,2mm	1,5mm	145,10€
SL-QMP60.40.25	600mm	400mm	250mm	1,2mm	1,5mm	147,00€
SL-QMP60.40.30	600mm	400mm	300mm	1,2mm	1,5mm	148,00€
SL-QMP60.50.25	600mm	500mm	250mm	1,2mm	1,5mm	170,00€
SL-QMP60.50.30	600mm	500mm	300mm	1,2mm	1,5mm	180,00€
SL-QMP60.60.25	600mm	600mm	250mm	1,2mm	1,5mm	195,00€
SL-QMP60.60.30	600mm	600mm	300mm	1,2mm	1,5mm	210,00€
SL-QMP70.50.20	700mm	500mm	200mm	1,2mm	1,5mm	205,60€
SL-QMP70.50.25	700mm	500mm	250mm	1,2mm	1,5mm	218,80€
SL-QMP70.50.30	700mm	500mm	300mm	1,2mm	1,5mm	222,00€
SL-QMP80.60.20	800mm	600mm	200mm	1,5mm	2,0mm	290,00€
SL-QMP80.60.25	800mm	600mm	250mm	1,5mm	2,0mm	308,50€
SL-QMP80.60.30	800mm	600mm	300mm	1,5mm	2,0mm	321,60€
SL-QMP80.60.40	800mm	600mm	400mm	1,5mm	2,0mm	330,00€
SL-QMP80.80.25	800mm	800mm	250mm	1,5mm	2,0mm	345,00€
SL-QMP80.80.30	800mm	800mm	300mm	1,5mm	2,0mm	350,00€
SL-QMP100.60.25	1000mm	600mm	250mm	1,5mm	2,0mm	380,00€
SL-QMP100.60.30	1000mm	600mm	300mm	1,5mm	2,0mm	385,00€
SL-QMP100.60.40	1000mm	600mm	400mm	1,5mm	2,0mm	390,00€
SL-QMP100.80.25	1000mm	800mm	250mm	1,5mm	2,0mm	430,00€
SL-QMP100.80.30	1000mm	800mm	300mm	1,5mm	2,0mm	435,00€
SL-QMP100.80.40	1000mm	800mm	400mm	1,5mm	2,0mm	460,00€
SL-QMP120.60.25	1200mm	600mm	250mm	1,5mm	2,0mm	440,00€
SL-QMP120.60.30	1200mm	600mm	300mm	1,5mm	2,0mm	455,00€
SL-QMP120.60.40	1200mm	600mm	400mm	1,5mm	2,0mm	465,00€
SL-QMP120.80.25	1200mm	800mm	250mm	1,5mm	2,0mm	470,00€
SL-QMP120.80.30	1200mm	800mm	300mm	1,5mm	2,0mm	485,00€
SL-QMP120.80.40	1200mm	800mm	400mm	1,5mm	2,0mm	497,00€
SL-QMP120.100.30	1200mm	1000mm	300mm	1,5mm	2,0mm	606,00€
SL-QMP120.100.40	1200mm	1000mm	400mm	1,5mm	2,0mm	656,00€
SL-QMP140.80.30	1400mm	800mm	300mm	1,5mm	2,0mm	525,00€
SL-QMP140.80.40	1400mm	800mm	400mm	1,5mm	2,0mm	560,00€
SL-QMP140.120.40	1400mm	1200mm	400mm	1,5mm	2,0mm	866,00€

Chassi Metálico para Quadros Metálicos  
200mm profundidade RAL 7035



Novos  
Podutos

Código	Altura	Largura	NºModulos	P.U.€
SL-CHM40.30	400mm	300mm	2 x 9=18	62,00€
SL-CHM50.40	500mm	400mm	3 X 15=45	76,00€
SL-CHM60.40	600mm	400mm	3 X 15=45	84,00€
SL-CHM70.50/3	700mm	500mm	3 X 21=63	108,00€
SL-CHM70.50/4	700mm	500mm	4 X 21=84	110,00€
SL-CHM80.60/3	800mm	600mm	3 X 26=78	140,00€
SL-CHM80.60/4	800mm	600mm	4 X 26=104	145,00€
SL-CHM100.60	1000mm	600mm	6 X 26=156	170,00€
SL-CHM100.80	1000mm	800mm	6 X 38=228	199,00€

Fechadura com Chave para  
Quadro Metálico



Novos  
Podutos

Código	Descrição	P.U.€
SL-QPL-FECHADURA	Fech.p/ Quadro Poliester	8,50€

Suporte Fixação Quadro ao Poste



Novos  
Podutos

Código	Descrição	P.U.€
SL-WA080	Suporte Fixação Quad.Metal. ao Poste	110,00€

Quadro em Inox 304 com Porta 1,2mm  
 Platina Metálica Incluída 2mm  
 Inox 304, IP 66  
 Alta Resistência a Impactos, IK 10  
 Resistência em Ambientes Corrosivos  
 IEC60529, EN61000-6-1, EN61000-6-3



Novos  
 Produtos

Código	Altura	Largura	Profund.	Q/P	Platina	P.U.€
SL-QIP25.20.15	250mm	200mm	150mm	1,2mm	1,5mm	295,00€
SL-QIP30.25.15	300mm	250mm	150mm	1,2mm	1,5mm	295,00€
SL-QIP40.30.15	400mm	300mm	150mm	1,2mm	1,5mm	370,00€
SL-QIP40.30.20	400mm	300mm	200mm	1,2mm	1,5mm	410,00€
SL-QIP50.40.20	500mm	400mm	200mm	1,2mm	1,5mm	550,00€
SL-QIP60.40.20	600mm	400mm	200mm	1,2mm	1,5mm	600,00€
SL-QIP70.50.25	700mm	500mm	250mm	1,2mm	1,5mm	860,00€
SL-QIP80.60.20	800mm	600mm	200mm	1,5mm	2,0mm	1240,00€
SL-QIP80.60.25	800mm	600mm	250mm	1,5mm	2,0mm	1300,00€
SL-QIP80.60.30	800mm	600mm	300mm	1,5mm	2,0mm	1340,00€
SL-QIP80.60.40	800mm	600mm	400mm	1,5mm	2,0mm	1365,00€
SL-QIP100.60.25	1000mm	600mm	250mm	1,5mm	2,0mm	1550,00€
SL-QIP100.80.25	1000mm	800mm	250mm	1,5mm	2,0mm	1850,00€
SL-QIP100.80.30	1000mm	800mm	300mm	1,5mm	2,0mm	1950,00€
SL-QIP120.80.30	1200mm	800mm	300mm	1,5mm	2,0mm	2300,00€
SL-QIP120.80.40	1200mm	800mm	400mm	1,5mm	2,0mm	2495,00€
SL-QIP140.80.40	1400mm	800mm	400mm	1,5mm	2,0mm	2995,00€

Mesa Comando com Porta 1,2mm  
 Platina Metálica Incluída 2mm  
 RAL 7035, IP 66  
 Alta Resistência a Impactos, IK 10  
 Resistência em Ambientes Corrosivos  
 IEC60529, EN61000-6-1, EN61000-6-3



Código	Altura	Largura	Profundidade	Platina	Nº Portas	P.U.€
SL-MC96.50.40	960mm	500mm	400mm	780x430mm	1	720,00€
SL-MC96.60.40	960mm	600mm	400mm	780x530mm	1	765,00€
SL-MC96.80.40	960mm	800mm	400mm	780x730mm	1	865,00€
SL-MC96.100.40	960mm	1000mm	400mm	780x930mm	2	970,00€
SL-MC96.120.40	960mm	1200mm	400mm	780x1130mm	2	1070,00€

# Quadros em Poliester

Quadro em Poliester com Porta Opaca  
IP 65

Alta Resistência a Impactos, IK 10  
Resistência em Ambientes Corrosivos  
IEC60529, EN61000-6-1, EN61000-6-3



Novos  
Podutos

Código	Altura	Largura	Profund.	P.U.€
SL-QPL30.25.14	300mm	250mm	140mm	53,50€
SL-QPL40.30.20	400mm	300mm	200mm	73,80€
SL-QPL40.40.20	400mm	400mm	200mm	97,50€
SL-QPL50.40.20	500mm	400mm	200mm	106,00€
SL-QPL60.40.23	600mm	400mm	230mm	131,00€
SL-QPL60.50.23	600mm	500mm	230mm	145,00€
SL-QPL80.60.30	800mm	600mm	300mm	220,00€

Quadro em Poliester c/Porta Transparente  
IP 65

Alta Resistência a Impactos, IK 10  
Resistência em Ambientes Corrosivos  
IEC60529, EN61000-6-1, EN61000-6-3



Novos  
Podutos

Código	Altura	Largura	Profund.	P.U.€
SL-QPL40.30.20PT	400mm	300mm	200mm	98,00€
SL-QPL40.40.20PT	400mm	400mm	200mm	110,00€
SL-QPL50.40.20PT	500mm	400mm	200mm	138,00€
SL-QPL60.40.23PT	600mm	400mm	230mm	158,00€
SL-QPL60.50.23PT	600mm	500mm	230mm	164,00€
SL-QPL80.60.30PT	800mm	600mm	300mm	305,00€

Platina Metálica p/ Quadro em Poliester

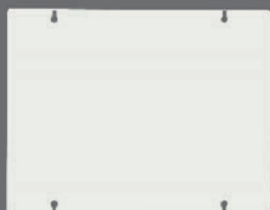

Novos  
Podutos

Código	Altura	Largura	Eppessura	P.U.€
SL-QPLPM.30.25	300mm	250mm	1,5mm	8,90€
SL-QPLPM.40.30	400mm	300mm	1,5mm	16,00€
SL-QPLPM.40.40	400mm	400mm	1,5mm	20,00€
SL-QPLPM.50.40	500mm	400mm	1,5mm	33,30€
SL-QPLPM.60.40	600mm	400mm	1,5mm	42,00€
SL-QPLPM.60.50	600mm	500mm	1,5mm	51,00€
SL-QPLPM.80.60	800mm	600mm	1,5mm	78,00€

Platina Poliester / Quadro em Poliester

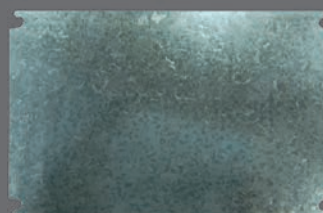

Novos  
Podutos

Código	Altura	Largura	Eppessura	P.U.€
SL-QPLPP.30.25	300mm	250mm	1,5mm	9,00€
SL-QPLPP.40.30	400mm	300mm	1,5mm	14,00€
SL-QPLPP.40.40	400mm	400mm	1,5mm	18,80€
SL-QPLPP.50.40	500mm	400mm	1,5mm	22,20€
SL-QPLPP.60.40	600mm	400mm	1,5mm	37,30€
SL-QPLPP.60.50	600mm	500mm	1,5mm	44,50€
SL-QPLPP.80.60	800mm	600mm	1,5mm	66,70€

Chassi para Quadro em Poliester



Novos  
Podutos

Código	Altura	Largura	Nº Módulos	P.U.€
SL-QPLCH.40.30	400mm	300mm	2x12=24	67,00€
SL-QPLCH.40.40	400mm	400mm	2x18=36	74,00€
SL-QPLCH.50.40	500mm	400mm	3x18=54	91,00€
SL-QPLCH.60.40	600mm	400mm	4x18=72	125,00€
SL-QPLCH.60.50	600mm	500mm	4x23=92	145,00€
SL-QPLCH.80.60	800mm	600mm	5x29=145	164,00€

Suporte Fixação Quadro ao Poste



Novos  
Podutos

Código	Descrição	P.U.€
SL-QPL-SUP-POSTE	Suporte Fix. Quadro ao Poste	110,00€

Fechadura C/ Chave p/Quadro Poliester



Novos  
Podutos

Código	Descrição	P.U.€
SL-QPL-FECHADURA	Fech.p/ Quadro Poliester	16,50€

### Armários Metálicos Configuráveis RAL 7035, IP 65



Novos  
Produtos

Armários Configuráveis	Perfil	Topo + Base	Porta Frontal + Painel Traseiro	Painéis Laterais	Platina Metálica	Base / Rodapé
Altura:1600mm Largura:600mm Profundidade.:400mm	SL-PER16 P.U.: 200,00€	SL-TB64 P.U.: 290,00€	SL-PFPT166 P.U.: 360,00€	SL-PL164 P.U.: 190,00€	SL-PM166 P.U.: 160,00€	SL-BA64.100 P.U.: 44,00€
Altura:1600mm Largura:600mm Profundidade.:600mm	SL-PER16 P.U.: 200,00€	SL-TB66 P.U.: 336,00€	SL-PFPT166 P.U.: 360,00€	SL-PL166 P.U.: 245,00€	SL-PM166 P.U.: 160,00€	SL-BA66.100 P.U.: 50,00€
Altura:1600mm Largura:800mm Profundidade.:400mm	SL-PER16 P.U.: 200,00€	SL-TB84 P.U.: 330,00€	SL-PFPT168 P.U.: 430,00€	SL-PL164 P.U.: 190,00€	SL-PM168 P.U.: 205,00€	SL-BA84.100 P.U.: 50,00€
Altura:1600mm Largura:800mm Profundidade.:600mm	SL-PER16 P.U.: 200,00€	SL-TB86 P.U.: 385,00€	SL-PFPT168 P.U.: 430,00€	SL-PL166 P.U.: 245,00€	SL-PM168 P.U.: 205,00€	SL-BA86.100 P.U.: 57,00€
Altura:2000mm Largura:600mm Profundidade:400mm	SL-PER20 P.U.: 245,00€	SL-TB64 P.U.: 290,00€	SL-PFPT206 P.U.: 425,00€	SL-PL204 P.U.: 215,00€	SL-PM206 P.U.: 195,00€	SL-BA64.100 P.U.: 44,00€
Altura:2000mm Largura:600mm Profundidade:600mm	SL-PER20 P.U.: 245,00€	SL-TB66 P.U.: 336,00€	SL-PFPT206 P.U.: 425,00€	SL-PL206 P.U.: 298,00€	SL-PM206 P.U.: 195,00€	SL-BA66.100 P.U.: 50,00€
Altura:2000mm Largura:800mm Profundidade:400mm	SL-PER20 P.U.: 245,00€	SL-TB84 P.U.: 330,00€	SL-PFPT208 P.U.: 520,00€	SL-PL204 P.U.: 185,00€	SL-PM208 P.U.: 250,00€	SL-BA84.100 P.U.: 50,00€
Altura:2000mm Largura:800mm Profundidade:600mm	SL-PER20 P.U.: 245,00€	SL-TB86 P.U.: 385,00€	SL-PFPT208 P.U.: 520,00€	SL-PL206 P.U.: 298,00€	SL-PM208 P.U.: 250,00€	SL-BA86.100 P.U.: 57,00€

## Acessórios para Chassi Modular



**SL-MDP-102F**

Placa 1x25 Modulos  
600x198mm  
RAL 7035  
Calha DIN Incluída  
P.U. 60.00€



**SL-MDP-202F**

Placa 1x36 Modulos  
800x198mm  
RAL 7035  
Calha DIN Incluída  
P.U. 69.00€



**SL-MDP-204F**

Placa 2x25 Modulos  
600x398mm  
RAL 7035  
Calha DIN Incluída  
P.U. 79.00€



**SL-MDP-204F**

Placa 2x36 Modulos  
800x398mm  
RAL 7035  
Calha DIN Incluída  
P.U. 94.00€



**SL-MDP-602**

Placa Cega  
600x200mm  
RAL 7035  
P.U. 43.00€



**SL-MDP-603**

Placa Cega  
600x300mm  
RAL 7035  
P.U. 53.00€



**SL-MDP-604**

Placa Cega  
600x400mm  
RAL 7035  
P.U. 62.00€

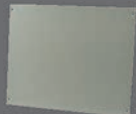

**SL-MDP-606**

Placa Cega  
600x600mm  
RAL 7035  
P.U. 73.00€



**SL-MDP-802**

Placa Cega  
800x200mm  
RAL 7035  
P.U. 50.00€



**SL-MDP-803**

Placa Cega  
800x300mm  
RAL 7035  
P.U. 63.00€



**SL-MDP804**

Placa Cega  
800x400mm  
RAL 7035  
P.U. 75.00€



**SL-MDP806**

Placa Cega  
800x600mm  
RAL 7035  
P.U. 100.00€



**SL-MDP-604F**

Placa Cega Emb.  
600x400mm  
RAL 7035  
P.U. 70.00€



**SL-MDP-606F**

Placa Cega Emb.  
600x600mm  
RAL 7035  
P.U. 92.00€



**SL-MDP-804F**

Placa Cega Emb.  
800x400mm  
RAL 7035  
P.U. 85.00€



**SL-MDP-806F**

Placa Cega Emb.  
800x600mm  
RAL 7035  
P.U. 115.00€



**SL-MP64**

Platina Metálica  
p/Arm. c/600mm  
592x333mm  
Galvanizada  
P.U. 139.00€



**SL-MP82**

Platina Metálica  
p/Arm. c/800mm  
692x133mm  
Galvanizada  
P.U. 112.00€



**SL-MDP604**

Platina Metálica  
p/Arm. c/800mm  
692x533mm  
Galvanizada  
P.U. 208.00€



**SL-WD400**

Perfil Horizontal  
( Kit 4 Peças )  
Galvanizado  
P.U. 77.00€



**SL-WD600**

Perfil Horizontal  
( Kit 4 Peças )  
Galvanizado  
P.U. 94.00€



**SL-H1600**

Perfil Vertical  
Kit 2 perfis  
1600mm  
Galvanizado  
P.U. 92.00€



**SL-H2000**

Perfil Vertical  
Kit 2 perfis  
2000mm  
Galvanizado  
P.U. 115.00€



**SL-HU1600**

Perfil Vertical  
Kit 4 perfis  
1600mm  
RAL 7035  
P.U. 225.00€



**SL-HU2000**

Perfil Vertical  
Kit 4 perfis  
2000mm  
RAL 7035  
P.U. 268.00€



**SL-HW1600**

Perfil Vertical  
Kit 4 perfis  
1600mm  
Galvanizado  
P.U. 230.00€



**SL-HW2000**

Perfil Vertical  
Kit 4 perfis  
2000mm  
Galvanizado  
P.U. 262.00€



**SL-WD470**

Perfil para  
Porta 600mm  
RAL 7035  
P.U. 20.00€



**SL-LP208.90**

Placa Ventilação  
208x90mm  
P.U. 13.00€



**SL-LP244.90**

Placa Ventilação  
244x90mm  
P.U. 14.00€



**SL-LP358-128**

Placa Ventilação  
358x128mm  
P.U. 18.00€



**SL-WA010**

Parafuso  
Prolongador  
Kit 6 pcs  
Galvanizado  
P.U. 20.00€



**SL-WA020**

Kit Acessórios  
4 Peças para  
União Quadros  
Galvanizado  
P.U. 30.00€



**SL-WA030**

Kit Acessórios  
Para União de  
Dois Quadros  
Galvanizado  
P.U. 7.20€



**SL-RUB10**

Rolo com 10 mts  
Junta para  
Armários Metálicos  
P.U. 15.00€



**SL-TSN-M6**

Inserção  
Para Perfil  
P.U. 2.50€



**SL-WA6**

Inserção  
Para Perfil  
P.U. 2.50€



**SL-SN-M6**

Inserção  
Para perfil  
Galvanizado  
P.U. 1.5€



**SL-PP600**

Suporte Metálico  
P/ Projectos  
455x260x90mm  
Cor: Laranja  
P.U. 56.00€

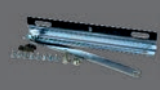

**SL-DS100**

Travamento  
Porta  
Galvanizado  
P.U. 12.00€



**SL-SUP.02**

Suporte para  
Calha DIN  
P.U. 2.50€



**SL-SUP.02.45**

Suporte para  
Calha DIN 45°  
P.U. 2.50€

### Bornes para Calha DIN, Push-in



**SL-BD1025PI-G**  
Borne Calha DIN  
Push-in-800V/31A  
0,2-2,5mm<sup>2</sup>  
Cor: Cinza  
Qt/Emb.50pcs  
**P.U. 0,700€**

**SL-BD1025PI-B**  
Borne Calha DIN  
Push-in-800V/31A  
0,2-2,5mm<sup>2</sup>  
Cor: Azul  
Qt/Emb.50pcs  
**P.U. 0,700€**

**SL-BD1025PI-PE**  
Borne Calha DIN  
Push-in-800V/31A  
0,2-2,5mm<sup>2</sup>  
Cor: Verde/Amar.  
Qt/Emb.50pcs  
**P.U. 2,250€**

**SL-BD2025PI-G**  
Borne Duplo Nível  
Push-in-500V/22A  
0,2-2,5mm<sup>2</sup>  
Cor: Cinza  
Qt/Emb.50pcs  
**P.U. 2,200€**

**SL-BD2025PI-N**  
Borne Duplo Nível  
Push-in-500V/22A  
0,2-2,5mm<sup>2</sup>  
Cor: Azul  
Qt/Emb.50pcs  
**P.U. 2,200€**

**SL-BD2025PI-PV**  
Borne Duplo Nível  
Push-in-500V/22A  
0,2-2,5mm<sup>2</sup>  
Cor: Preto  
Qt/Emb.50pcs  
**P.U. 3,400€**

**SL-BD2025PI-PE**  
Borne Duplo Nível  
Push-in-500V/22A  
0,2-2,5mm<sup>2</sup>  
Cor: Verde/Amar.  
Qt/Emb.50pcs  
**P.U. 3,850€**

**SL-BD1004PI-G**  
Borne Calha DIN  
Push-in-800V/31A  
0,5-4mm<sup>2</sup>  
Cor: Cinza  
Qt/Emb.50pcs  
**P.U. 0,950€**

**SL-BD1004PI-B**  
Borne Calha DIN  
Push-in-800V/31A  
0,5-4mm<sup>2</sup>  
Cor: Azul  
Qt/Emb.50pcs  
**P.U. 0,950€**

**SL-BD1004PI-PE**  
Borne Calha DIN  
Push-in-800V/31A  
0,5-4mm<sup>2</sup>  
Cor: Verde/Amar.  
Qt/Emb.50pcs  
**P.U. 2,950€**

**SL-BD2004PI-G**  
Borne Duplo Nível  
Push-in-500V/22A  
0,5-4mm<sup>2</sup>  
Cor: Cinza  
Qt/Emb.50pcs  
**P.U. 3,400€**

**SL-BD2004PI-N**  
Borne Duplo Nível  
Push-in-500V/22A  
0,5-4mm<sup>2</sup>  
Cor: Azul  
Qt/Emb.50pcs  
**P.U. 3,400€**

**SL-BD2004PI-PV**  
Borne Duplo Nível  
Push-in-500V/22A  
0,5-4mm<sup>2</sup>  
Cor: Preto  
Qt/Emb.50pcs  
**P.U. 4,950€**

**SL-BD2004PI-PE**  
Borne Duplo Nível  
Push-in-500V/22A  
0,5-4mm<sup>2</sup>  
Cor: Verde/Amar.  
Qt/Emb.50pcs  
**P.U. 4,980€**



**SL-BD2225PI-G**  
Borne Dup.Linha  
Push-in-800V/31A  
0,2-2,5mm<sup>2</sup>  
Cor: Cinza  
Qt/Emb.50pcs  
**P.U. 1,550€**

**SL-BD2225PI-B**  
Borne Dup.Linha  
Push-in-800V/31A  
0,2-2,5mm<sup>2</sup>  
Cor: Azul  
Qt/Emb.50pcs  
**P.U. 1,550€**

**SL-BD2225PI-PE**  
Borne Dup.Linha  
Push-in-800V/31A  
0,2-2,5mm<sup>2</sup>  
Cor: Verde/Amar.  
Qt/Emb.50pcs  
**P.U. 3,750€**

**SL-BD2025-PE/L**  
Borne Duplo Nível  
Push-in-500V/22A  
0,2-2,5mm<sup>2</sup>  
Cor:VA/Cinza  
Qt/Emb.50pcs  
**P.U. 5,250€**

**SL-BD2025-PE/N**  
Borne Duplo Nível  
Push-in-500V/22A  
0,2-2,5mm<sup>2</sup>  
Cor:VA/Azul  
Qt/Emb.50pcs  
**P.U. 5,800€**

**SL-BD2004-PE/L**  
Borne Duplo Nível  
Push-in-500V/22A  
0,5-4mm<sup>2</sup>  
Cor:VA/Cinza  
Qt/Emb.50pcs  
**P.U. 6,500€**

**SL-BD2004-PE/N**  
Borne Duplo Nível  
Push-in-500V/22A  
0,5-4mm<sup>2</sup>  
Cor:VA/Azul  
Qt/Emb.50pcs  
**P.U. 6,950€**

**SL-BD2204PI-G**  
Borne Dup.Linha  
Push-in-800V/32A  
0,5-4mm<sup>2</sup>  
Cor: Cinza  
Qt/Emb.50pcs  
**P.U. 2,100**

**SL-BD2204PI-B**  
Borne Dup.Linha  
Push-in-800V/32A  
0,5-4mm<sup>2</sup>  
Cor: Azul  
Qt/Emb.50pcs  
**P.U. 2,100**

**SL-BD2204PI-PE**  
Borne Dup.Linha  
Push-in-800V/32A  
0,5-4mm<sup>2</sup>  
Cor: Verde/Amar.  
Qt/Emb.50pcs  
**P.U. 4,900**

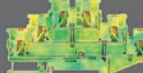

**SL-BD3025PI-G**  
Borne Triplo Nível  
Push-in-500V/22A  
0,2-2,5mm<sup>2</sup>  
Cor: Cinza  
Qt/Emb.50pcs  
**P.U. 5,200€**

**SL-BD3025PI-B**  
Borne Triplo Nível  
Push-in-500V/22A  
0,2-2,5mm<sup>2</sup>  
Cor: Azul  
Qt/Emb.50pcs  
**P.U. 5,200€**

**SL-BD3025PI-PE**  
Borne Triplo Nível  
Push-in-500V/22A  
0,2-2,5mm<sup>2</sup>  
Cor: Verde/amar.  
Qt/Emb.50pcs  
**P.U. 15,500€**

**SL-BD3025PI-PV**  
Borne Triplo Nível  
Push-in-500V/22A  
0,2-2,5mm<sup>2</sup>  
Cor: Preto  
Qt/Emb.50pcs  
**P.U. 9,200€**

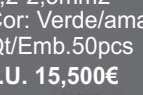

**SL-BD4025PI-G**  
Borne Quad- Linha  
Push-in-800V/31A  
0,2-2,5mm<sup>2</sup>  
Cor: Cinza  
**P.U. 2,100€**

**SL-BD4025PI-B**  
Borne Quad- Linha  
Push-in-800V/31A  
0,2-2,5mm<sup>2</sup>  
Cor: Azul  
**P.U. 2,100€**

**SL-BD4025PI-PE**  
Borne Quad- Linha  
Push-in-800V/31A  
0,2-2,5mm<sup>2</sup>  
Cor: Verde/Amar.  
**P.U. 4,900€**

**SL-BD3025PI-PE/L/N**  
Borne Triplo Nível  
Push-in-500V/22A  
0,2-2,5mm<sup>2</sup>  
Cor: VA/CZ/AZ  
Qt/Emb.50pcs  
**P.U. 11,800€**

**SL-BD3025PI-PE/L/L**  
Borne Triplo Nível  
Push-in-500V/22A  
0,2-2,5mm<sup>2</sup>  
Cor: VA/CZ/CZ  
Qt/Emb.50pcs  
**P.U. 11,950€**

**SL-BD1025PI-FLED**  
Borne Porta Fus.  
Push-in500V/22A  
0,2-2,5mm<sup>2</sup>  
Cor: Cinza  
Qt/Emb.50pcs  
**P.U. 5,500€**

**Marc.p/Bornes 2,5mm<sup>2</sup>**  
SL-BD-MA2 5-0010 (00-10)  
SL-BD-MA2 5-2130 (11-20)  
SL-BD-MA2 5-3140 (21-30)  
SL-BD-MA2 5-4150 (31-40)  
SL-BD-MA2 5-5160 (41-50)  
SL-BD-MA2 5-6170 (51-60)  
SL-BD-MA2 5-7180 (61-70)  
SL-BD-MA2 5-8190 (71-80)  
SL-BD-MA2 5-9199 (81-99)  
Preço para uma placa com 10 Numeros  
**P.U. 0,500€**

**SL-BD4004PI-G**  
Borne Quad. Linha  
Push-in-800V/32A  
0,5-4mm<sup>2</sup>  
Cor: Cinza  
**P.U. 2,950€**

**SL-BD4004PI-B**  
Borne Quad. Linha  
Push-in-800V/32A  
0,5-4mm<sup>2</sup>  
Cor: Azul  
**P.U. 2,950€**

**SL-BD4004PI-PE**  
Borne Quad. Linha  
Push-in-800V/32A  
0,5-4mm<sup>2</sup>  
Cor: Verde/Amar.  
**P.U. 6,000€**



**SL-BD-CH2,5-2**  
Shunt para Borne  
Push-in 2,5mm<sup>2</sup>  
2 Polos  
**P.U. 0,600**

**SL-BD-CH2,5-3**  
Shunt para Borne  
Push-in 2,5mm<sup>2</sup>  
3 Polos  
**P.U. 0,850**

**SL-BD-CH2,5-4**  
Shunt para Borne  
Push-in 2,5mm<sup>2</sup>  
4 Polos  
**P.U. 1,250**

**SL-BD-CH2,5-5**  
Shunt para Borne  
Push-in 2,5mm<sup>2</sup>  
5 Polos  
**P.U. 1,500**

**SL-BD-CH2,5-10**  
Shunt para Borne  
Push-in 2,5mm<sup>2</sup>  
10 Polos  
**P.U. 2,300**

**SL-BD-ETB01**  
Esquadro Travam.  
para Bornes  
sem parafusos  
Qt/Emb.50pcs  
**P.U. 0,400€**

**M.p/Bor.2e3 Niv.2,5mm<sup>2</sup>**  
SL-BD-MADT2,5-0010 (00-10)  
SL-BD-MADT2,5-2130 (11-20)  
SL-BD-MADT2,5-3140 (21-30)  
SL-BD-MADT2,5-4150 (31-40)  
SL-BD-MADT2,5-5160 (41-50)  
SL-BD-MADT2,5-6170 (51-60)  
SL-BD-MADT2,5-7180 (61-70)  
SL-BD-MADT2,5-8190 (71-80)  
SL-BD-MADT2,5-9199 (81-99)  
Preço para uma placa com 10 Numeros  
**P.U. 0,800€**

**SL-BD-CH4-2**  
Shunt para Borne  
Push-in 4mm<sup>2</sup>  
2 Polos  
**P.U. 0,750**

**SL-BD-CH4-3**  
Shunt para Borne  
Push-in 4mm<sup>2</sup>  
3 Polos  
**P.U. 1,000**

**SL-BD-CH4-4**  
Shunt para Borne  
Push-in 4mm<sup>2</sup>  
4 Polos  
**P.U. 1,500**

**SL-BD-CH4-5**  
Shunt para Borne  
Push-in 4mm<sup>2</sup>  
5 Polos  
**P.U. 1,700**

**SL-BD-CH4-10**  
Shunt para Borne  
Push-in 4mm<sup>2</sup>  
10 Polos  
**P.U. 2,700**

**M.p/Bor.2e3 Niv.4mm<sup>2</sup>**  
SL-BD-MDTA4-0010 (00-10)  
SL-BD-MDTA4-2130 (11-20)  
SL-BD-MDTA4-3140 (21-30)  
SL-BD-MDTA4-4150 (31-40)  
SL-BD-MAD4DT-5160 (41-50)  
SL-BD-MDTA4-6170 (51-60)  
SL-BD-MDTA4-7180 (61-70)  
SL-BD-MDTA4-8190 (71-80)  
SL-BD-MDTA4-9199 (81-99)  
Preço para uma placa com 10 Numeros  
**P.U. 0,900€**



# Ligadores

Novos  
Produtos



**SL-BD-TP01-2,5**

Tampa Final para Borne Push 0,2-2,5mm2  
Cor: Cinza  
Qt/Emb.50pcs  
P.U. 0,400€



**SL-BD-TP22-2,5**

Tampa Final para Borne Duplo Linha 0,2-2,5mm2  
Cor: Cinza  
Qt/Emb.50pcs  
P.U. 0,450€

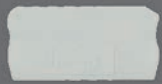

**SL-BD-TP44-2,5**

Tampa Final para Borne Quad. Linha 0,2-2,5mm2  
Cor: Cinza  
Qt/Emb.50pcs  
P.U. 0,500€



**SL-BD-TP02-2,5**

Tampa Final para Borne Duplo Nivel 0,2-2,5mm2  
Cor: Cinza  
Qt/Emb.50pcs  
P.U. 1,150€



**SL-BD-TP03-2,5**

Tampa Final para Borne Triplo Nivel 0,2-2,5mm2  
Cor: Cinza  
Qt/Emb.50pcs  
P.U. 1,700€

**SL-BD-TP01-4**

Tampa Final para Borne Push 0,5-4mm2  
Cor: Cinza  
Qt/Emb.50pcs  
P.U. 0,450€

**SL-BD-TP22-4**

Tampa Final para Borne Duplo Linha 0,5-4mm2  
Cor: Cinza  
Qt/Emb.50pcs  
P.U. 0,500€

**SL-BD-TP44-4**

Tampa Final para Borne Quad. Linha 0,5-4mm2  
Cor: Cinza  
Qt/Emb.50pcs  
P.U. 0,600€

**SL-BD-TP02-4**

Tampa Final para Borne Duplo Nivel 0,5-4mm2  
Cor: Cinza  
Qt/Emb.50pcs  
P.U. 1,200€

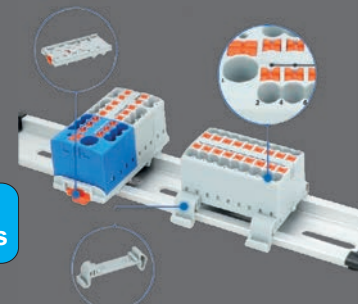

Novos  
Produtos



**SL-BD-BT6/6X2,5VD**

Bloco Terminais Push-in - 690V/41/24A 1x6 (0,5-6mm2) 6x2,5 (0,14-2,5mm2)  
Cor: Verde  
Qt/Emb. 50pcs  
P.U. 8,600€



**SL-BD-BT6/6X2,5AZ**

Bloco Terminais Push-in - 690V/41/24A 1x6 (0,5-6mm2) 6x2,5 (0,14-2,5mm2)  
Cor: Azul  
Qt/Emb. 50pcs  
P.U. 8,600€



**SL-BD-BT6/6X2,5CZ**

Bloco Terminais Push-in - 690V/41/24A 1x6 (0,5-6mm2) 6x2,5 (0,14-2,5mm2)  
Cor: Cinza  
Qt/Emb.50 pcs  
P.U. 8,600€



**SL-BD-BT6X2,5VD**

Bloco Terminais 6x2,5 Push-in - 690V/24A 6x2,5 (0,14-2,5mm2)  
Cor: Verde  
Qt/Emb. 50pcs  
P.U. 4,550€



**SL-BD-BT6X2,5AZ**

Bloco Terminais 6x2,5 Push-in - 690V/24A 6x2,5 (0,14-2,5mm2)  
Cor: Azul  
Qt/Emb. 50pcs  
P.U. 4,550€



**SL-BD-BT6X2,5CZ**

Bloco Terminais Push-in - 690V/24A 6x2,5 (0,14-2,5mm2)  
Cor: Cinza  
Qt/Emb. 50pcs  
P.U. 4,550€



**SL-BD-BT-SUP-01**

Suporte Horizontal P/ Calha DIN 35mm  
Cor: Cinza  
Qt/Emb. 50pcs  
P.U. 0,700€



**SL-BD-BT-SUP-02**

Suporte Vertical P/ Calha DIN 35mm  
Cor: Cinza  
Qt/Emb. 50pcs  
P.U. 1,350€



**SL-BD-BT-SUP-03**

Suporte Horizontal P/ Calha DIN 15mm  
Cor: Cinza  
Qt/Emb. 50pcs  
P.U. 0,750€



**SL-BD-BT-TOPO**

Topo para/Fixador Bloco terminais  
Cor: Cinza  
Qt/Emb. 50pcs  
P.U. 1,200€



**SL-BD-BT-ETIQ**

Etiqueta para Identificação de Bloco terminais  
Cor: Cinza  
P.U. 0,850€



**SL-BD1025G**

Borne Calha DIN 0,2-2,5mm2  
Cor: Cinza  
Qt/Emb. 50pcs  
P.U. 0,52€



**SL-BD1004G**

Borne Calha DIN 0,2-4mm2  
Cor: Cinza  
Qt/Emb. 50pcs  
P.U. 0,58€



**SL-BD1006G**

Borne Calha DIN 0,2-6mm2  
Cor: Cinza  
Qt/Emb. 50pcs  
P.U. 1,00€



**SL-BD1010G**

Borne Calha DIN 0,5-10mm2  
Cor: Cinza  
Qt/Emb. 40pcs  
P.U. 1,45€



**SL-BD1025B**

Borne Calha DIN 0,2-2,5mm2  
Cor: Azul  
Qt/Emb. 50pcs  
P.U. 0,52€



**SL-BD1004B**

Borne Calha DIN 0,2-4mm2  
Cor: Azul  
Qt/Emb. 50pcs  
P.U. 0,58€



**SL-BD1006B**

Borne Calha DIN 0,2-6mm2  
Cor: Azul  
Qt/Emb. 40pcs  
P.U. 1,00€



**SL-BD1010B**

Borne Calha DIN 0,5-10mm2  
Cor: Azul  
Qt/Emb. 40pcs  
P.U. 1,45€



**SL-BD1025Y**

Borne Calha DIN 0,2-2,5mm2  
Cor: Verde/Amarelo  
Qt/Emb. 100pcs  
P.U. 1,85€



**SL-BD1004Y**

Borne Calha DIN 0,2-4mm2  
Cor: Verde/Amarelo  
Qt/Emb. 100pcs  
P.U. 1,90€



**SL-BD1006Y**

Borne Calha DIN 0,2-6mm2  
Cor: Verde/Amarelo  
Qt/Emb. 50pcs  
P.U. 2,45€



**SL-BD1010Y**

Borne Calha DIN 0,5-10mm2  
Cor: Verde/Amarelo  
Qt/Emb. 50pcs  
P.U. 2,65€



**SL-BD2025G**

Borne Calha DIN 0,2-2,5mm2  
Cor: Cinza  
Qt/Emb. 50pcs  
P.U. 1,16€



**SL-BD2040G**

Borne Calha DIN 0,2-4mm2  
Cor: Cinza  
Qt/Emb. 50pcs  
P.U. 1,35€



**SL-BD-END**

Borne Fixação  
Cor: Cinza  
Qt/Emb. 100pcs  
P.U. 0,30€



**SL-BD1025-M**

Marcações para Borne 2,5mm Numéricas 1 a 10  
Qt/Emb.10pcs  
P.U. 0,22€



**SL-BD1004-M**

Marcações para Borne 4mm Numéricas 1 a 10  
Qt/Emb. 100 Unidades  
P.U. 0,22€



**SL-BD1006-M**

Marcações para Borne 6mm Numéricas 1 a 10  
Qt/Emb. 100 Unidades  
P.U. 0,30€



**SL-BD1010-M**

Marcações para Borne 6mm Numéricas 1 a 10  
Qt/Emb. 100 Unidades  
P.U. 0,30€

### Sinalizador em Led



Código	Cor	Fio	Tensão	P.U.€
SL-SI-S010VM-024	Vermelho	200mm	24Vdc	1,50€
SL-SI-S010VD-024	Verde	200mm	24Vdc	1,50€
SL-SI-S010AM-024	Amarelo	200mm	24Vdc	1,50€
SL-SI-S010VM-230	Vermelho	200mm	230Vac	1,50€
SL-SI-S010VD-230	Verde	200mm	230Vac	1,50€
SL-SI-S010AM-230	Amarelo	200mm	230Vac	1,50€
SL-SI-S010VM-400	Vermelho	200mm	400Vac	1,50€
SL-SI-S010VD-400	Verde	200mm	400Vac	1,50€
SL-SI-S010AM-400	Amarelo	200mm	400Vac	1,50€

### Sinalizador em Led



Código	Cor	Fio	Tensão	P.U.€
SL-SI-S020VM-024	Vermelho	300mm	24Vdc	1,50€
SL-SI-S020VD-024	Verde	300mm	24Vdc	1,50€
SL-SI-S020AM-024	Amarelo	300mm	24Vdc	1,50€
SL-SI-S020VM-230	Vermelho	300mm	230Vac	1,50€
SL-SI-S020VD-230	Verde	300mm	230Vac	1,50€
SL-SI-S020AM-230	Amarelo	300mm	230Vac	1,50€
SL-SI-S020VM-400	Vermelho	300mm	400Vac	1,50€
SL-SI-S020VD-400	Verde	300mm	400Vac	1,50€
SL-SI-S020AM-400	Amarelo	300mm	400Vac	1,50€

### Interruptores Painel 230Vac

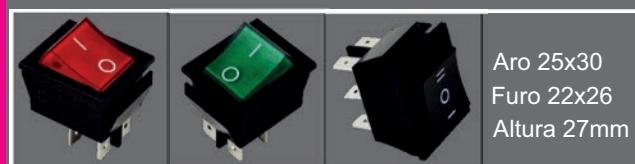

Código	Cor	Tensão	P.U.€
SL-SI-I010VM-230	Vermelho	230Vac	3,20€
SL-SI-I010VD-230	Verde	230Vac	3,20€
SL-SI-I010-2X3PT	Preto	230Vac	3,50€
SL-SI-I010SILPRO	Silicone Proteção		1,10€

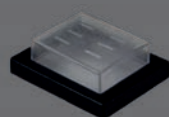

Código	Cor	P.U.€
SL-SI-I010SILPRO	Silicone Proteção	1,00€

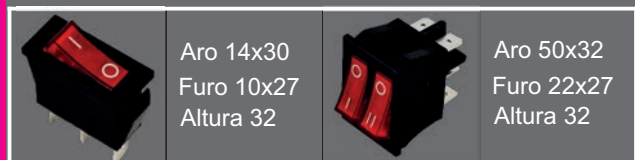

Código	Cor	Botões	Tensão	P.U.€
SL-SI-I020VM-230	Vermelho	1 Botão	230Vac	2,95€

Código	Cor	Botões	Tensão	P.U.€
SL-SI-I020DVM-230	Vermelho	2 Botões	230Vac	4,60€

### Interruptores Alavanca 230Vac

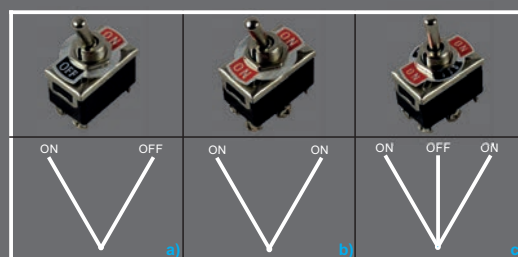

Código	Função	Dimensões	Furo	P.U.€
SL-SI-I1010-1P-10A	ON-OFF	19x29mm	12mm	2,55€ a)
SL-SI-I1015-1P-10A	ON-ON	19x29mm	12mm	2,90€ b)
SL-SI-I1020-1P-10A	ON-OFF-ON	19x29mm	12mm	2,90€ c)
SL-SI-I1010-2P-10A	ON-OFF	20x32mm	12mm	3,50€ a)
SL-SI-I1015-2P-10A	ON-ON	20x32mm	12mm	3,50€ b)
SL-SI-I1020-2P-10A	ON-OFF-ON	20x32mm	12mm	3,50€ c)



Código	Cor	Tensão	P.U.€
SL-SI-I030VM-230	Ver.Lum.0-1	230Vac	2,95€ a)
SL-SI-I030PT-230	Preto 0-1	230Vac	1,95€ a)
SL-SI-I032PT-230	Preto 1-0-2	230Vac	3,20€ b)



Código	Cor	Tensão	P.U.€
SL-SI-I030SILPRO	Silicone Proteção	230Vac	0,70€

# Bucins Nylon

soflight®

Electric

## Bucins para Cabo

Material: PA6.6 Classe UL94-V-2

Grau de Proteção IP 68

Temperatura trabalho: -30°C / 80°C

Tipo Rosca: Métrica ou PG

## Livre de Halogénios

Nova Cor

RAL 7001 ( Cinza Escuro / Antracite )

RAL 7035 ( Cinza Claro )

RAL 9005 ( Preto )



Novos Podutos



Novos Podutos

Código	Rosca	Qty Min. Venda	P.U.€
SL-B1007-CZ	PG 7 Cinza	100 unid.	0,20€
SL-B1007-PT	PG 7 Preto	100 unid.	0,20€
SL-B1007-AN	PG 7 Antracite	100 unid.	0,20€
SL-B1009-CZ	PG 9 Cinza	100 unid.	0,23€
SL-B1009-PT	PG 9 Preto	100 unid.	0,23€
SL-B1009-AN	PG 9 Antracite	100 unid.	0,23€
SL-B1011-CZ	PG 11 Cinza	100 unid.	0,25€
SL-B1011-PT	PG 11 Preto	100 unid.	0,25€
SL-B1011-AN	PG 11 Antracite	100 unid.	0,25€
SL-B1013-CZ	PG 13,5 Cinza	100 unid.	0,33€
SL-B1013-PT	PG 13,5 Preto	100 unid.	0,33€
SL-B1013-AN	PG 13,5 Antracite	100 unid.	0,33€
SL-B1016-CZ	PG 16 Cinza	100 unid.	0,36€
SL-B1016-PT	PG 16 Preto	100 unid.	0,36€
SL-B1016-AN	PG 16 Antracite	100 unid.	0,36€
SL-B1021-CZ	PG 21 Cinza	100 unid.	0,58€
SL-B1021-PT	PG 21 Preto	100 unid.	0,58€
SL-B1021-AN	PG 21 Antracite	100 unid.	0,58€
SL-B1029-CZ	PG 29 Cinza	100 unid.	0,97€
SL-B1029-PT	PG 29 Preto	100 unid.	0,97€
SL-B1029-AN	PG 29 Antracite	100 unid.	0,97€
SL-B1036-CZ	PG 36 Cinza	100 unid.	1,70€
SL-B1036-PT	PG 36 Preto	100 unid.	1,70€
SL-B1036-AN	PG 36 Antracite	100 unid.	1,70€
SL-B1042-CZ	PG 42 Cinza	100 unid.	2,20€
SL-B1042-PT	PG 42 Preto	100 unid.	2,20€
SL-B1042-AN	PG 42 Antracite	100 unid.	2,20€
SL-B1048-CZ	PG 48 Cinza	100 unid.	2,80€
SL-B1048-PT	PG 48 Preto	100 unid.	2,80€
SL-B1048-AN	PG 48 Antracite	100 unid.	2,80€
SL-B1063-CZ	PG 63 Cinza	100 unid.	5,40€
SL-B1063-PT	PG 63 Preto	100 unid.	5,40€

Código	Rosca	Qty Min. Venda	P.U.€
SL-M1012-CZ	M 12 Cinza	100 unid.	0,27€
SL-M1012-PT	M 12 Preto	100 unid.	0,27€
SL-M1012-AN	M 12 Antracite	100 unid.	0,27€
SL-M1016-CZ	M 12 Cinza	100 unid.	0,32€
SL-M1016-PT	M 12 Preto	100 unid.	0,32€
SL-M1016-AN	M 12 Antracite	100 unid.	0,32€
SL-M1020-CZ	M 20 Cinza	100 unid.	0,39€
SL-M1020-PT	M 20 Preto	100 unid.	0,39€
SL-M1020-AN	M 20 Antracite	100 unid.	0,39€
SL-M1025-CZ	M 25 Cinza	100 unid.	0,60€
SL-M1025-PT	M 25 Preto	100 unid.	0,60€
SL-M1025-AN	M 25 Antracite	100 unid.	0,60€
SL-M1032-CZ	M 32 Cinza	100 unid.	0,97€
SL-M1032-PT	M 32 Preto	100 unid.	0,97€
SL-M1032-AN	M 32 Antracite	100 unid.	0,97€
SL-M1040-CZ	M 40 Cinza	100 unid.	1,93€
SL-M1040-PT	M 40 Preto	100 unid.	1,93€
SL-M1040-AN	M 40 Antracite	100 unid.	1,93€
SL-M1050-CZ	M 50 Cinza	100 unid.	2,75€
SL-M1050-PT	M 50 Preto	100 unid.	2,75€
SL-M1050-AN	M 50 Antracite	100 unid.	2,75€
SL-M1050-CZ	M 50 Cinza	100 unid.	3,20€
SL-M1050-PT	M 50 Preto	100 unid.	3,20€
SL-M1050-AN	M 50 Antracite	100 unid.	3,20€

### Bucins para Cabo

Material: Latão Niquelado  
Grau de Proteção IP 68  
Temperatura trabalho: -30°C / 80°C



### Bucins para Cabo

Material: Inox 316  
Grau de Proteção IP 68  
Temperatura trabalho: -30°C / 80°C



### Bucim Metálico, PG

### Bucim Inox 316, PG

Código	Rosca	Qty Min. Venda	P.U.€
SL-B2007-MT	PG 7 Metálico	200	1,42€
SL-B2009-MT	PG 9 Metálico	100	1,58€
SL-B2011-MT	PG 11 Metálico	100	1,90€
SL-B2013-MT	PG 13,5 Metálico	100	2,10€
SL-B2016-MT	PG 16 Metálico	50	2,50€
SL-B2021-MT	PG 21 Metálico	50	3,75€
SL-B2029-MT	PG 29 Metálico	20	7,75€
SL-B2036-MT	PG 36 Metálico	12	15,30€
SL-B2042-MT	PG 42 Metálico	6	16,80€
SL-B2048-MT	PG 48 Metálico	6	24,75€

Código	Rosca	Ø Cabos	Qty Min. Venda	P.U.€
SL-BI31607	PG 7	3-6,5mm	10unid.	16,00€
SL-BI31609	PG 9	4-8mm	10unid.	21,00€
SL-BI31611	PG 11	5-10mm	10unid.	22,50€
SL-BI31613	PG 13,5	6-12mm	10unid.	23,20€
SL-BI31616	PG 16	10-14mm	10unid.	25,50€
SL-BI31621	PG 21	13-18mm	10unid.	27,00€
SL-BI31629	PG 29	18-25mm	10unid.	30,30€
SL-BI31636	PG 36	25-33mm	10unid.	61,00€
SL-BI31642	PG 42	32-38mm	10unid.	147,50€
SL-BI31648	PG 48	37-44mm	10unid.	190,00€



### Bucim Metálico, Métrico

### Bucim Inox 316, Métrico

Código	Rosca	Qty Min. Venda	P.U.€
SL-M2012-MT	M 12 Metálico(3-6,5mm)	100	1,58€
SL-M2016-MT	M 16 Metálico(4-8mm)	50	1,80€
SL-M2016-S-MT	M 16 Metálico (6-12mm)	10	1,80€
SL-M2018-MT	M 18 Metálico(5-10mm)	50	1,80€
SL-M2020-MT	M 20 Metálico(6-12mm)	20	2,65€
SL-M2022-MT	M 22 Metálico(10-14mm)	20	2,65€
SL-M2025-MT	M 25 Metálico(13-18mm)	20	3,15€
SL-M2028-MT	M 28 Metálico(13-18mm)	20	3,80€
SL-M2032-MT	M 32 Metálico(15-22mm)	12	5,80€
SL-M2037-MT	M 37 Metálico(18-25mm)	12	5,80€
SL-M2040-MT	M 40 Metálico(22-30mm)	12	9,00€
SL-M2050-MT	M 50 Metálico(32-38mm)	9	15,30€
SL-M2063-MT	M 63 Metálico(37-44mm)	6	26,90€
SL-M2075-MT	M 75 Metálico(42-52mm)	4	100,00€
SL-M2080-MT	M 80 Metálico(55-62mm)	4	175,00€
SL-M20100-MT	M 100 Metálico(78-84mm)	2	340,00€

Código	Rosca	Ø Cabos	Qty Min. Venda	P.U.€
SL-MI31612	M12	3-6,5mm	10unid.	16,00€
SL-MI31616	M16	4-8mm	10unid.	21,00€
SL-MI31620	M20	6-12mm	10unid.	24,50€
SL-MI31625	M25	10-14mm	10unid.	23,30€
SL-MI31632	M32	15-22mm	10unid.	34,70€
SL-MI31640	M40	18-25mm	10unid.	50,00€
SL-MI31650	M50	32-38mm	10unid.	69,70€
SL-MI31663	M63	37-44mm	10unid.	158,00€
SL-MI31675	M75	42-52mm	10unid.	280,00€
SL-MI31680	M80	37-44mm	10unid.	342,00€
SL-MI316100	M100	78-84mm	10unid.	495,00€

## Tampões Roscados em Nylon

Material: Nylon  
Material: IP 65 / 68  
Temperatura trabalho: -30°C / 80°C



## Tampões Roscados em Nylon

Material: Nylon  
Material: IP 65 / 68  
Temperatura trabalho: -30°C / 80°C



## Tampões em Nylon PG

Código	Rosca	Cor	Acab.	Qty Min. Venda	P.U.€
SL-TPP07CZ	PG 7	Cinza	Nylon	10unid.	0,21€
SL-TPP07PT	PG 7	Preto	Nylon	10unid.	0,21€
SL-TPP09CZ	PG 9	Cinza	Nylon	10unid.	0,26€
SL-TPP09PT	PG 9	Preto	Nylon	10unid.	0,26€
SL-TPP11CZ	PG 11	Cinza	Nylon	10unid.	0,30€
SL-TPP11PT	PG 11	Preto	Nylon	10unid.	0,30€
SL-TPP13CZ	PG 13,5	Cinza	Nylon	10unid.	0,35€
SL-TPP13PT	PG 13,5	Preto	Nylon	10unid.	0,35€
SL-TPP16CZ	PG 16	Cinza	Nylon	10unid.	0,40€
SL-TPP16PT	PG 16	Preto	Nylon	10unid.	0,340
SL-TPP21CZ	PG 21	Cinza	Nylon	10unid.	0,56€
SL-TPP21PT	PG 21	Preto	Nylon	10unid.	0,56€
SL-TPP29CZ	PG 29	Cinza	Nylon	10unid.	0,77€
SL-TPP29PT	PG 29	Preto	Nylon	10unid.	0,77€
SL-TPP36CZ	PG 36	Cinza	Nylon	10unid.	1,50€
SL-TPP36PT	PG 36	Preto	Nylon	10unid.	1,50€
SL-TPP42CZ	PG 42	Cinza	Nylon	10unid.	1,95€
SL-TPP42PT	PG 42	Preto	Nylon	10unid.	1,95€
SL-TPP48CZ	PG 48	Cinza	Nylon	10unid.	2,50€
SL-TPP48PT	PG 48	Preto	Nylon	10unid.	2,50€

## Tampões em Nylon Métricos

Código	Rosca	Cor	Acab.	Qty Min. Venda	P.U.€
SL-TPM12CZ	M12	Cinza	Nylon	10unid.	0,22€
SL-TPM12PT	M12	Preto	Nylon	10unid.	0,22€
SL-TPM16CZ	M16	Cinza	Nylon	10unid.	0,28€
SL-TPM16PT	M16	Preto	Nylon	10unid.	0,28€
SL-TPM20CZ	M20	Cinza	Nylon	10unid.	0,30€
SL-TPM20PT	M20	Preto	Nylon	10unid.	0,30€
SL-TPM25CZ	M25	Cinza	Nylon	10unid.	0,45€
SL-TPM25PT	M25	Preto	Nylon	10unid.	0,45€
SL-TPM32CZ	M32	Cinza	Nylon	10unid.	0,55€
SL-TPM32PT	M32	Preto	Nylon	10unid.	0,55€
SL-TPM40CZ	M40	Cinza	Nylon	10unid.	0,99€
SL-TPM40PT	M40	Preto	Nylon	10unid.	0,99€
SL-TPM50CZ	M50	Cinza	Nylon	10unid.	1,95€
SL-TPM50PT	M50	Preto	Nylon	10unid.	1,95€
SL-TPM63CZ	M63	Cinza	Nylon	10unid.	2,50€
SL-TPM63PT	M63	Preto	Nylon	10unid.	2,50€

## Tampões em Latão PG

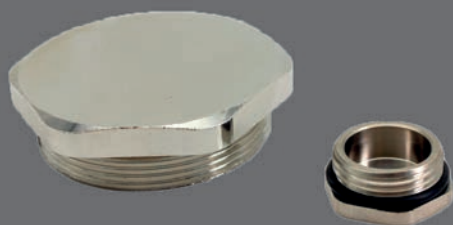

## Tampões em Latão Métricos

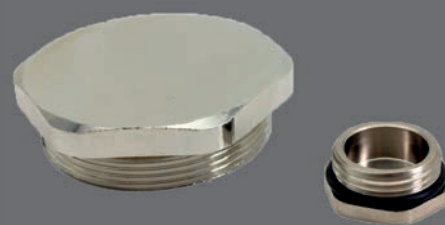

Código	Rosca	Material	Acab.	Qty Min. Venda	P.U.€
SL-TMP07NI	PG 7	Latão	Niquelado	10unid.	1,40€
SL-TMP09NI	PG 9	Latão	Niquelado	10unid.	1,70€
SL-TMP11NI	PG 11	Latão	Niquelado	10unid.	1,80€
SL-TMP09NI	PG 13,5	Latão	Niquelado	10unid.	1,99€
SL-TMP16NI	PG 16	Latão	Niquelado	10unid.	2,30€
SL-TMP21NI	PG 21	Latão	Niquelado	10unid.	3,50€
SL-TMP29NI	PG 29	Latão	Niquelado	10unid.	7,10€
SL-TMP36NI	PG 36	Latão	Niquelado	10unid.	11,50€
SL-TMP42NI	PG 42	Latão	Niquelado	10unid.	14,50€
SL-TMP48NI	PG 48	Latão	Niquelado	10unid.	22,20€

Código	Rosca	Material	Acab.	Qty Min. Venda	P.U.€
SL-TMM12NI	M12	Latão	Niquelado	10unid.	1,50€
SL-TMM16NI	M16	Latão	Niquelado	10unid.	1,70€
SL-TMM20NI	M20	Latão	Niquelado	10unid.	2,10€
SL-TMM25NI	M25	Latão	Niquelado	10unid.	3,20€
SL-TMM32NI	M32	Latão	Niquelado	10unid.	4,50€
SL-TMM40NI	M40	Latão	Niquelado	10unid.	8,60€
SL-TMM50NI	M50	Latão	Niquelado	10unid.	14,80€
SL-TMM63NI	M63	Latão	Niquelado	10unid.	22,10€

### Porcas em Nylon

Material: Nylon  
Material: IP 65 / 68  
Temperatura trabalho: -30°C / 80°C



### Porcas em Nylon

Material: Nylon  
Material: IP 65 / 68  
Temperatura trabalho: -30°C / 80°C



### Porcas PG em Nylon

Novos  
Podutos

### Porcas Métricas em Nylon

Novos  
Podutos

Código	Rosca	Cor	Acab.	Qty Min. Venda	P.U.€
SL-POP07CZ	PG 7	Cinza	Nylon	10unid.	0,06€
SL-POP07PT	PG 7	Preto	Nylon	10unid.	0,06€
SL-POP09CZ	PG 9	Cinza	Nylon	10unid.	0,10€
SL-POP09PT	PG 9	Preto	Nylon	10unid.	0,10€
SL-POP11CZ	PG 11	Cinza	Nylon	10unid.	0,11€
SL-POP11PT	PG 11	Preto	Nylon	10unid.	0,11€
SL-POP13CZ	PG 13,5	Cinza	Nylon	10unid.	0,13€
SL-POP13PT	PG 13,5	Preto	Nylon	10unid.	0,13€
SL-POP16CZ	PG 16	Cinza	Nylon	10unid.	0,14€
SL-POP16PT	PG 16	Preto	Nylon	10unid.	0,14€
SL-POP21CZ	PG 21	Cinza	Nylon	10unid.	0,20€
SL-POP21PT	PG 21	Preto	Nylon	10unid.	0,20€
SL-POP29CZ	PG 29	Cinza	Nylon	10unid.	0,60€
SL-POP29PT	PG 29	Preto	Nylon	10unid.	0,60€
SL-POP36CZ	PG 36	Cinza	Nylon	10unid.	0,65€
SL-POP36PT	PG 36	Preto	Nylon	10unid.	0,65€
SL-POP42CZ	PG 42	Cinza	Nylon	10unid.	0,95€
SL-POP42PT	PG 42	Preto	Nylon	10unid.	0,95€
SL-POP48CZ	PG 48	Cinza	Nylon	10unid.	1,90€
SL-POP48PT	PG 48	Preto	Nylon	10unid.	1,90€
SL-POP63CZ	PG 63	Cinza	Nylon	10unid.	2,50€
SL-POP63PT	PG 63	Preto	Nylon	10unid.	2,50€

Código	Rosca	Cor	Acab.	Qty Min. Venda	P.U.€
SL-POPM12CZ	M12	Cinza	Nylon	10unid.	0,06€
SL-POPM12PT	M12	Preto	Nylon	10unid.	0,06€
SL-POPM16CZ	M16	Cinza	Nylon	10unid.	0,10€
SL-POPM16PT	M16	Preto	Nylon	10unid.	0,10€
SL-POPM20CZ	M20	Cinza	Nylon	10unid.	0,13€
SL-POPM20PT	M20	Preto	Nylon	10unid.	0,13€
SL-POPM25CZ	M25	Cinza	Nylon	10unid.	0,20€
SL-POPM25PT	M25	Preto	Nylon	10unid.	0,20€
SL-POPM32CZ	M32	Cinza	Nylon	10unid.	0,25€
SL-POPM32PT	M32	Preto	Nylon	10unid.	0,25€
SL-POPM40CZ	M40	Cinza	Nylon	10unid.	0,60€
SL-POPM40PT	M40	Preto	Nylon	10unid.	0,60€
SL-POPM50CZ	M50	Cinza	Nylon	10unid.	0,75€
SL-POPM50PT	M50	Preto	Nylon	10unid.	0,75€
SL-POPM63CZ	M63	Cinza	Nylon	10unid.	1,90€
SL-POPM63PT	M63	Preto	Nylon	10unid.	1,90€
SL-POPM80CZ	M80	Cinza	Nylon	10unid.	5,00€
SL-POPM80PT	M80	Preto	Nylon	10unid.	5,00€
SL-POPM100CZ	M100	Cinza	Nylon	10unid.	6,50€
SL-POPM100PT	M100	Preto	Nylon	10unid.	6,50€

### Porcas PG em Latão



Novos  
Podutos

### Porcas Métricas em Latão



Novos  
Podutos

Código	Rosca	Material	Acab.	Qty Min. Venda	P.U.€
SL-POP07NI	PG 7	Latão	Niquelado	10unid.	0,30€
SL-POP09NI	PG 9	Latão	Niquelado	10unid.	0,35€
SL-POP11NI	PG 11	Latão	Niquelado	10unid.	0,40€
SL-POP09NI	PG 13,5	Latão	Niquelado	10unid.	0,42€
SL-POP16NI	PG 16	Latão	Niquelado	10unid.	0,50€
SL-POP21NI	PG 21	Latão	Niquelado	10unid.	0,85€
SL-POP29NI	PG 29	Latão	Niquelado	10unid.	2,40€
SL-POP36NI	PG 36	Latão	Niquelado	10unid.	3,90€
SL-POP42NI	PG 42	Latão	Niquelado	10unid.	5,00€
SL-POP48NI	PG 48	Latão	Niquelado	10unid.	9,30€
SL-POP63NI	PG 63	Latão	Niquelado	10unid.	13,70€

Código	Rosca	Material	Acab.	Qty Min. Venda	P.U.€
SL-POM12NI	M12	Latão	Niquelado	10unid.	0,30€
SL-POM16NI	M16	Latão	Niquelado	10unid.	0,30€
SL-POM20NI	M20	Latão	Niquelado	10unid.	0,40€
SL-POM25NI	M25	Latão	Niquelado	10unid.	0,70€
SL-POM32NI	M32	Latão	Niquelado	10unid.	1,10€
SL-POM40NI	M40	Latão	Niquelado	10unid.	2,50€
SL-POM50NI	M50	Latão	Niquelado	10unid.	4,50€
SL-POM63NI	M63	Latão	Niquelado	10unid.	11,00€
SL-POM75NI	M75	Latão	Niquelado	10unid.	14,30€
SL-POM80NI	M80	Latão	Niquelado	10unid.	18,00€
SL-POM10NI	M100	Latão	Niquelado	10unid.	25,00€

# Bucins Ventilados

soflight®

Electric

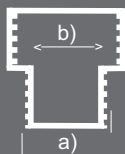

## Redução Metálica

Código	Med.Ext. a)	Med.Int. b)	Qty Min. Venda	P.U.€
SL-RPMM-10CZ	M16	M12	10unid.	1,30€
SL-RPMM-20CZ	M20	M16	10unid.	1,20€
SL-RPMM-30CZ	M25	M20	10unid.	1,50€
SL-RPMM-40CZ	M32	M25	10unid.	1,90€



## Tampões Ventilados Nylon Métricos

Código	Rosca	Cor	Acab.	Qty Min. Venda	P.U.€
SL-TPMV06CZ	M6X1	Cinza	Nylon	10unid.	1,20€
SL-TPMV08PT	M8X1,25	Cinza	Nylon	10unid.	1,50€
SL-TPMV10CZ	M10X1,5	Cinza	Nylon	10unid.	1,50€
SL-TPMV12CZ	M12X1,5	Cinza	Nylon	10unid.	1,50€
SL-TPMV16CZ	M16X1,5	Cinza	Nylon	10unid.	1,80€

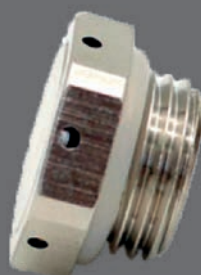

## Bucim Latão Niquelado Ventilado

Código	Rosca	Ø Cabos	Qty Min. Venda	P.U.€
SL-BV2007NI	PG 7	3-6,5mm	10unid.	4,50€
SL-BV2009NI	PG 9	4-8mm	10unid.	6,50€
SL-BV2011NI	PG 11	5-10mm	10unid.	7,70€
SL-BV2013NI	PG 13,5	6-12mm	10unid.	8,50€
SL-BV2016NI	PG 16	10-14mm	10unid.	10,00€

Código	Rosca	Material	Acab.	Qty Min. Venda	P.U.€
SL-TMMV12NI	M12X1,5	Latão	Niquelado	10unid.	7,70€
SL-TMMV16NI	M16X1,5	Latão	Niquelado	10unid.	12,00€
SL-TMMV20NI	M20X1,5	Latão	Niquelado	10unid.	18,50€

Código	Rosca	Ø Cabos	Qty Min. Venda	P.U.€
SL-MV2012NI	M12	3-6,5mm	10unid.	3,25€
SL-MV2016NI	M16	4-8mm	10unid.	6,50€
SL-MV2020NI	M20	6-12mm	10unid.	8,90€
SL-MV2025NI	M25	10-14mm	10unid.	14,70€
SL-MV2032NI	M32	15-22mm	10unid.	21,00€



Código	Descrição	Qty Min. Venda	P.U.€
SL-PF-20	Passa Fios, Furo 20mm	100	0,17€
SL-PF-32	Passa Fios, Furo 32mm	100	0,29€

Código	Descrição	Qty Min. Venda	P.U.€
SL-PF	Passa Fios, Furo 20mm	100	0,17€

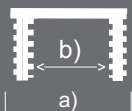

## Redução Metálica

Código	Med.Ext. a)	Med.Int. b)	Qty Min. Venda	P.U.€
SL-RMMM-01NI	M16X1,5	M12X1,5	10unid.	1,70€
SL-RMMM-02NI	M20X1,5	M12X1,5	10unid.	2,10€
SL-RMMM-03NI	M20X1,5	M16X1,5	10unid.	1,90€
SL-RMMM-04NI	M25X1,5	M16X1,5	10unid.	3,45€
SL-RMMM-05NI	M25X1,5	M20X1,5	10unid.	3,10€
SL-RMMM-06NI	M32X1,5	M16X1,5	10unid.	6,60€
SL-RMMM-07NI	M32X1,5	M20X1,5	10unid.	5,75€
SL-RMMM-08NI	M32X1,5	M25X1,5	10unid.	5,75€
SL-RMMM-09NI	M40X1,5	M20X1,5	10unid.	9,75€
SL-RMMM-10NI	M40X1,5	M25X1,5	10unid.	9,95€
SL-RMMM-11NI	M40X1,5	M32X1,5	10unid.	9,95€
SL-RMMM-12NI	M50X1,5	M25X1,5	10unid.	16,60€
SL-RMMM-13NI	M50X1,5	M32X1,5	10unid.	16,60€
SL-RMMM-14NI	M50X1,5	M40X1,5	10unid.	16,60€
SL-RMMM-15NI	M63X1,5	M32X1,5	10unid.	24,90€
SL-RMMM-16NI	M63X1,5	M40X1,5	10unid.	24,90€
SL-RMMM-17NI	M63X1,5	M50X1,5	10unid.	24,90€

## Redução PG

Código	Med.Ext. a)	Med.Int. b)	Qty Min. Venda	P.U.€
SL-RMPP-01NI	PG 9	PG 7	10unid.	1,20€
SL-RMPP-02NI	PG 11	PG 9	10unid.	1,65€
SL-RMPP-03NI	PG 13,5	PG 7	10unid.	2,80€
SL-RMPP-04NI	PG 13,5	PG 9	10unid.	2,80€
SL-RMPP-05NI	PG 13,5	PG 11	10unid.	1,85€
SL-RMPP-06NI	PG 16	PG 9	10unid.	2,60€
SL-RMPP-07NI	PG 16	PG 11	10unid.	2,90€
SL-RMPP-08NI	PG 16	PG 13,5	10unid.	2,60€
SL-RMPP-09NI	PG 21	PG 11	10unid.	3,95€
SL-RMPP-10NI	PG 21	PG 13,5	10unid.	3,95€
SL-RMPP-11NI	PG 21	PG 16	10unid.	3,60€
SL-RMPP-12NI	PG 29	PG 13,5	10unid.	7,80€
SL-RMPP-13NI	PG 29	PG 16	10unid.	7,50€
SL-RMPP-14NI	PG 29	PG 21	10unid.	5,80€
SL-RMPP-15NI	PG 36	PG 16	10unid.	12,90€
SL-RMPP-16NI	PG 36	PG 21	10unid.	11,95€
SL-RMPP-17NI	PG 36	PG 29	10unid.	11,80€
SL-RMPP-18NI	PG 42	PG 21	10unid.	25,95€
SL-RMPP-19NI	PG 42	PG 29	10unid.	26,95€
SL-RMPP-20NI	PG 42	PG 36	10unid.	21,95€
SL-RMPP-21NI	PG 48	PG 29	10unid.	28,90€
SL-RMPP-22NI	PG 48	PG 36	10unid.	26,80€
SL-RMPP-23NI	PG 48	PG 42	10unid.	27,95€

## Adaptador PG / Metálico

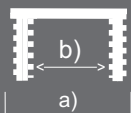

Código	Med.Ext. a)	Med.Int. b)	Qty Min. Venda	P.U.€
SL-AMPM-01NI	PG 7X1,5	M12X1,5	10unid.	1,80€
SL-AMPM-02NI	PG 9X1,5	M16X1,5	10unid.	2,35€
SL-AMPM-03NI	PG 9X1,5	M20X1,5	10unid.	2,90€
SL-AMPM-04NI	PG 11X1,5	M20X1,5	10unid.	2,95€
SL-AMPM-05NI	PG 11X1,5	M25X1,5	10unid.	4,99€
SL-AMPM-06NI	PG 13,5X1,5	M20X1,5	10unid.	3,60€
SL-AMPM-07NI	PG 13,5X1,5	M25X1,5	10unid.	4,95€
SL-AMPM-08NI	PG 16X1,5	M25X1,5	10unid.	4,95€
SL-AMPM-09NI	PG 16X1,5	M32X1,5	10unid.	8,95€
SL-AMPM-10NI	PG 21X1,5	M32X1,5	10unid.	9,10€
SL-AMPM-11NI	PG 21X1,5	M40X1,5	10unid.	12,60€
SL-AMPM-12NI	PG 29X1,5	M40X1,5	10unid.	12,60€
SL-AMPM-13NI	PG 29X1,5	M50X1,5	10unid.	23,80€
SL-AMPM-14NI	PG 36X1,5	M50X1,5	10unid.	23,08€
SL-AMPM-15NI	PG 42X1,5	M50X1,5	10unid.	21,50€
SL-AMPM-16NI	PG 42X1,5	M63X1,5	10unid.	42,00€
SL-AMPM-17NI	PG 48X1,5	M63X1,5	10unid.	42,00€

# Reduções / Ampliações

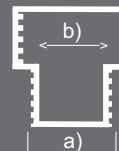
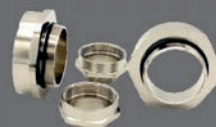

## Ampliação Metálica

Código	Med.Ext. a)	Med.Int. b)	Qty Min. Venda	P.U.€
SL-AMMM-01NI	M12X1,5	M16X1,5	10unid.	1,60€
SL-AMMM-02NI	M12X1,5	M20X1,5	10unid.	2,30€
SL-AMMM-03NI	M16X1,5	M20X1,5	10unid.	2,30€
SL-AMMM-04NI	M16X1,5	M25X1,5	10unid.	3,95€
SL-AMMM-05NI	M16X1,5	M32X1,5	10unid.	7,60€
SL-AMMM-06NI	M20X1,5	M25X1,5	10unid.	3,50€
SL-AMMM-07NI	M20X1,5	M32X1,5	10unid.	6,60€
SL-AMMM-08NI	M20X1,5	M40X1,5	10unid.	9,90€
SL-AMMM-09NI	M25X1,5	M32X1,5	10unid.	5,80€
SL-AMMM-10NI	M25X1,5	M40X1,5	10unid.	9,90€
SL-AMMM-11NI	M25X1,5	M50X1,5	10unid.	18,90€
SL-AMMM-12NI	M32X1,5	M40X1,5	10unid.	18,00€
SL-AMMM-13NI	M32X1,5	M50X1,5	10unid.	19,90€
SL-AMMM-14NI	M32X1,5	M63X1,5	10unid.	23,90€
SL-AMMM-15NI	M40X1,5	M50X1,5	10unid.	15,90€
SL-AMMM-16NI	M40X1,5	M63X1,5	10unid.	21,90€
SL-AMMM-17NI	M50X1,5	M63X1,5	10unid.	20,90€

## Ampliação Metálica PG/PG

Código	Med.Ext. a)	Med.Int. b)	Qty Min. Venda	P.U.€
SL-AMPP-01NI	PG 7	PG 9	10unid.	1,80€
SL-AMPP-02NI	PG 9	PG 11	10unid.	1,80€
SL-AMPP-04NI	PG 9	PG 16	10unid.	2,70€
SL-AMPP-06NI	PG 11	PG 13,5	10unid.	2,80€
SL-AMPP-08NI	PG 13,5	PG 16	10unid.	2,95€
SL-AMPP-10NI	PG 16	PG 21	10unid.	4,95€
SL-AMPP-12NI	PG 21	PG 29	10unid.	8,60€
SL-AMPP-14NI	PG 29	PG 36	10unid.	15,90€
SL-AMPP-16NI	PG 36	PG 42	10unid.	22,95€
SL-AMPP-18NI	PG 42	PG 48	10unid.	29,95€

## Adaptador Metálico / PG

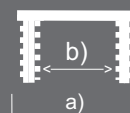

Código	Med.Ext. a)	Med.Int. b)	Qty Min. Venda	P.U.€
SL-AMMP-01NI	M12X1,5	PG 7X1,5	10unid.	1,95€
SL-AMMP-02NI	M16X1,5	PG 9X1,5	10unid.	2,80€
SL-AMMP-03NI	M16X1,5	PG 11X1,5	10unid.	2,95€
SL-AMMP-04NI	M16X1,5	PG 13,5X1,5	10unid.	3,50€
SL-AMMP-05NI	M20X1,5	PG 11X1,5	10unid.	3,60€
SL-AMMP-06NI	M20X1,5	PG 13,5X1,5	10unid.	3,60€
SL-AMMP-07NI	M20X1,5	PG 16X1,5	10unid.	3,70€
SL-AMMP-08NI	M20X1,5	PG 21X1,5	10unid.	4,95€
SL-AMMP-09NI	M25X1,5	PG 13,5X1,5	10unid.	4,95€
SL-AMMP-10NI	M25X1,5	PG 16X1,5	10unid.	4,95€
SL-AMMP-11NI	M25X1,5	PG 21X1,5	10unid.	5,60€
SL-AMMP-12NI	M25X1,5	PG 29X1,5	10unid.	8,90€
SL-AMMP-13NI	M32X1,5	PG 21X1,5	10unid.	8,95€
SL-AMMP-14NI	M32X1,5	PG 29X1,5	10unid.	8,95€
SL-AMMP-15NI	M40X1,5	PG 21X1,5	10unid.	13,00€
SL-AMMP-16NI	M40X1,5	PG 29X1,5	10unid.	13,10€
SL-AMMP-17NI	M50X1,5	PG 36X1,5	10unid.	25,00€
SL-AMMP-18NI	M50X1,5	PG 42X1,5	10unid.	25,00€
SL-AMMP-19NI	M63X1,5	PG 42X1,5	10unid.	37,00€
SL-AMMP-20NI	M63X1,5	PG 48X1,5	10unid.	38,00€





## Tubo Flexível PVC

Quantidade Mínima Venda, Rolo completo

Código	PG				Mat. Prima	Cor	P.U.mt/€
TPVC-PG7CZ	PG 7	13,3mm	10mm	30mts	PVC	Cinza	0,70€/mt
TPVC-PG7PT	PG 7	13,3mm	10mm	30mts	PVC	Preto	0,70€/mt
TPVC-PG7AN	PG 7	13,3mm	10mm	30mts	PVC	Antracite	0,70€/mt
TPVC-PG9CZ	PG 9	16mm	12mm	30mts	PVC	Cinza	0,90€/mt
TPVC-PG9PT	PG 9	16mm	12mm	30mts	PVC	Preto	0,90€/mt
TPVC-PG9AN	PG 9	16mm	12mm	30mts	PVC	Antracite	0,90€/mt
TPVC-PG11CZ	PG 11	20mm	16mm	30mts	PVC	Cinza	1,20€/mt
TPVC-PG11PT	PG 11	20mm	16mm	30mts	PVC	Preto	1,20€/mt
TPVC-PG11AN	PG 11	20mm	16mm	30mts	PVC	Antracite	1,20€/mt
TPVC-PG13CZ	PG 13	21,2mm	18mm	30mts	PVC	Cinza	1,35€/mt
TPVC-PG13PT	PG 13	21,2mm	18mm	30mts	PVC	Preto	1,35€/mt
TPVC-PG13AN	PG 13	21,2mm	18mm	30mts	PVC	Antracite	1,35€/mt
TPVC-PG16CZ	PG 16	22,5mm	20mm	30mts	PVC	Cinza	1,67€/mt
TPVC-PG16PT	PG 16	22,5mm	20mm	30mts	PVC	Preto	1,67€/mt
TPVC-PG16AN	PG 16	22,5mm	20mm	30mts	PVC	Antracite	1,67€/mt
TPVC-PG21CZ	PG 21	28,5mm	25mm	30mts	PVC	Cinza	2,05€/mt
TPVC-PG21PT	PG 21	28,5mm	25mm	30mts	PVC	Preto	2,05€/mt
TPVC-PG21AN	PG 21	28,5mm	25mm	30mts	PVC	Antracite	2,05€/mt
TPVC-PG29CZ	PG 29	37mm	32mm	30mts	PVC	Cinza	2,78€/mt
TPVC-PG29PT	PG 29	37mm	32mm	30mts	PVC	Preto	2,78€/mt
TPVC-PG29AN	PG 29	37mm	32mm	30mts	PVC	Antracite	2,78€/mt
TPVC-PG36CZ	PG 36	47mm	40mm	30mts	PVC	Cinza	3,95€/mt
TPVC-PG36PT	PG 36	47mm	40mm	30mts	PVC	Preto	3,95€/mt
TPVC-PG36AN	PG 36	47mm	40mm	30mts	PVC	Antracite	3,95€/mt
TPVC-PG48CZ	PG 48	55,5mm	50mm	30mts	PVC	Cinza	5,70€/mt
TPVC-PG48PT	PG 48	55,5mm	50mm	30mts	PVC	Preto	5,70€/mt
TPVC-PG48AN	PG 48	55,5mm	50mm	30mts	PVC	Antracite	5,70€/mt



## Bucim PG para Tubo PVC

Código	Rosca	Mat. Prima	Cor	Para Tubo	Qt/Caixa	P.U./€
BTPVC-PG9-CZ	M 16	PVC	Cinza Ral 7035	TPVC-PG9	1200pcs	1,30€
BTPVC-PG11-CZ	M 20	PVC	Cinza Ral 7035	TPVC-PG11	800pcs	1,55€
BTPVC-PG16-CZ	M 25	PVC	Cinza Ral 7035	TPVC-PG16	800pcs	2,00€
BTPVC-PG21-CZ	M 32	PVC	Cinza Ral 7035	TPVC-PG21	500pcs	2,57€
BTPVC-PG29-CZ	M 40	PVC	Cinza Ral 7035	TPVC-PG29	160pcs	2,85€

## Tubo Flexível PA 6

-40 a 120°C / IP68

Alta resistência ao Impacto e UV

Auto-extinguível, Livre Halogêneos

Resistência a óleos, Gasolina, ácidos e dissolventes

Quantidade Mínima Venda, Rolo completo

Código	PG					Mat. Prima	Cor	Rolo	P.U./mt/€
TPA6-PG7-PT	PG 7	10mm	6,5mm	15mm	50mts	PA 6	Preto	50mts	0,62€/mt
TPA6-PG9-PT	PG 9	13mm	10mm	20mm	50mts	PA 6	Preto	50mts	0,69€/mt
TPA6-PG11-PT	PG 11	16mm	12mm	30mm	50mts	PA 6	Preto	50mts	0,93€/mt
TPA6-PG13-PT	PG 13,5	18,5mm	14mm	40mm	50mts	PA 6	Preto	50mts	1,24€/mt
TPA6-P16-PT	PG 16	21mm	17mm	45mm	50mts	PA 6	Preto	50mts	1,31€/mt
TPA6-PG21-PT	PG 21	28,7mm	23mm	55mm	50mts	PA 6	Preto	50mts	1,95€/mt
TPA6-PG29-PT	PG 29	34,5mm	29mm	65mm	25mts	PA 6	Preto	25mts	2,45€/mt
TPA6-PG36-PT	PG 36	48,5mm	36mm	80mm	25mts	PA 6	Preto	25mts	3,15€/mt
TPA6-PG48-PT	PG 48	54,5mm	48mm	95mm	25mts	PA 6	Preto	25mts	5,30€/mt



## Tubo Flexível PA 6 ( Aberto )

Quantidade Mínima Venda, Rolo completo

Código	PG					Mat. Prima	Cor	Rolo	P.U./mt/€
TPA6-PG7-PT-A	PG 7	10mm	6,5mm	15mm	50mts	PA 6	Preto	50mts	0,90€/mt
TPA6-PG9-PT-A	PG 9	13mm	10mm	20mm	50mts	PA 6	Preto	50mts	0,95€/mt
TPA6-PG11-PT-A	PG 11	16mm	12mm	30mm	50mts	PA 6	Preto	50mts	1,10€/mt
TPA6-PG13-PT-A	PG 13,5	18,5mm	14mm	40mm	50mts	PA 6	Preto	50mts	1,64€/mt
TPA6-PG16-PT-A	PG 16	21mm	17mm	45mm	50mts	PA 6	Preto	50mts	1,75€/mt
TPA6-PG21-PT-A	PG 21	28,7mm	23mm	55mm	50mts	PA 6	Preto	50mts	2,86€/mt
TPA6-PG29-PT-A	PG 29	34,5mm	29mm	65mm	25mts	PA 6	Preto	25mts	3,65€/mt
TPA6-PG36-PT-A	PG 36	48,5mm	36mm	80mm	25mts	PA 6	Preto	25mts	5,10€/mt
TPA6-PG48-PT-A	PG 48	54,5mm	48mm	95mm	25mts	PA 6	Preto	25mts	6,94€/mt



## Bucim PG para Tubo PA6

Código	Rosca			Rosca ↓	Bucim ↓	Mat. Prima	Cor	Para tubo	Qty Min. Venda	P.U./€
BTPA6-PG7-PT	PG 7	17mm	13mm	11,5mm	34,5mm	PA 6	Preto	TPA6-PG7	10pcs	0,74€
BTPA6-PG9-PT	PG 9	20mm	16mm	11,5mm	36,5mm	PA 6	Preto	TPA6-PG9	10pcs	0,74€
BTPA6-PG11-PT	PG 11	23mm	19mm	12mm	39,50	PA 6	Preto	TPA6-PG11	10pcs	0,74€
BTPA6-PG13-PT	PG 13,5	26mm	21mm	13mm	42mm	PA 6	Preto	TPA6-PG13,5	10pcs	1,16€
BTPA6-PG16-PT	PG 16	29,5mm	23mm	13mm	45mm	PA 6	Preto	TPA6-P16	10pcs	1,16€
BTPA6-PG21-PT	PG 21	37mm	29mm	13mm	47mm	PA 6	Preto	TPA6-PG21	10pcs	1,45€
BTPA6-PG29-PT	PG 29	44mm	37mm	15mm	51mm	PA 6	Preto	TPA6-PG29	5pcs	2,30€
BTPA6-PG36-PT	PG 36	52mm	47mm	15mm	54mm	PA 6	Preto	TPA6-PG36	5pcs	3,95€
BTPA6-PG48-PT	PG 48	64mm	48mm	16mm	55mm	PA 6	Preto	TPA6-PG48	5pcs	4,90€



## Bucim Métrico para Tubo PA6

Código	Rosca			Rosca ↓	Bucim ↓	Mat. Prima	Cor	Para tubo	Qty Min. Venda	P.U./€
BTPA6-M12-PT	M12	17mm	12mm	11,5mm	34,5mm	PA 6	Preto	TPA6-PG7	10pcs	0,95€
BTPA6-M16-PT	M16	20mm	16mm	11,5mm	36,5mm	PA 6	Preto	TPA6-PG9	10pcs	0,95€
BTPA6-M16-S-PT	M16	20mm	16mm	11,5mm	36,50	PA 6	Preto	TPA6-PG11	10pcs	1,10€
BTPA6-M20-PT	M20	26mm	20mm	10mm	39,5mm	PA 6	Preto	TPA6-PG13,5	10pcs	1,30€
BTPA6-M20-S-PT	M20	29,5mm	20mm	13mm	45mm	PA 6	Preto	TPA6-P16	10pcs	1,35€
BTPA6-M25-PT	M25	37mm	25mm	13mm	45mm	PA 6	Preto	TPA6-PG21	10pcs	1,80€
BTPA6-M32-PT	M32	44mm	32mm	13mm	47mm	PA 6	Preto	TPA6-PG29	10pcs	2,35€
BTPA6-M40-PT	M40	52mm	40mm	15mm	51mm	PA 6	Preto	TPA6-PG36	5pcs	2,90€
BTPA6-M50-PT	M50	64mm	50mm	15mm	54mm	PA 6	Preto	TPA6-PG48	5pcs	5,30€
BTPA6-M63-PT	M63	64mm	63mm	16mm	55mm	PA 6	Preto	TPA6-PG48	5pcs	8,95€



## Abraçadeira para Tubo PA6

Código		Mat. Prima	Cor	Para tubo	Qty Min. Venda	P.U./€
ATPA6-M12	10mm	PA 6	Preto	TPA6-PG7	10pcs	0,47€
ATPA6-M16	13mm	PA 6	Preto	TPA6-PG9	10pcs	0,47€
ATPA6-M16-S	16mm	PA 6	Preto	TPA6-PG11	10pcs	0,57€
ATPA6-M20	18,5mm	PA 6	Preto	TPA6-PG13,5	10pcs	0,84€
ATPA6-M20-S	21mm	PA 6	Preto	TPA6-P16	10pcs	0,84€
ATPA6-M25	28,7mm	PA 6	Preto	TPA6-PG21	10pcs	1,15€
ATPA6-M32	34mm	PA 6	Preto	TPA6-PG29	5pcs	1,55€
ATPA6-M40	42mm	PA 6	Preto	TPA6-PG36	5pcs	1,80€
ATPA6-M50	54mm	PA 6	Preto	TPA6-PG48	5pcs	3,10€



## Tubo Flexível Galvanizado revestido PVC



Código	"					Acabamento	P.U./mt
MFM-01-014	1/4"	14mm	10mm	40mm	50mts	Galvanizado / PVC / Preto	1,55€/mt
MFM-01-038	3/8"	17mm	13mm	45mm	50mts	Galvanizado / PVC / Preto	1,75€/mt
MFM-01-012	1/2"	21mm	16mm	70mm	50mts	Galvanizado / PVC / Preto	1,90€/mt
MFM-01-034	3/4"	26mm	21mm	70mm	25mts	Galvanizado / PVC / Preto	2,15€/mt
MFM-01-100	1"	32mm	26mm	95mm	50mts	Galvanizado / PVC / Preto	2,70€/mt
MFM-01-114	1.1/4"	41mm	35mm	110mm	25mts	Galvanizado / PVC / Preto	3,65€/mt
MFM-01-112	1.1/2"	47mm	40mm	120mm	25mts	Galvanizado / PVC / Preto	5,30€/mt
MFM-01-200	2"	59mm	52mm	180mm	25mts	Galvanizado / PVC / Cinza	6,95€/mt
MFM-01-212	2.1/2"	72mm	63mm	200mm	25mts	Galvanizado / PVC / Cinza	9,25€/mt
MFM-01-300	3"	88mm	78mm	280mm	10mts	Galvanizado / PVC / Cinza	55,00€/mt
MFM-01-400	4"	112mm	102mm	350mm	10mts	Galvanizado / PVC / Cinza	69,50€/mt

## Bucins Para Tubo Flexível Galvanizado revestido PVC



Código	"	Acabamento	P.U./€
MFM-03-014	1/4"	Galvanizado	8,10€
MFM-03-038	3/8"	Galvanizado	8,45€
MFM-03-012	1/2"	Galvanizado	10,50€
MFM-03-034	3/4"	Galvanizado	10,95€
MFM-03-100	1"	Galvanizado	12,95€
MFM-03-114	1.1/4"	Galvanizado	24,90€
MFM-03-112	1.1/2"	Galvanizado	36,90€
MFM-03-200	2"	Galvanizado	46,50€
MFM-03-212	2.1/2"	Galvanizado	74,00€
MFM-03-300	3"	Galvanizado	126,00€
MFM-03-400	4"	Galvanizado	238,00€

## Topo Para Tubo Flexível Galvanizado revestido PVC



Código	"	Acabamento	P.U./€
MFM-02-014	1/4"	Galvanizado / PVC	1,10€
MFM-02-038	3/8"	Galvanizado / PVC	1,50€
MFM-02-012	1/2"	Galvanizado / PVC	1,60€
MFM-02-034	3/4"	Galvanizado / PVC	1,80€
MFM-02-100	1"	Galvanizado / PVC	2,60€
MFM-02-114	1.1/4"	Galvanizado / PVC	3,70€
MFM-02-112	1.1/2"	Galvanizado / PVC	4,60€
MFM-02-200	2"	Galvanizado / PVC	7,60€
MFM-02-212	2.1/2"	Galvanizado / PVC	13,80€
MFM-02-300	3"	Galvanizado / PVC	25,90€
MFM-02-400	4"	Galvanizado / PVC	31,00€

## Manga Expansível Auto Extinguível PA



Código	Cor	Diâmetro	Quantidade Min. Venda	P.U./mt
MEPA6-07CZ	Cinza	3x7mm	100mts	0,32€
MEPA6-12CZ	Cinza	8x12mm	100mts	0,45€
MEPA6-16CZ	Cinza	5x16mm	50mts	0,54€
MEPA6-20CZ	Cinza	8x20mm	50mts	0,64€
MEPA6-25CZ	Cinza	10x25mm	50mts	1,00€
MEPA6-32CZ	Cinza	13x32mm	25mts	1,25€
MEPA6-38CZ	Cinza	16x38mm	25mts	1,45€
MEPA6-44CZ	Cinza	19x44mm	25mts	1,45€
MEPA6-07PT	Preta	3x7mm	100mts	0,32€
MEPA6-12PT	Preta	8x12mm	100mts	0,45€
MEPA6-16PT	Preta	5x16mm	50mts	0,54€
MEPA6-20PT	Preta	8x20mm	50mts	0,64€
MEPA6-25PT	Preta	10x25mm	50mts	1,00€
MEPA6-32PT	Preta	13x32mm	25mts	1,25€
MEPA6-38PT	Preta	16x38mm	25mts	1,45€
MEPA6-44PT	Preta	19x44mm	25mts	1,45€

## Fita Espiral



Novos  
Produtos

Código	Descrição	Quantidade Min. Venda	P.U./mt
SL-FE-06NA	Fita Espiral 4-6mm Natural	10mts	0,28€
SL-FE-08NA	Fita Espiral 6-8mm Natural	10mts	0,42€
SL-FE-10NA	Fita Espiral 7,5-10mm Natural	10mts	0,54€
SL-FE-12NA	Fita Espiral 9-12mm Natural	10mts	0,65€
SL-FE-15NA	Fita Espiral 13-15mm Natural	10mts	1,00€
SL-FE-19NA	Fita Espiral 16-19mm Natural	10mts	1,50€
SL-FE-24NA	Fita Espiral 21-24mm Natural	10mts	2,50€
SL-FE-06PT	Fita Espiral 4-6mm Preta	10mts	0,28€
SL-FE-08PT	Fita Espiral 6-8mm Preta	10mts	0,42€
SL-FE-10PT	Fita Espiral 7,5-10mm Preta	10mts	0,54€
SL-FE-12PT	Fita Espiral 9-12mm Preta	10mts	0,65€
SL-FE-15PT	Fita Espiral 13-15mm Preta	10mts	1,00€
SL-FE-19PT	Fita Espiral 16-19mm Preta	10mts	1,50€
SL-FE-24PT	Fita Espiral 21-24mm Preta	10mts	2,50€

## Tubo D'Aço Galvanizado

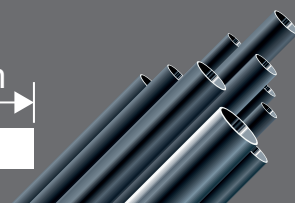
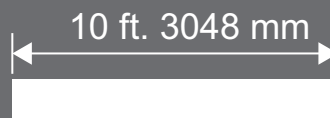
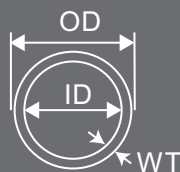

Código	"					Acabamento	P.U./mt
TA-01-012	1/2"	17.93mm	15.80mm	1.07mm	3048mm	Galvanizado	4,50€/mt
TA-01-034	3/4"	23.42mm	20.93mm	1.25mm	3048mm	Galvanizado	5,25€/mt
TA-01-100	1"	29.54mm	26.64mm	1.45mm	3048mm	Galvanizado	6,60€/mt
TA-01-114	1.1/4"	38.95mm	35.05mm	1.65mm	3048mm	Galvanizado	9,90€/mt
TA-01-112	1.1/2"	44.20mm	40.89mm	1.65mm	3048mm	Galvanizado	13,50€/mt
TA-01-200	2"	55.80mm	52.50mm	1.65mm	3048mm	Galvanizado	19,80€/mt
TA-01-212	2.1/2"	73.03mm	69.37mm	1.83mm	3048mm	Galvanizado	22,80€/mt

## União para Tubo D'Aço Galvanizado



Código	"	A	B	Acabamento	P.U./€
TA-02-012	1/2"	18,50mm	37,00mm	Galvanizado	2,70€
TA-02-034	3/4"	24,00mm	46,00mm	Galvanizado	2,90€
TA-02-100	1"	30,00mm	50,00mm	Galvanizado	3,60€
TA-02-114	1.1/4"	39,50mm	61,00mm	Galvanizado	7,60€
TA-02-112	1.1/2"	45,00mm	69,00mm	Galvanizado	8,90€
TA-02-200	2"	56,50mm	82,00mm	Galvanizado	13,90€
TA-02-212	2.1/2"	74,00mm	102,00mm	Galvanizado	22,00€

## Curva 90° para Tubo D'Aço Galvanizado

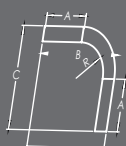

Código	"	R	A	B	C	Acabamento	P.U./€
TA-03-012	1/2"	102mm	38mm	149mm	149mm	Galvanizado	5,90€
TA-03-034	3/4"	114mm	38mm	178mm	178mm	Galvanizado	6,20€
TA-03-100	1"	146mm	48mm	222mm	222mm	Galvanizado	6,80€
TA-03-114	1.1/4"	184mm	51mm	257mm	257mm	Galvanizado	9,90€
TA-03-112	1.1/2"	210mm	51mm	298mm	298mm	Galvanizado	14,580€
TA-03-200	2"	241mm	51mm	356mm	356mm	Galvanizado	28,90€
TA-03-212	2.1/2"	267mm	76mm	413mm	413mm	Galvanizado	37,40€

## Topo proteção para tubo D'Aço Galvanizado

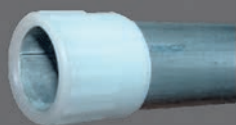

Código	"	Acabamento	P.U./€
TA-04-012	1/2"	PVC	1,35€
TA-04-034	3/4"	PVC	1,60€
TA-04-100	1"	PVC	2,55€
TA-04-114	1.1/4"	PVC	3,70€
TA-04-112	1.1/2"	PVC	4,25€
TA-04-200	2"	PVC	5,90€
TA-04-212	2.1/2"	PVC	11,70€

## Curva Tubos para tubo D'Aço Galvanizado



Código	"	Curva Tubos	P.U./€
TA-05-012	1/2"	PVC	155,00€
TA-05-034	3/4"	PVC	210,00€
TA-05-100	1"	PVC	285,00

Abraçadeira Serrilha

Material: Nylon PA6.6

Flamabilidade: 94V-2

Temperatura trabalho: -30 / 80° C

Novos  
Produtos

Código	Descrição	Comprimento	Largura	Cor	Quantidade Min.Venda	Preço Unitário
SL-ABS-100X2,5-BR	Abraçadeira Serrilha	100mm	2,5mm	Branca	100 Unid.	0,0494€
SL-ABS-100X2,5-PT	Abraçadeira Serrilha	100mm	2,5mm	Preta	100 Unid.	0,0494€
SL-ABS-150X2,5-BR	Abraçadeira Serrilha	150mm	2,5mm	Branca	100 Unid.	0,0088€
SL-ABS-150X2,5-PT	Abraçadeira Serrilha	150mm	2,5mm	Preta	100 Unid.	0,0088€
SL-ABS-150X3,6-BR	Abraçadeira Serrilha	150mm	3,6mm	Branca	100 Unid.	0,0133€
SL-ABS-150X3,6-PT	Abraçadeira Serrilha	150mm	3,6mm	Preta	100 Unid.	0,0133€
SL-ABS-150X4,8-BR	Abraçadeira Serrilha	150mm	4,8mm	Branca	100 Unid.	0,0235€
SL-ABS-150X4,8-PT	Abraçadeira Serrilha	150mm	4,8mm	Preta	100 Unid.	0,0235€
SL-ABS-200X2,5-BR	Abraçadeira Serrilha	200mm	2,5mm	Branca	100 Unid.	0,0111€
SL-ABS-200X2,5-PT	Abraçadeira Serrilha	200mm	2,5mm	Preta	100 Unid.	0,0111€
SL-ABS-200X3,6-BR	Abraçadeira Serrilha	200mm	3,6mm	Branca	100 Unid.	0,0160€
SL-ABS-200X3,6-PT	Abraçadeira Serrilha	200mm	3,6mm	Preta	100 Unid.	0,0160€
SL-ABS-200X4,8-BR	Abraçadeira Serrilha	200mm	4,8mm	Branca	100 Unid.	0,0228€
SL-ABS-200X4,8-PT	Abraçadeira Serrilha	200mm	4,8mm	Preta	100 Unid.	0,0228€
SL-ABS-250X3,6-BR	Abraçadeira Serrilha	250mm	3,6mm	Branca	100 Unid.	0,0210€
SL-ABS-250X3,6-PT	Abraçadeira Serrilha	250mm	3,6mm	Preta	100 Unid.	0,0210€
SL-ABS-250X4,8-BR	Abraçadeira Serrilha	250mm	4,8mm	Branca	100 Unid.	0,0277€
SL-ABS-250X4,8-PT	Abraçadeira Serrilha	250mm	4,8mm	Preta	100 Unid.	0,0277€
SL-ABS-250X7,6-BR	Abraçadeira Serrilha	250mm	7,6mm	Branca	100 Unid.	0,0599€
SL-ABS-250X7,6-PT	Abraçadeira Serrilha	250mm	7,6mm	Preta	100 Unid.	0,0599€
SL-ABS-300X3,6-BR	Abraçadeira Serrilha	300mm	3,6mm	Branca	100 Unid.	0,0270€
SL-ABS-300X3,6-PT	Abraçadeira Serrilha	300mm	3,6mm	Preta	100 Unid.	0,0270€
SL-ABS-300X4,8-BR	Abraçadeira Serrilha	300mm	4,8mm	Branca	100 Unid.	0,0370€
SL-ABS-300X4,8-PT	Abraçadeira Serrilha	300mm	4,8mm	Preta	100 Unid.	0,0370€
SL-ABS-300X7,6-BR	Abraçadeira Serrilha	300mm	7,6mm	Branca	100 Unid.	0,0733€
SL-ABS-300X7,6-PT	Abraçadeira Serrilha	300mm	7,6mm	Preta	100 Unid.	0,0733€
SL-ABS-370X3,6-BR	Abraçadeira Serrilha	370mm	3,6mm	Branca	100 Unid.	0,0355€
SL-ABS-370X3,6-PT	Abraçadeira Serrilha	370mm	3,6mm	Preta	100 Unid.	0,0355€
SL-ABS-380X4,8-BR	Abraçadeira Serrilha	380mm	4,8mm	Branca	100 Unid.	0,0475€
SL-ABS-380X4,8-PT	Abraçadeira Serrilha	380mm	4,8mm	Preta	100 Unid.	0,0475€
SL-ABS-370X7,6-BR	Abraçadeira Serrilha	370mm	7,6mm	Branca	100 Unid.	0,0932€
SL-ABS-370X7,6-PT	Abraçadeira Serrilha	370mm	7,6mm	Preta	100 Unid.	0,0932€
SL-ABS-450X4,8-BR	Abraçadeira Serrilha	450mm	4,8mm	Branca	100 Unid.	0,0565€
SL-ABS-450X4,8-PT	Abraçadeira Serrilha	450mm	4,8mm	Preta	100 Unid.	0,0565€
SL-ABS-450X7,6-BR	Abraçadeira Serrilha	380mm	7,6mm	Branca	100 Unid.	0,1089€
SL-ABS-450X7,6-PT	Abraçadeira Serrilha	380mm	7,6mm	Preta	100 Unid.	0,1089€
SL-ABS-550X7,6-BR	Abraçadeira Serrilha	550mm	7,6mm	Branca	100 Unid.	0,1511€
SL-ABS-550X7,6-PT	Abraçadeira Serrilha	550mm	7,6mm	Preta	100 Unid.	0,1511€
SL-ABS-500X8,5-BR	Abraçadeira Serrilha	500mm	8,5mm	Branca	100 Unid.	0,1250€
SL-ABS-500X8,5-PT	Abraçadeira Serrilha	500mm	8,5mm	Preta	100 Unid.	0,1250€
SL-ABS-610X9,0-BR	Abraçadeira Serrilha	610mm	9,0mm	Branca	100 Unid.	0,2067€
SL-ABS-610X9,0-PT	Abraçadeira Serrilha	610mm	9,0mm	Preta	100 Unid.	0,2067€
SL-ABS-750X9,0-BR	Abraçadeira Serrilha	750mm	9,0mm	Branca	100 Unid.	0,2592€
SL-ABS-750X9,0-PT	Abraçadeira Serrilha	750mm	9,0mm	Preta	100 Unid.	0,2592€
SL-ABS-920X9,0-BR	Abraçadeira Serrilha	920mm	9,0mm	Branca	100 Unid.	0,3073€
SL-ABS-920X9,0-PT	Abraçadeira Serrilha	920mm	9,0mm	Preta	100 Unid.	0,3073€
SL-ABS-760X12,6-BR	Abraçadeira Serrilha	760mm	12,6mm	Branca	100 Unid.	0,3890€
SL-ABS-760X12,6-PT	Abraçadeira Serrilha	760mm	12,6mm	Preta	100 Unid.	0,3890€
SL-ABS1020X9,0-BR	Abraçadeira Serrilha	1020mm	9,0mm	Branca	100 Unid.	0,3892€
SL-ABS1020X9,0-PT	Abraçadeira Serrilha	1020mm	9,0mm	Preta	100 Unid.	0,3892€

Novas medidas e novos códigos, até esgotar stock antigos, serão enviadas as medidas equivalentes às medidas e códigos actuais

# Abraçadeiras de Serrilha

Abraçadeira Serrilha com Etiqueta

Material: Nylon PA6.6

Flamabilidade: 94V-2

Temperatura trabalho: -30 / 80° C



Novos  
Produtos

Código	Descrição	Dimensão	Cor	Quantidade Min.Venda	Preço Unitário
SL-ASI-100X2,5-BR	Abraçadeira Serrilha de Identificação	100x2,5mm	Branca	100 Unid.	0,0400€
SL-ASI-150X3,6-BR	Abraçadeira Serrilha de Identificação	150x3,6mm	Branca	100 Unid.	0,0480€
SL-ASI-200X3,6-BR	Abraçadeira Serrilha de Identificação	200x3,6mm	Branca	100 Unid.	0,0900€

Abraçadeira Serrilha Reutilizável

Material: Nylon PA6.6

Flamabilidade: 94V-2

Temperatura trabalho: -30 / 80° C



Novos  
Produtos

Código	Descrição	Dimensão	Cor	Quantidade Min.Venda	Preço Unitário
SL-ASR150X7,6-BR	Abraçadeira Serrilha Reutilizável	150x7,6mm	Branca	100 Unid.	0,0390€
SL-ASR150X7,6-PT	Abraçadeira Serrilha Reutilizável	150x7,6mm	Preta	100 Unid.	0,0390€
SL-ASR200X7,6-BR	Abraçadeira Serrilha Reutilizável	200x7,6mm	Branca	100 Unid.	0,0520€
SL-ASR200X7,6-PT	Abraçadeira Serrilha Reutilizável	200x7,6mm	Preta	100 Unid.	0,0520€
SL-ASR250X7,6-BR	Abraçadeira Serrilha Reutilizável	250x7,6mm	Branca	100 Unid.	0,0600€
SL-ASR250X7,6-PT	Abraçadeira Serrilha Reutilizável	250x7,6mm	Preta	100 Unid.	0,0600€
SL-ASR300X7,6-BR	Abraçadeira Serrilha Reutilizável	300x7,6mm	Branca	100 Unid.	0,0710€
SL-ASR300X7,6-PT	Abraçadeira Serrilha Reutilizável	300x7,6mm	Preta	100 Unid.	0,0710€
SL-ASR350X7,6-BR	Abraçadeira Serrilha Reutilizável	350x7,6mm	Branca	100 Unid.	0,0895€
SL-ASR350X7,6-PT	Abraçadeira Serrilha Reutilizável	350x7,6mm	Preta	100 Unid.	0,0895€

Abraçadeira Redonda com Prego

Material: P.P.

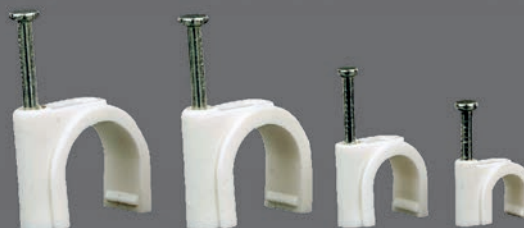

Novos  
Produtos

Código	Descrição	Ø	Altura	Cor	Quantidade Min.Venda	Preço Unitário
SL-ABP-4MM-BR	Abraçadeira com Prego D'Áço	4mm	5,3mm	Branca	100 Unid.	0,0160€
SL-ABP-5MM-BR	Abraçadeira com Prego D'Áço	5mm	6,5mm	Branca	100 Unid.	0,0170€
SL-ABP-6MM-BR	Abraçadeira com Prego D'Áço	6mm	8,1mm	Branca	100 Unid.	0,0180€
SL-ABP-7MM-BR	Abraçadeira com Prego D'Áço	7mm	8,7mm	Branca	100 Unid.	0,0190€
SL-ABP-8MM-BR	Abraçadeira com Prego D'Áço	8mm	9,6mm	Branca	100 Unid.	0,0210€
SL-ABP-9MM-BR	Abraçadeira com Prego D'Áço	9mm	10,7mm	Branca	100 Unid.	0,0220€
SL-ABP-10MM-BR	Abraçadeira com Prego D'Áço	10mm	11,7mm	Branca	100 Unid.	0,0250€
SL-ABP-12MM-BR	Abraçadeira com Prego D'Áço	12mm	12,8mm	Branca	100 Unid.	0,0270€
SL-ABP-14MM-BR	Abraçadeira com Prego D'Áço	14mm	14,9mm	Branca	100 Unid.	0,0450€
SL-ABP-16MM-BR	Abraçadeira com Prego D'Áço	16mm	16,9mm	Branca	100 Unid.	0,0620€
SL-ABP-20MM-BR	Abraçadeira com Prego D'Áço	20mm	23,5mm	Branca	50 Unid.	0,0670€
SL-ABP-22MM-BR	Abraçadeira com Prego D'Áço	22mm	25mm	Branca	50 Unid.	0,0730€
SL-ABP-25MM-BR	Abraçadeira com Prego D'Áço	25mm	27,7mm	Branca	50 Unid.	0,0840€
SL-ABP-32MM-BR	Abraçadeira com Prego D'Áço	32mm	35mm	Branca	50 Unid.	0,1710€

### Abraçadeira Tipo R

Material: Nylon PA6.6

Flamabilidade: 94V-2

Temperatura trabalho: -30 / 80° C

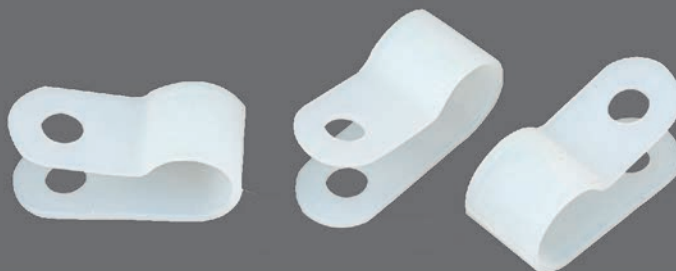

Novos  
Produtos

Código	Descrição	Dimensão	Cor	Quantidade Min.Venda	Preço Unitário
SL-ABR-3,2R-BR	Abraçadeira Tipo R	3,2mm	Branca	100 Unid.	0,020€
SL-ABR-4,8R-BR	Abraçadeira Tipo R	4,8mm2	Branca	100 Unid.	0,021€
SL-ABR-6,35R-BR	Abraçadeira Tipo R	6,35mm2	Branca	100 Unid.	0,025€
SL-ABR-7,9R-BR	Abraçadeira Tipo R	7,9mm2	Branca	100 Unid.	0,030€
SL-ABR-9,5R-BR	Abraçadeira Tipo R	9,5mm2	Branca	100 Unid.	0,035€
SL-ABR-12,7R-BR	Abraçadeira Tipo R	12,7mm2	Branca	100 Unid.	0,040€
SL-ABR-15,8R-BR	Abraçadeira Tipo R	15,8mm2	Branca	100 Unid.	0,065€
SL-ABR-19,4R-BR	Abraçadeira Tipo R	19,4mm2	Branca	100 Unid.	0,160€
SL-ABR-25,4R-BR	Abraçadeira Tipo R	25,4mm2	Branca	100 Unid.	0,300€
SL-ABR-27,5R-BR	Abraçadeira Tipo R	27,5mm2	Branca	100 Unid.	0,350€

### Base para Abraçadeira Serrilha com Base Autocolante

Material: Nylon PA6.6

Flamabilidade: 94V-2

Temperatura trabalho: -30 / 80° C

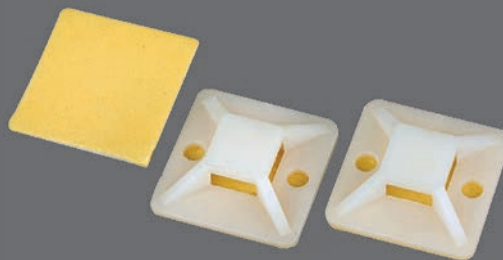

Novos  
Produtos

Código	Descrição	Cor	Quantidade Min.Venda	Preço Unitário
SL-BASE-20X20-BR	Base Adesiva 20x20mm para Abraç. Serrilha até 5mm	Branca	100 Unid.	0,029€
SL-BASE-30X30-BR	Base Adesiva 30x30mm para Abraç. Serrilha até 6,4mm	Branca	100 Unid.	0,056€

### Base para Abraçadeira Serrilha Fixação por Parafuso

Material: Nylon PA6.6

Flamabilidade: 94V-2

Temperatura trabalho: -30 / 80° C

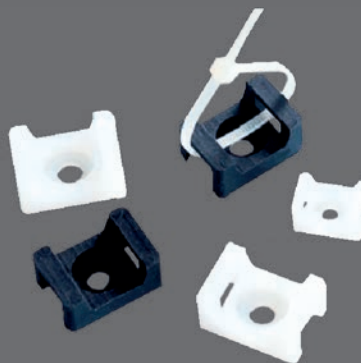

Novos  
Produtos

Código	Descrição	Cor	Quantidade Min.Venda	Preço Unitário
SL-BASE-P0-BR	Base p/Abraç. Serrilha até 5mm Fix. por Parafuso 9x7mm	Branca	100 Unid.	0,035€
SL-BASE-P1-BR	Base p/Abraç. Serrilha até 7mm Fix. por Parafuso 15x10mm	Branca	100 Unid.	0,036€
SL-BASE-P2-BR	Base p/Abraç. Serrilha até 9mm Fix. por Parafuso 22x15mm	Branca	100 Unid.	0,070€
SL-BASE-P0-PT	Base p/Abraç. Serrilha até 5mm Fix. por Parafuso 9x7mm	Preta	100 Unid.	0,035€
SL-BASE-P1-PT	Base p/Abraç. Serrilha até 7mm Fix. por Parafuso 15x10mm	Preta	100 Unid.	0,036€
SL-BASE-P2-PT	Base p/Abraç. Serrilha até 9mm Fix. por Parafuso 22x15mm	Preta	100 Unid.	0,070€



# Acessórios

Marcadores para fios, Numéricos / Alfabéticos

Material: PVC

Alta Resistência a Óleos e Erosão

Temperatura trabalho: -30 / 85° C

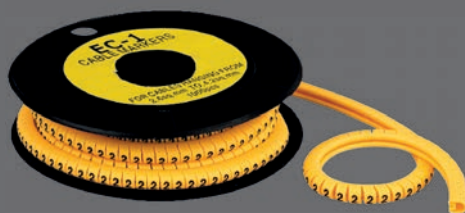

Novos  
Podutos

Código	Descrição	Qt./ Mín.Venda Rolo 1000 Uni.	Preço Unitário	Código	Descrição	Qt./ Mín.Venda Rolo 1000 Uni.	Preço Unitário
SL-MAR-1,5-0	0,75-1,5mm2 Nº 0	1000 Unid./Rolo	0,016€	SL-MAR-1,5-A	0,75-1,5mm2 Let. A	1000 Unid./Rolo	0,0160€
SL-MAR-1,5-1	0,75-1,5mm2 Nº 1	1000 Unid./Rolo	0,016€	SL-MAR-1,5-B	0,75-1,5mm2 Let. B	1000 Unid./Rolo	0,0160€
SL-MAR-1,5-2	0,75-1,5mm2 Nº 2	1000 Unid./Rolo	0,016€	SL-MAR-1,5-C	0,75-1,5mm2 Let. C	1000 Unid./Rolo	0,0160€
SL-MAR-1,5-3	0,75-1,5mm2 Nº 3	1000 Unid./Rolo	0,016€	SL-MAR-1,5-D	0,75-1,5mm2 Let. D	1000 Unid./Rolo	0,0160€
SL-MAR-1,5-4	0,75-1,5mm2 Nº 4	1000 Unid./Rolo	0,016€	SL-MAR-1,5-E	0,75-1,5mm2 Let. E	1000 Unid./Rolo	0,0160€
SL-MAR-1,5-5	0,75-1,5mm2 Nº 5	1000 Unid./Rolo	0,016€	SL-MAR-1,5-F	0,75-1,5mm2 Let. F	1000 Unid./Rolo	0,0160€
SL-MAR-1,5-6	0,75-1,5mm2 Nº 6	1000 Unid./Rolo	0,016€	SL-MAR-1,5-G	0,75-1,5mm2 Let. G	1000 Unid./Rolo	0,0160€
SL-MAR-1,5-7	0,75-1,5mm2 Nº 7	1000 Unid./Rolo	0,016€	SL-MAR-1,5-H	0,75-1,5mm2 Let. H	1000 Unid./Rolo	0,0160€
SL-MAR-1,5-8	0,75-1,5mm2 Nº 8	1000 Unid./Rolo	0,016€	SL-MAR-1,5-I	0,75-1,5mm2 Let. I	1000 Unid./Rolo	0,0160€
SL-MAR-1,5-9	0,75-1,5mm2 Nº 9	1000 Unid./Rolo	0,016€	SL-MAR-1,5-J	0,75-1,5mm2 Let. J	1000 Unid./Rolo	0,0160€
				SL-MAR-1,5-K	0,75-1,5mm2 Let. K	1000 Unid./Rolo	0,0160€
				SL-MAR-1,5-L	0,75-1,5mm2 Let. L	1000 Unid./Rolo	0,0160€
				SL-MAR-1,5-M	0,75-1,5mm2 Let. M	1000 Unid./Rolo	0,0160€
				SL-MAR-1,5-N	0,75-1,5mm2 Let. N	1000 Unid./Rolo	0,0160€
				SL-MAR-1,5-O	0,75-1,5mm2 Let. O	1000 Unid./Rolo	0,0160€
				SL-MAR-1,5-P	0,75-1,5mm2 Let. P	1000 Unid./Rolo	0,0160€
				SL-MAR-1,5-Q	0,75-1,5mm2 Let. Q	1000 Unid./Rolo	0,0160€
				SL-MAR-1,5-R	0,75-1,5mm2 Let. R	1000 Unid./Rolo	0,0160€
				SL-MAR-1,5-S	0,75-1,5mm2 Let. S	1000 Unid./Rolo	0,0160€
				SL-MAR-1,5-T	0,75-1,5mm2 Let. T	1000 Unid./Rolo	0,0160€
				SL-MAR-1,5-U	0,75-1,5mm2 Let. U	1000 Unid./Rolo	0,0160€
				SL-MAR-1,5-V	0,75-1,5mm2 Let. V	1000 Unid./Rolo	0,0160€
				SL-MAR-1,5-W	0,75-1,5mm2 Let. W	1000 Unid./Rolo	0,0160€
				SL-MAR-1,5-X	0,75-1,5mm2 Let. X	1000 Unid./Rolo	0,0160€
				SL-MAR-1,5-Y	0,75-1,5mm2 Let. Y	1000 Unid./Rolo	0,0160€
				SL-MAR-1,5-Z	0,75-1,5mm2 Let. Z	1000 Unid./Rolo	0,0160€

## Símbolos

Código	Descrição	Qt./ Mín.Venda Rolo 1000 Uni.	Preço Unitário	Código	Descrição	Qt./ Mín.Venda Rolo 1000 Uni.	Preço Unitário
SL-MAR-1,5-*	0,75-1,5mm2, Símbolo *	1000 Unid./Rolo	0,016€	SL-MAR-2,5-A	2,5mm2 Let. A	1000 Unid./Rolo	0,0170€
SL-MAR-1,5+	0,75-1,5mm2, Símbolo +	1000 Unid./Rolo	0,016€	SL-MAR-2,5-B	2,5mm2 Let. B	1000 Unid./Rolo	0,0170€
SL-MAR-1,5-	0,75-1,5mm2, Símbolo -	1000 Unid./Rolo	0,016€	SL-MAR-2,5-C	2,5mm2 Let. C	1000 Unid./Rolo	0,0170€
SL-MAR-1,5/	0,75-1,5mm2, Símbolo /	1000 Unid./Rolo	0,016€	SL-MAR-2,5-D	2,5mm2 Let. D	1000 Unid./Rolo	0,0170€
				SL-MAR-2,5-E	2,5mm2 Let. E	1000 Unid./Rolo	0,0170€
				SL-MAR-2,5-F	2,5mm2 Let. F	1000 Unid./Rolo	0,0170€
				SL-MAR-2,5-G	2,5mm2 Let. G	1000 Unid./Rolo	0,0170€
				SL-MAR-2,5-H	2,5mm2 Let. H	1000 Unid./Rolo	0,0170€
				SL-MAR-2,5-I	2,5mm2 Let. I	1000 Unid./Rolo	0,0170€
				SL-MAR-2,5-J	2,5mm2 Let. J	1000 Unid./Rolo	0,0170€
				SL-MAR-2,5-K	2,5mm2 Let. K	1000 Unid./Rolo	0,0170€
				SL-MAR-2,5-L	2,5mm2 Let. L	1000 Unid./Rolo	0,0170€
				SL-MAR-2,5-M	2,5mm2 Let. M	1000 Unid./Rolo	0,0170€
				SL-MAR-2,5-N	2,5mm2 Let. N	1000 Unid./Rolo	0,0170€
				SL-MAR-2,5-O	2,5mm2 Let. O	1000 Unid./Rolo	0,0170€
				SL-MAR-2,5-P	2,5mm2 Let. P	1000 Unid./Rolo	0,0170€
				SL-MAR-2,5-Q	2,5mm2 Let. Q	1000 Unid./Rolo	0,0170€
				SL-MAR-2,5-R	2,5mm2 Let. R	1000 Unid./Rolo	0,0170€
				SL-MAR-2,5-S	2,5mm2 Let. S	1000 Unid./Rolo	0,0170€
				SL-MAR-2,5-T	2,5mm2 Let. T	1000 Unid./Rolo	0,0170€
				SL-MAR-2,5-U	2,5mm2 Let. U	1000 Unid./Rolo	0,0170€
				SL-MAR-2,5-V	2,5mm2 Let. V	1000 Unid./Rolo	0,0170€
				SL-MAR-2,5-W	2,5mm2 Let. W	1000 Unid./Rolo	0,0170€
				SL-MAR-2,5-X	2,5mm2 Let. X	1000 Unid./Rolo	0,0170€
				SL-MAR-2,5-Y	2,5mm2 Let. Y	1000 Unid./Rolo	0,0170€
				SL-MAR-2,5-Z	2,5mm2 Let. Z	1000 Unid./Rolo	0,0170€

## Símbolos

Código	Descrição	Qt./ Mín.Venda Rolo 1000 Uni.	Preço Unitário	Código	Descrição	Qt./ Mín.Venda Rolo 1000 Uni.	Preço Unitário
SL-MAR-2,5*	2,5mm2 Símbolo *	1000 Unid./Rolo	0,017€				
SL-MAR-2,5+	2,5mm2 Símbolo +	1000 Unid./Rolo	0,017€				
SL-MAR-2,5-	2,5mm2 Símbolo -	1000 Unid./Rolo	0,017€				
SL-MAR-2,5/	2,5mm2 Símbolo /	1000 Unid./Rolo	0,017€				

Material: Nylon PA6.6

Flamabilidade: 94V-2

Temperatura trabalho: -30 / 80° C



Novos  
Podutos

Código	Descrição	Comprimento	Cor	Quantidade Min.Venda	Preço Unitário
SL-PERNO-M6-BR	Perno 6 p/Abraçadeira Fivela	31mm	Branca	100 Unid.	0,0750€
SL-PERNO-M6-PT	Perno 6 p/Abraçadeira Fivela	31mm	Preto	100 Unid.	0,0750€
SL-PERNO-M8-BR	Perno 8 p/Abraçadeira Fivela	36mm	Branca	100 Unid.	0,0850€
SL-PERNO-M8-PT	Perno 8 p/Abraçadeira Fivela	36mm	Preto	100 Unid.	0,0850€
SL-PERNO-M10-BR	Perno 10 p/Abraçadeira Fivela	34,5mm	Branca	100 Unid.	0,0980€
SL-PERNO-M10-PT	Perno 10 p/Abraçadeira Fivela	34,5mm	Preto	100 Unid.	0,0980€

## soflight

Duogel 1000

1 L

## Gel de Silicone Bicomponente

## DESCRIÇÃO

Duogel 1000 é um gel bi componente de silicone utilizado no preenchimento para isolamento elétrica e vedação de baixa tensão até 1 kV.

Os dois componentes fornecidos nas embalagens, misturados na proporção 1:1 garantem, graças a baixa viscosidade, um Rápido e seguro preenchimento do recipiente a preencher.

Duogel 1000 pode ser utilizado parcialmente para mais aplicações de acordo com a necessidade de emprego. Duogel 1000 também pode ser facilmente removido, sem necessidade de ferramentas, mesmo depois de uma instalação longa.

## CARACTERÍSTICAS TÉCNICAS

Rigidez dielétrica	25,5 kV/mm
Proporção de mistura	1:1
Cor	azul
Viscosidade A	2600 mPa
Viscosidade B	110 mPa
Tempo de trabalhabilidade a 23 °C	5 min
Tempo de polimerização a 23 °C	12 min
Temperatura de exercício	-60 °C / +200 °C

Nota: Temperaturas mais altas diminuem o tempo de trabalho e polimerização; Temperaturas mais baixas aumentam o tempo de trabalho e polimerização.



Código:SL-DUOGEL1000

Preço: 63,00€/Litro

## Caminho Cabos Perfurado com Aba 40mm, com União Rápida Acabamento: Sendzimir - EN 10346

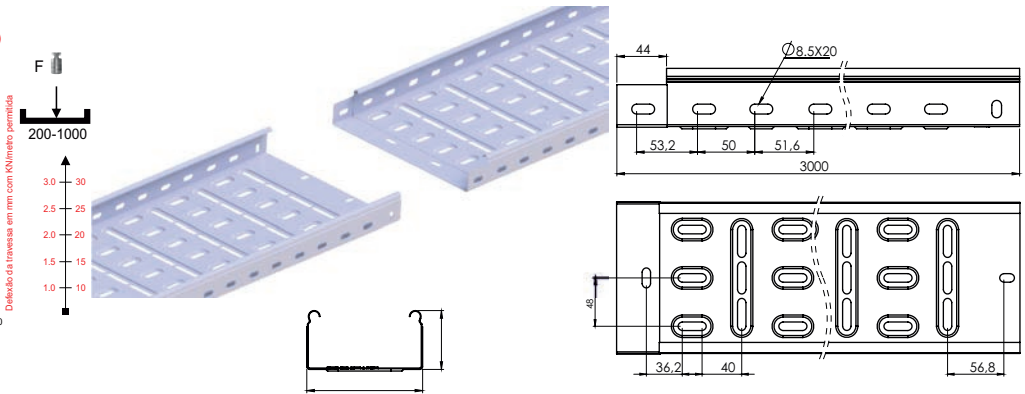
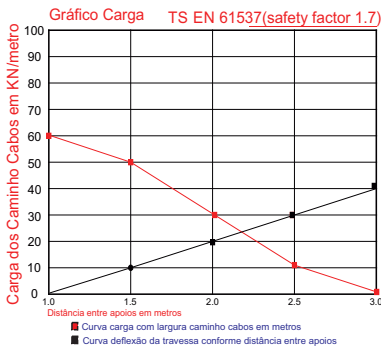

Código	mm	mm	mm	mm	kg/mt	Acabamento	P.U./mt €	
CC-050-40-06-PG	50mm	40mm	3000mm	0,6mm	0,620kg/mt	SENDZIMIR	6,28€	●
CC-100-40-06-PG	100mm	40mm	3000mm	0,6mm	0,857kg/mt	SENDZIMIR	6,35€	●
CC-150-40-06-PG	150mm	40mm	3000mm	0,6mm	1,065kg/mt	SENDZIMIR	6,72€	●
CC-200-40-06-PG	200mm	40mm	3000mm	0,6mm	1.280kg/mt	SENDZIMIR	7,80€	●
CC-300-40-08-PG	300mm	40mm	3000mm	0,8mm	2.280kg/mt	SENDZIMIR	13,73€	●

- Artigo de stock habitual
- Artigo disponível por encomenda

## Caminho Cabos Perfurado com Aba 60mm, com União Rápida Acabamento: Sendzimir e Inox 304 - EN 10346

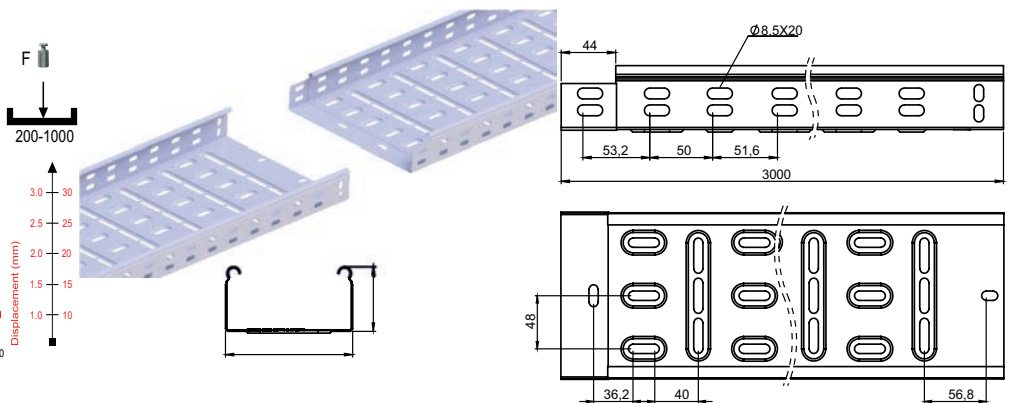
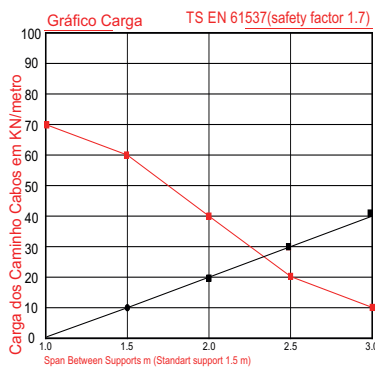

mm	mm	mm	mm	kg/mt	Código ( Inox 304 )	P.U./mt €	Código ( Sendzimir )	P.U./mt €
50mm	50mm	3000mm	0,6mm	0,710kg/mt	CC-050-50-06-SS304	S/Cons.	CC-050-50-06-PG	6,30€
100mm	60mm	3000mm	0,6mm	1,000kg/mt	CC-100-60-06-SS304	36,00€	CC-100-60-06-PG	6,40€
150mm	60mm	3000mm	0,6mm	1,220kg/mt	CC-150-60-06-SS304	44,00€	CC-150-60-06-PG	8,17€
200mm	60mm	3000mm	0,6mm	1,440kg/mt	CC-200-60-06-SS304	48,00€	CC-200-60-06-PG	9,13€
300mm	60mm	3000mm	0,8mm	2,490kg/mt	CC-300-60-08-SS304	77,00€	CC-300-60-08-PG	15,16€
400mm	60mm	3000mm	0,9mm	3,450kg/mt	CC-400-60-09-SS304	S/Cons.	CC-400-60-09-PG	21,30€
500mm	60mm	3000mm	1,0mm	4,210kg/mt	CC-500-60-10-SS304	S/Cons.	CC-500-60-10-PG	28,00€
600mm	60mm	3000mm	1,0mm	4,860kg/mt	CC-600-60-10-SS304	S/Cons.	CC-600-60-10-PG	32,46€

- Artigo de stock habitual
- Artigo disponível por encomenda

### Caminho Cabos Perfurado com Aba 100mm, com União Rápida

Acabamento: Sendzimir - EN 10346  
Acabamento: Galvanizado a Quente - EN 1461

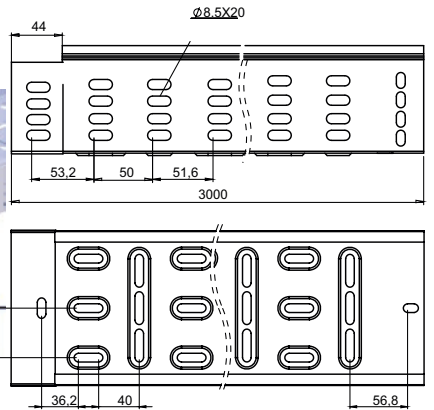
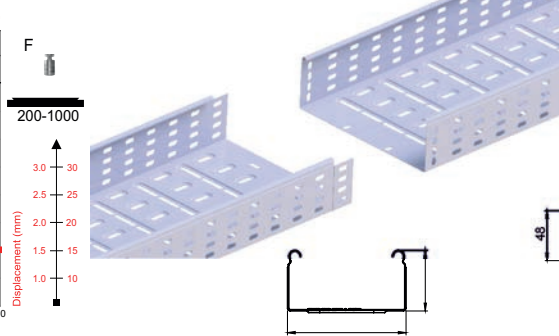
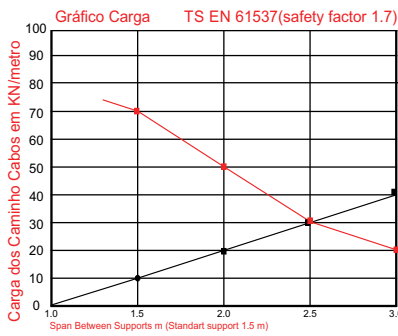

mm	mm	mm	mm	kg/mt	Código(Galvanizado Quente)	P.U./mt €		Código(Sendzimir)	P.U./mt €	
100mm	100mm	3000mm	0,7mm	1,330kg/mt	CC-100-100-07-HDG	36,50€	●	CC-100-100-07-PG	23,00€	●
150mm	100mm	3000mm	0,7mm	1,580kg/mt	CC-150-100-07-HDG	43,25€	●	CC-150-100-07-PG	24,00€	●
200mm	100mm	3000mm	0,8mm	2,090kg/mt	CC-200-100-08-HDG	49,80€	●	CC-200-100-08-PG	27,80€	●
300mm	100mm	3000mm	0,9mm	2,990kg/mt	CC-300-100-09-HDG	74,80€	●	CC-300-100-09-PG	42,00€	●
400mm	100mm	3000mm	0,9mm	3,650kg/mt	CC-400-100-09-HDG	88,90€	●	CC-400-100-09-PG	55,00€	●
500mm	100mm	3000mm	1,2mm	5,100kg/mt	CC-500-100-12-HDG	102,50€	●	CC-500-100-12-PG	62,50€	●
600mm	100mm	3000mm	1,2mm	5,800kg/mt	CC-600-100-12-HDG	113,95€	●	CC-600-100-12-PG	68,15€	●

- Artigo de stock habitual
- Artigo disponível por encomenda

### Caminho Cabos Não Perfurado com Aba 60mm, com União Rápida

Acabamento: Sendzimir - EN 10346  
Acabamento: Galvanizado a Quente - EN 1461

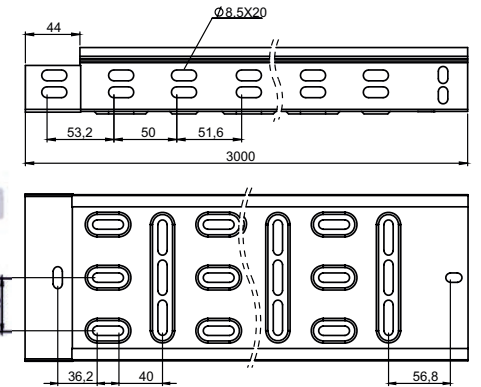
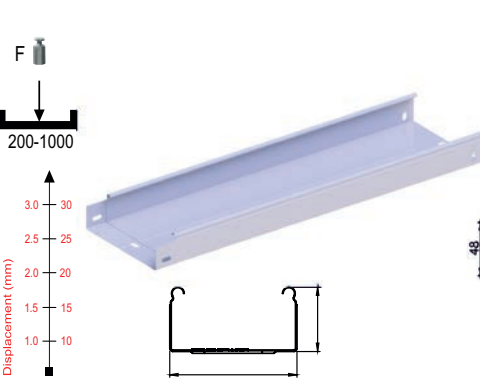
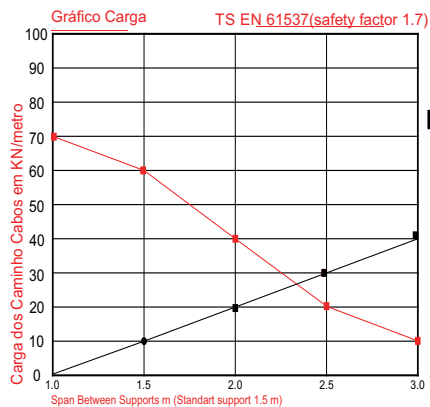

mm	mm	mm	mm	kg/mt	Código(Galvanizado Quente)	P.U./mt €		Código Sendzimir	P.U./mt €	
50mm	50mm	3000mm	0,6mm	0,710kg/mt	CC-050-50-06-NP-HDG	16,90€	●	CC-050-50-06-NP-PG	8,90€	●
100mm	60mm	3000mm	0,6mm	1,000kg/mt	CC-100-60-06-NP-HDG	19,80€	●	CC-100-60-06-NP-PG	10,10€	●
150mm	60mm	3000mm	0,6mm	1,220kg/mt	CC-150-60-06-NP-HDG	23,85€	●	CC-150-60-06-NP-PG	11,95€	●
200mm	60mm	3000mm	0,6mm	1,440kg/mt	CC-200-60-06-NP-HDG	26,50€	●	CC-200-60-06-NP-PG	13,65€	●
300mm	60mm	3000mm	0,8mm	2,490kg/mt	CC-300-60-06-NP-HDG	36,15€	●	CC-300-60-06-NP-PG	17,75€	●
400mm	60mm	3000mm	0,9mm	3,450kg/mt	CC-400-60-09-NP-HDG	45,88€	●	CC-400-60-09-NP-PG	23,35€	●
500mm	60mm	3000mm	1,2mm	4,210kg/mt	CC-500-60-12-NP-HDG	58,75€	●	CC-500-60-12-NP-PG	39,95€	●
600mm	60mm	3000mm	1,2mm	4,860kg/mt	CC-600-60-12-NP-HDG	75,99€	●	CC-600-60-12-NP-PG	46,25€	●

- Artigo de stock habitual
- Artigo disponível por encomenda

## Caminho Cabos Perfurado com Aba 40mm, com União Rápida Acabamento: Galvanizado a Quente - EN 1461

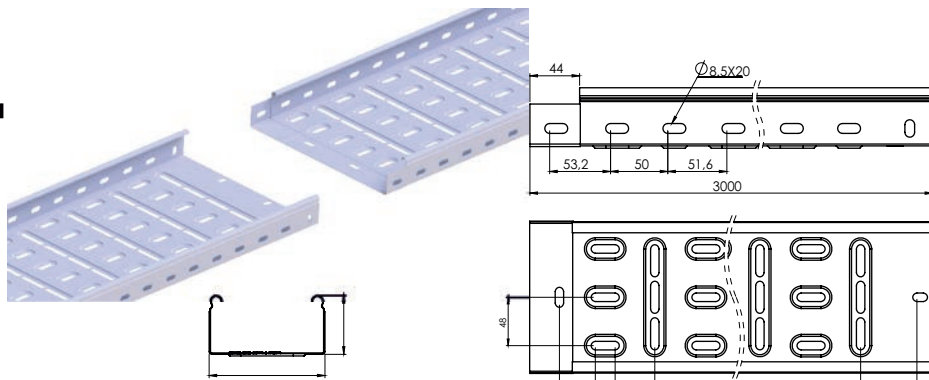
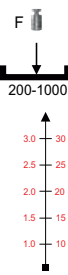
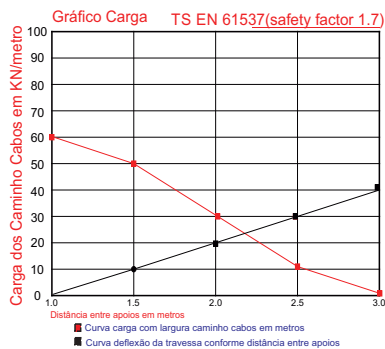

Código	mm	mm	mm	mm	kg/mt	Acabamento	P.U./mt €	
CC-050-40-06-HDG	50mm	40mm	3000mm	0,6mm	0,620kg/mt	Galvanizado a Quente	10,55€	●
CC-100-40-06-HDG	100mm	40mm	3000mm	0,6mm	0,857kg/mt	Galvanizado a Quente	12,15€	●
CC-150-40-06-HDG	150mm	40mm	3000mm	0,6mm	1,065kg/mt	Galvanizado a Quente	16,65€	●
CC-200-40-06-HDG	200mm	40mm	3000mm	0,6mm	1,280kg/mt	Galvanizado a Quente	19,50€	●
CC-300-40-08-HDG	300mm	40mm	3000mm	0,8mm	2,280kg/mt	Galvanizado a Quente	23,55€	●

- Artigo de stock habitual
- Artigo disponível por encomenda

## Caminho Cabos Perdurado com Aba de 60mm Acabamento: Galvanizado a Quente - EN 1461

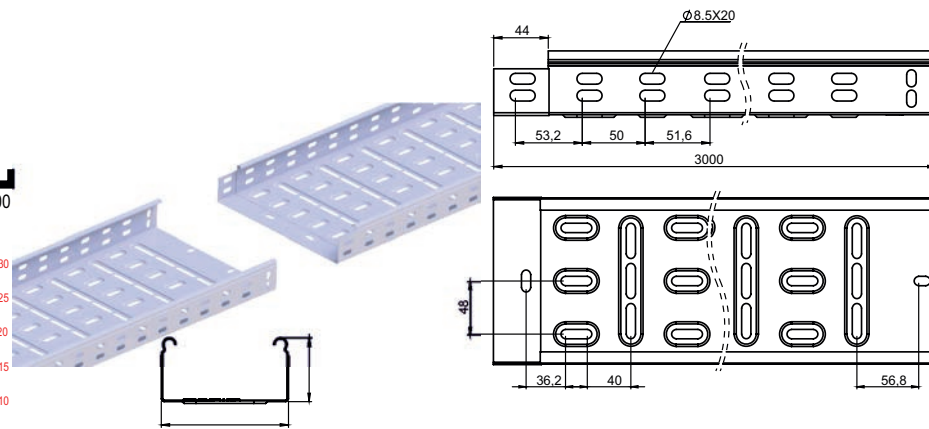
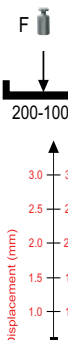
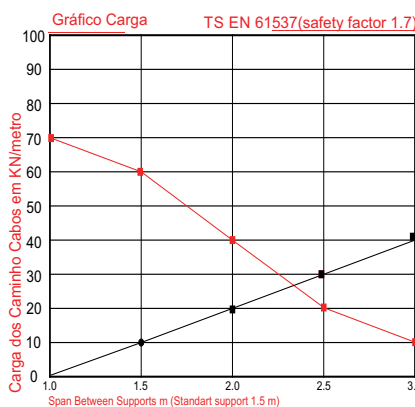

Código	mm	mm	mm	mm	kg/mt	Acabamento	P.U./mt €	
CC-050-50-07-HDG	50mm	50mm	3000mm	0,7mm	0,720kg/mt	Galvanizado a Quente	14,20€	●
CC-100-60-07-HDG	100mm	60mm	3000mm	0,7mm	1,170kg/mt	Galvanizado a Quente	14,65€	●
CC-150-60-07-HDG	150mm	60mm	3000mm	0,7mm	1,420kg/mt	Galvanizado a Quente	17,57€	●
CC-200-60-07-HDG	200mm	60mm	3000mm	0,7mm	1,680kg/mt	Galvanizado a Quente	20,90€	●
CC-300-60-09-HDG	300mm	60mm	3000mm	0,9mm	2,800kg/mt	Galvanizado a Quente	26,90€	●
CC-400-60-10-HDG	400mm	60mm	3000mm	1,0mm	3,840kg/mt	Galvanizado a Quente	38,82€	●
CC-500-60-12-HDG	500mm	60mm	3000mm	1,2mm	4,270kg/mt	Galvanizado a Quente	47,50€	●
CC-600-60-12-HDG	600mm	60mm	3000mm	1,2mm	4,960kg/mt	Galvanizado a Quente	60,40€	●

- Artigo de stock habitual
- Artigo disponível por encomenda

## União Lateral para Caminho Cabos

Acabamento: Sendzimir - EN 10346

Acabamento: Galvanizado a Quente - EN 1461

União 40/50mm

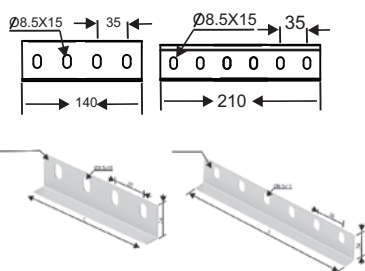

União 60mm

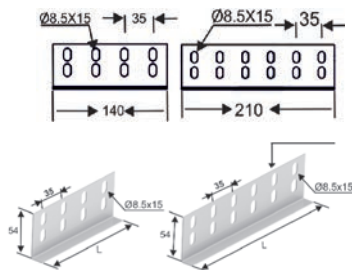

União 100mm

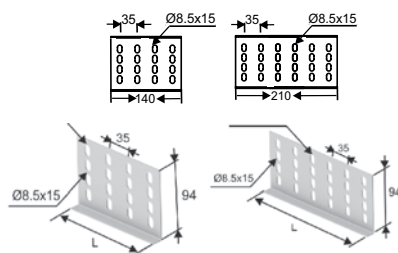

mm	mm	kg	mm	Código (Galvanizado Quente)	P.U. €		Código (Sendzimir)	P.U. €	
40mm	145mm	0,055kg	1,2mm	CC-U1-040L145-HDG	3,65€	●	CC-U1-040L145-PG	0,69€	●
50mm	145mm	0,070kg	1,2mm	CC-U1-050L145-HDG	4,25€	●	CC-U1-050L145-PG	1,45€	●
60mm	145mm	0,078kg	1,2mm	CC-U1-060L145-HDG	4,95€	●	CC-U1-060L145-PG	1,59€	●
60mm	210mm	0,120kg	1,2mm	CC-U1-060L210-HDG	5,25€	●	CC-U1-060L210-PG	1,80€	●
100mm	210mm	0,175kg	1,2mm	CC-U1-100L210-HDG	5,95€	●	CC-U1-100L210-PG	2,35€	●

- Artigo de stock habitual
- Artigo disponível por encomenda

## Tampa para Caminho Cabos em Chapa e Varão

Acabamento: Sendzimir - EN 10346

Acabamento: Galvanizado a Quente - EN 1461

Tampa de Encaixe por pressão,  
Não necessita de Clip fixação

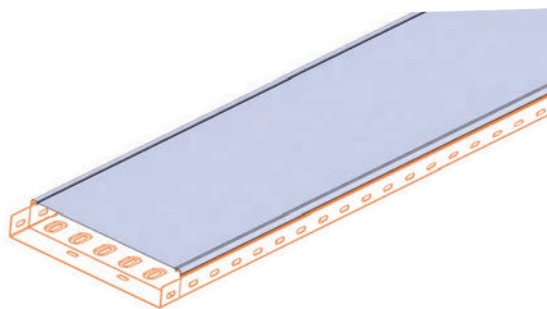
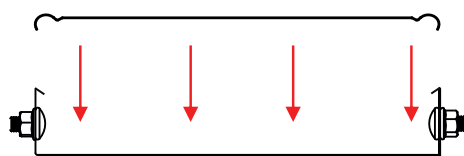

mm	mm	mm	kg/mt	Código (Galvanizado Quente)	P.U./mt €		Código (Sendzimir)	P.U./mt €	
50mm	0,6mm	3000mm	0,270kg/mt	CV-TP-050-07-HDG(p/Cam.Cabos de Varão)	4,42€	●	CV-TP-050-06-PG(p/Cam.Cabos Varão)	2,55€	●
50mm	0,6mm	3000mm	0,270kg/mt	CC-TP-050-07-HDG	4,42€	●	CC-TP-050-06-PG	2,55€	●
100mm	0,6mm	3000mm	0,470kg/mt	CC-TP-100-07-HDG	6,32€	●	CC-TP-100-06-PG	3,99€	●
150mm	0,6mm	3000mm	0,660kg/mt	CC-TP-150-07-HDG	8,50€	●	CC-TP-150-06-PG	5,45€	●
200mm	0,7mm	3000mm	1,030kg/mt	CC-TP-200-08-HDG	10,75€	●	CC-TP-200-07-PG	6,91€	●
300mm	0,8mm	3000mm	1,750kg/mt	CC-TP-300-08-HDG	19,50€	●	CC-TP-300-08-PG	12,68€	●
400mm	0,8mm	3000mm	2,300kg/mt	CC-TP-400-08-HDG	25,30€	●	CC-TP-400-08-PG	16,49€	●
500mm	1,0mm	3000mm	3,670kg/mt	CC-TP-500-10-HDG	38,50€	●	CC-TP-500-10-PG	25,11€	●
600mm	1,0mm	3000mm	4,380kg/mt	CC-TP-600-10-HDG	45,60€	●	CC-TP-600-10-PG	29,95€	●

- Artigo de stock habitual
- Artigo disponível por encomenda

## Curva Ajustável 90° a 180° para Caminho Cabos

Acabamento: Sendzimir - EN 10346

Acabamento: Galvanizado a Quente - EN 1461

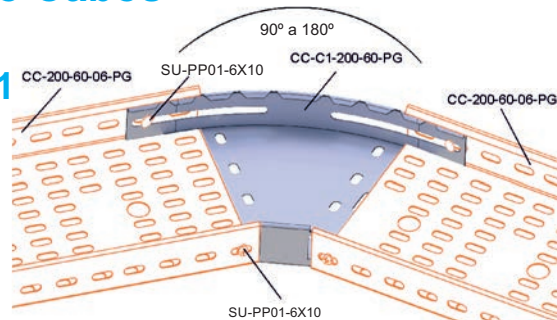
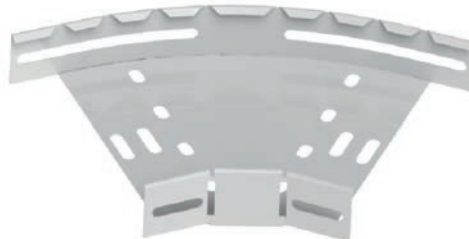
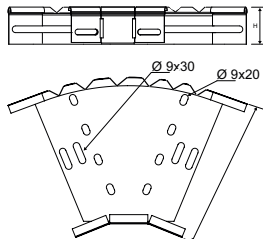

mm	mm	kg	mm	Código (Galvanizado Quente)	P.U. €	Código (Sendzimir)	P.U. €
50mm	40mm	0,180kg	1,2mm	CC-C1-050-40-HDG	28,00€	CC-C1-050-40-PG	20,70€
100mm	40mm	0,230kg	1,2mm	CC-C1-100-40-HDG	32,75€	CC-C1-100-40-PG	24,25€
150mm	40mm	0,300kg	1,2mm	CC-C1-150-40-HDG	34,65€	CC-C1-150-40-PG	25,65€
200mm	40mm	0,320kg	1,2mm	CC-C1-200-40-HDG	36,25€	CC-C1-200-40-PG	26,85€
300mm	40mm	0,390kg	1,2mm	CC-C1-300-40-HDG	56,85€	CC-C1-300-40-PG	42,15€
50mm	50mm	0,200Kg	1,2mm	CC-C1-050-50-HDG	29,65€	CC-C1-050-50-PG	21,90€
100mm	60mm	0,280kg	1,2mm	CC-C1-100-60-HDG	32,80€	CC-C1-100-60-PG	24,25€
150mm	60mm	0,280kg	1,2mm	CC-C1-150-60-HDG	34,85€	CC-C1-150-60-PG	25,65€
200mm	60mm	0,330kg	1,2mm	CC-C1-200-60-HDG	36,35€	CC-C1-200-60-PG	26,85€
300mm	60mm	0,470kg	1,2mm	CC-C1-300-60-HDG	56,00€	CC-C1-300-60-PG	41,50€
400mm	60mm	0,540kg	1,2mm	CC-C1-400-60-HDG	112,55€	CC-C1-400-60-PG	83,35€
500mm	60mm	0,590kg	1,2mm	CC-C1-500-60-HDG	138,85€	CC-C1-500-60-PG	102,85€
600mm	60mm	0620kg	1,2mm	CC-C1-600-60-HDG	163,30€	CC-C1-600-60-PG	120,90€

- Artigo de stock habitual
- Artigo disponível por encomenda

## União Vertical Ajustável para Caminho Cabos

Acabamento: Sendzimir - EN 10346

Acabamento: Galvanizado a Quente - EN 1461

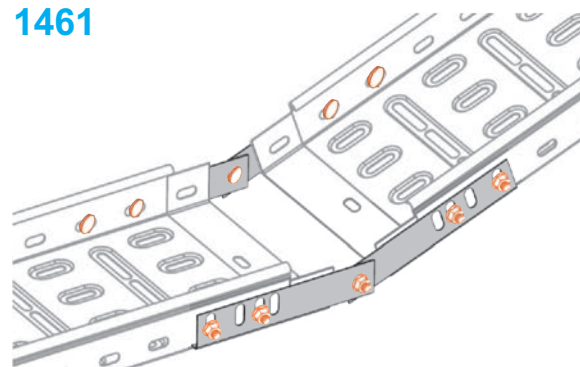
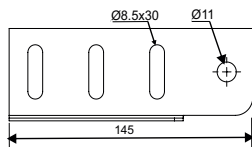

mm	mm	kg	mm	Código (Galvanizado Quente)	P.U. €	Código (Sendzimir)	P.U. €
40mm	160mm	0,055kg	1,2mm	CC-U2-040L160-HDG	8,85€	CC-U2-040L160-PG	4,35€
50mm	160mm	0,085kg	1,2mm	CC-U2-050L160-HDG	9,30€	CC-U2-050L160-PG	4,65€
60mm	160mm	0,100kg	1,2mm	CC-U2-060L160-HDG	9,60€	CC-U2-060L160-PG	4,85€
100mm	160mm	0,160kg	1,2mm	CC-U2-100L-160-HDG	18,85€	CC-U2-100L-160-PG	9,70€

- Artigo de stock habitual
- Artigo disponível por encomenda

## União Horizontal Interior/Exterior para Caminho Cabos

Acabamento: Sendzimir - EN 10346

Acabamento: Galvanizado a Quente - EN 1461

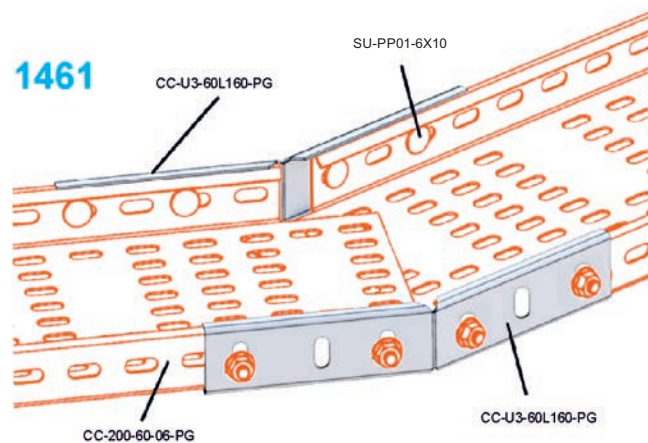
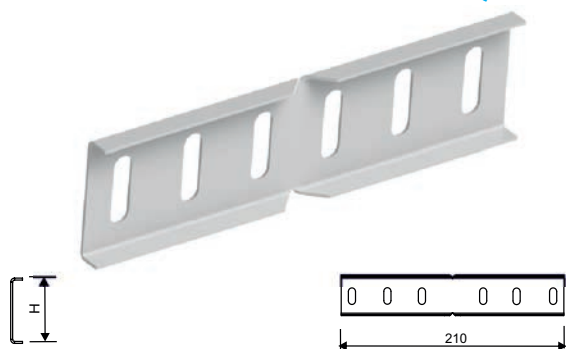

mm	mm	mm	kg	Código ( Galvanizado Quente )	P.U. €	Código ( Sendzimir )	P.U. €
40mm	210mm	1,2mm	0,190kg	CC-U3-040L210-HDG	7,70€	CC-U3-040L210-PG	4,45€
50mm	210mm	1,2mm	0,160kg	CC-U3-050L210-HDG	9,40€	CC-U3-050L210-PG	4,70€
60mm	210mm	1,2mm	0,255kg	CC-U3-060L210-HDG	10,00€	CC-U3-060L210-PG	5,20€
100mm	210mm	1,2mm	0,260kg	CC-U3-100L-210-HDG	13,40€	CC-U3-100L-210-PG	7,70€

- Artigo de stock habitual
- Artigo disponível por encomenda

## Tê Vertical para Caminho Cabos

Acabamento: Sendzimir - EN 10346

Acabamento: Galvanizado a Quente - EN 1461

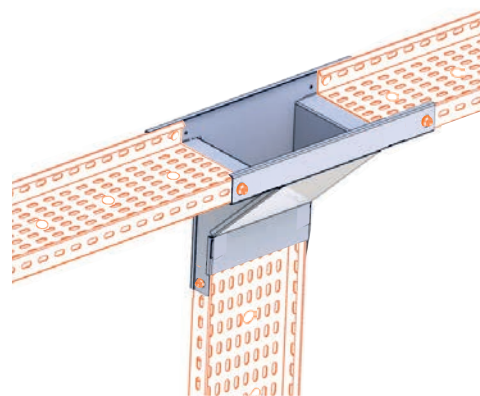
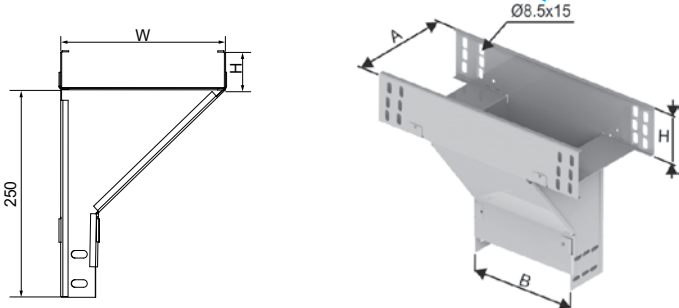

mm	mm	mm	kg	Código ( Galvanizado Quente )	P.U. €	Código ( Sendzimir )	P.U. €
50mm	40mm	1,2mm	1,150kg	CC-T1-050-40-HDG	52,20€	CC-T1-050-40-PG	38,65€
100mm	40mm	1,2mm	1,675kg	CC-T1-100-40-HDG	79,10€	CC-T1-100-40-PG	58,55€
150mm	40mm	1,2mm	2,195kg	CC-T1-150-40-HDG	110,60€	CC-T1-150-40-PG	81,90€
200mm	40mm	1,2mm	2,870kg	CC-T1-200-40-HDG	129,50€	CC-T1-200-40-PG	95,95€
300mm	40mm	1,2mm	4,285kg	CC-T1-300-40-HDG	192,60€	CC-T1-300-40-PG	142,69€
50mm	50mm	1,2mm	1,290kg	CC-T1-050-50-HDG	57,65€	CC-T1-050-50-PG	42,70€
100mm	60mm	1,2mm	1,985kg	CC-T1-100-60-HDG	88,50€	CC-T1-100-60-PG	65,55€
150mm	60mm	1,2mm	2,190kg	CC-T1-150-60-HDG	107,40€	CC-T1-150-60-PG	79,60€
200mm	60mm	1,2mm	3,220kg	CC-T1-200-60-HDG	145,40€	CC-T1-200-60-PG	107,65€
300mm	60mm	1,2mm	4,685kg	CC-T1-300-60-HDG	224,35€	CC-T1-300-60-PG	166,15€
400mm	60mm	1,2mm	8,500kg	CC-T1-400-60-HDG	353,80€	CC-T1-400-60-PG	262,00€
500mm	60mm	1,2mm	11,140kg	CC-T1-500-60-HDG	467,50€	CC-T1-500-60-PG	346,25€
600mm	60mm	1,2mm	13,980kg	CC-T1-600-60-HDG	590,35€	CC-T1-600-60-PG	437,25€

- Artigo de stock habitual
- Artigo disponível por encomenda



# Curva Interior 90° para Caminho Cabos

Acabamento: Sendzimir - EN 10346  
Acabamento: Galvanizado a Quente - EN 1461

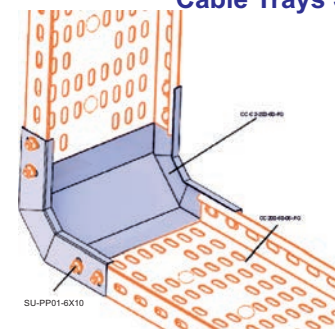
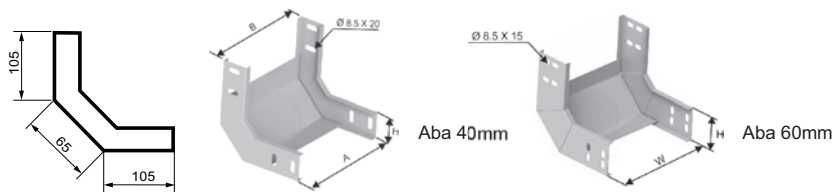

mm	mm	mm	kg	Código (Galvanizado Quente)	P.U. €		Código (Sendzimir)	P.U. €	
50mm	40mm	1,2mm	0,340kg	CC-C2-050-40-HDG	21,15€	●	CC-C2-050-40-PG	15,65€	●
100mm	40mm	1,2mm	0,410kg	CC-C2-100-40-HDG	24,10€	●	CC-C2-100-40-PG	17,85€	●
150mm	40mm	1,2mm	0,475kg	CC-C2-150-40-HDG	29,50€	●	CC-C2-150-40-PG	21,85€	●
200mm	40mm	1,2mm	0,550kg	CC-C2-200-40-HDG	35,35€	●	CC-C2-200-40-PG	26,15€	●
300mm	40mm	1,2mm	0,685kg	CC-C2-300-40-HDG	26,90€	●	CC-C2-300-40-PG	36,25€	●
50mm	50mm	1,2mm	0,405kg	CC-C2-050-50-HDG	23,90€	●	CC-C2-050-50-PG	17,70€	●
100mm	60mm	1,2mm	0,555kg	CC-C2-100-60-HDG	24,80€	●	CC-C2-100-60-PG	18,35€	●
150mm	60mm	1,2mm	0,640kg	CC-C2-150-60-HDG	29,50€	●	CC-C2-150-60-PG	21,85€	●
200mm	60mm	1,2mm	0,725kg	CC-C2-200-60-HDG	32,55€	●	CC-C2-200-60-PG	24,10€	●
300mm	60mm	1,2mm	0,895kg	CC-C2-300-60-HDG	49,10€	●	CC-C2-300-60-PG	36,35€	●
400mm	60mm	1,2mm	1,070kg	CC-C2-400-60-HDG	64,95€	●	CC-C2-400-60-PG	48,10€	●
500mm	60mm	1,2mm	1,240kg	CC-C2-500-60-HDG	71,45€	●	CC-C2-500-60-PG	52,90€	●
600mm	60mm	1,2mm	1,410kg	CC-C2-600-60-HDG	93,70€	●	CC-C2-600-60-PG	69,40€	●
100mm	100mm	1,2mm	0,920kg	CC-C2-100-100-HDG	35,50€	●	CC-C2-100-100-PG	24,85€	●
200mm	100mm	1,2mm	1,050kg	CC-C2-200-100-HDG	43,55€	●	CC-C2-200-100-PG	30,10€	●
300mm	100mm	1,2mm	1,175kg	CC-C2-300-100-HDG	55,10€	●	CC-C2-300-100-PG	38,35€	●
400mm	100mm	1,2mm	1,250kg	CC-C2-400-100-HDG	74,95€	●	CC-C2-400-100-PG	52,10€	●
500mm	100mm	1,2mm	1,375kg	CC-C2-500-100-HDG	83,45€	●	CC-C2-500-100-PG	57,90€	●
600mm	100mm	1,2mm	1,530kg	CC-C2-600-100-HDG	107,70€	●	CC-C2-600-100-PG	74,40€	●

- Artigo de stock habitual
- Artigo disponível por encomenda

# Tampa para Curva Interior 90° para Caminho Cabos

Acabamento: Sendzimir - EN 10346  
Acabamento: Galvanizado a Quente - EN 1461

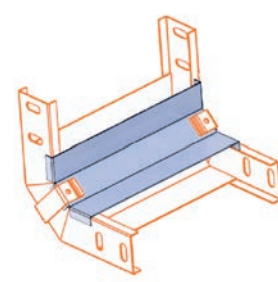
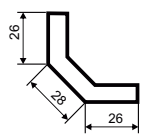

mm	mm	kg	Código (Galvanizado Quente)	P.U. €		Código (Sendzimir)	P.U. €	
50mm	1,2mm	0,340kg	CC-TP-C2-050-40-HDG	9,40€	●	CC-TP-C2-050-40-PG	6,95€	●
100mm	1,2mm	0,410kg	CC-TP-C2-100-40-HDG	11,00€	●	CC-TP-C2-100-40-PG	8,10€	●
150mm	1,2mm	0,475kg	CC-TP-C2-150-40-HDG	14,45€	●	CC-TP-C2-150-40-PG	10,70€	●
200mm	1,2mm	0,550kg	CC-TP-C2-200-40-HDG	25,45€	●	CC-TP-C2-200-40-PG	11,85€	●
300mm	1,2mm	0,685kg	CC-TP-C2-300-40-HDG	24,80€	●	CC-TP-C2-300-40-PG	18,35€	●
400mm	1,2mm	1,070kg	CC-TP-C2-400-60-HDG	32,55€	●	CC-TP-C2-400-60-PG	24,10€	●
500mm	1,2mm	1,240kg	CC-TP-C2-500-60-HDG	36,10€	●	CC-TP-C2-500-60-PG	26,70€	●
600mm	1,2mm	1,410kg	CC-TP-C2-600-60-HDG	37,80€	●	CC-TP-C2-600-60-PG	28,00€	●

- Artigo de stock habitual
- Artigo disponível por encomenda

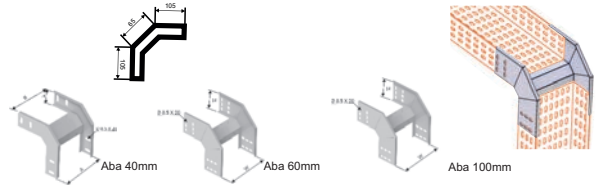

## Curva Exterior 90° para Caminho Cabos

### Acabamento: Sendzimir - EN 10346

### Acabamento: Galvanizado a Quente - EN 1461

mm	mm	mm	kg	Código (Galvanizado Quente)	P.U. €		Código (Sendzimir)	P.U. €	
50mm	40mm	1,2mm	0,310kg	CC-C3-050-40-HDG	21,15€	●	CC-C3-050-40-PG	15,65€	●
100mm	40mm	1,2mm	0,345kg	CC-C3-100-40-HDG	24,80€	●	CC-C3-100-40-PG	18,35€	●
150mm	40mm	1,2mm	0,380kg	CC-C3-150-40-HDG	29,50€	●	CC-C3-150-40-PG	21,85€	●
200mm	40mm	1,2mm	0,420kg	CC-C3-200-40-HDG	35,30€	●	CC-C3-200-40-PG	26,15€	●
300mm	40mm	1,2mm	0,500kg	CC-C3-300-40-HDG	48,95€	●	CC-C3-300-40-PG	36,25€	●
50mm	50mm	1,2mm	0,310kg	CC-C3-050-50-HDG	22,55€	●	CC-C3-050-50-PG	16,70€	●
100mm	60mm	1,2mm	0,460kg	CC-C3-100-60-HDG	24,80€	●	CC-C3-100-60-PG	18,35€	●
150mm	60mm	1,2mm	0,490kg	CC-C3-150-60-HDG	29,50€	●	CC-C3-150-60-PG	21,85€	●
200mm	60mm	1,2mm	0,535kg	CC-C3-200-60-HDG	32,55€	●	CC-C3-200-60-PG	24,10€	●
300mm	60mm	1,2mm	0,610kg	CC-C3-300-60-HDG	49,10€	●	CC-C3-300-60-PG	36,35€	●
400mm	60mm	1,2mm	0,685kg	CC-C3-400-60-HDG	65,00€	●	CC-C3-400-60-PG	48,10€	●
500mm	60mm	1,2mm	0,760kg	CC-C3-500-60-HDG	71,45€	●	CC-C3-500-60-PG	52,90€	●
600mm	60mm	1,2mm	0,835kg	CC-C3-600-60-HDG	93,70€	●	CC-C3-600-60-PG	69,40€	●
100mm	100mm	1,2mm	0,590kg	CC-C3-100-100-HDG	34,50€	●	CC-C3-100-100-PG	23,85€	●
200mm	100mm	1,2mm	0,635kg	CC-C3-200-100-HDG	37,55€	●	CC-C3-200-100-PG	26,10€	●
300mm	100mm	1,2mm	0,710kg	CC-C3-300-100-HDG	56,10€	●	CC-C3-300-100-PG	39,35€	●
400mm	100mm	1,2mm	0,885kg	CC-C3-400-100-HDG	76,00€	●	CC-C3-400-100-PG	53,10€	●
500mm	100mm	1,2mm	0,960kg	CC-C3-500-100-HDG	81,45€	●	CC-C3-500-100-PG	56,90€	●
600mm	100mm	1,2mm	1,035kg	CC-C3-600-100-HDG	110,70€	●	CC-C3-600-100-PG	76,40€	●

- Artigo de stock habitual
- Artigo disponível por encomenda

## Tampa p/Curva Exterior 90° para Caminho Cabos

### Acabamento: Sendzimir - EN 10346

### Acabamento: Galvanizado a Quente - EN 1461

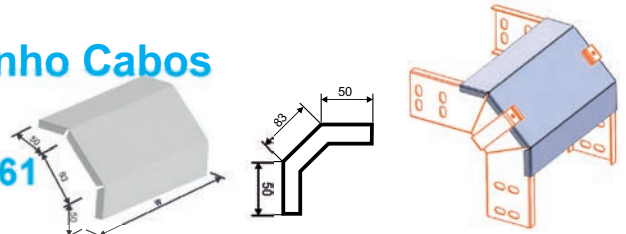

mm	mm	mm	kg	Código (Galvanizado Quente)	P.U. €		Código (Sendzimir)	P.U. €	
50mm	40mm	1,2mm	0,100kg	CC-TP-C3-050-40-HDG	9,40€	●	CC-TP-C3-050-40-PG	6,95€	●
100mm	40mm	1,2mm	0,170kg	CC-TP-C3-100-40-HDG	10,95€	●	CC-TP-C3-100-40-PG	8,10€	●
150mm	40mm	1,2mm	0,260kg	CC-TP-C3-150-40-HDG	14,45€	●	CC-TP-C3-150-40-PG	10,70€	●
200mm	40mm	1,2mm	0,310kg	CC-TP-C3-200-40-HDG	16,00€	●	CC-TP-C3-200-40-PG	11,85€	●
300mm	40mm	1,2mm	0,450kg	CC-TP-C3-300-40-HDG	24,80€	●	CC-TP-C3-300-40-PG	18,35€	●
50mm	50mm	1,2mm	0,110kg	CC-TP-C3-050-50-HDG	9,45€	●	CC-TP-C3-050-50-PG	7,00€	●
100mm	60mm	1,2mm	0,210kg	CC-TP-C3-100-60-HDG	10,95€	●	CC-TP-C3-100-60-PG	8,10€	●
150mm	60mm	1,2mm	0,310kg	CC-TP-C3-150-60-HDG	14,45€	●	CC-TP-C3-150-60-PG	10,70€	●
200mm	60mm	1,2mm	0,380kg	CC-TP-C3-200-60-HDG	16,00€	●	CC-TP-C3-200-60-PG	11,85€	●
300mm	60mm	1,2mm	0,550kg	CC-TP-C3-300-60-HDG	24,80€	●	CC-TP-C3-300-60-PG	18,35€	●
400mm	60mm	1,2mm	0,730kg	CC-TP-C3-400-60-HDG	32,55€	●	CC-TP-C3-400-60-PG	24,10€	●
500mm	60mm	1,2mm	0,900kg	CC-TP-C3-500-60-HDG	36,10€	●	CC-TP-C3-500-60-PG	26,70€	●
600mm	60mm	1,2mm	1,070kg	CC-TP-C3-600-60-HDG	32,75€	●	CC-TP-C3-600-60-PG	27,95€	●

- Artigo de stock habitual
- Artigo disponível por encomenda

# Curva Interior / Exterior Ajustável P/Caminho Cabos

Acabamento: Sendzimir - EN 10346

Acabamento: Galvanizado a Quente - EN 1461

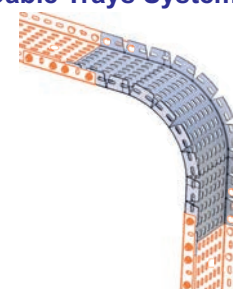
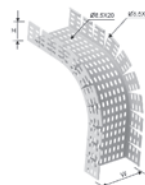
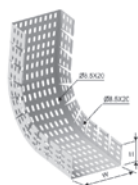

mm	mm	mm	kg	Código (Galvanizado Quente)	P.U. €		Código (Sendzimir)	P.U. €	
50mm	40mm	1,2mm	0,310kg	CC-C4-050-40-HDG	37,10€	●	CC-C4-050-40-PG	27,45€	●
100mm	40mm	1,2mm	0,345kg	CC-C4-100-40-HDG	49,55€	●	CC-C4-100-40-PG	36,70€	●
150mm	40mm	1,2mm	0,380kg	CC-C4-150-40-HDG	64,35€	●	CC-C4-150-40-PG	47,65€	●
200mm	40mm	1,2mm	0,420kg	CC-C4-200-40-HDG	74,40€	●	CC-C4-200-40-PG	55,10€	●
300mm	40mm	1,2mm	0,500kg	CC-C4-300-40-HDG	99,00€	●	CC-C4-300-40-PG	73,30€	●
50mm	50mm	1,2mm	0,310kg	CC-C4-050-50-HDG	52,65€	●	CC-C4-050-50-PG	39,00€	●
100mm	60mm	1,2mm	0,460kg	CC-C4-100-60-HDG	59,40€	●	CC-C4-100-60-PG	44,00€	●
150mm	60mm	1,2mm	0,490kg	CC-C4-150-60-HDG	74,40€	●	CC-C4-150-60-PG	55,10€	●
200mm	60mm	1,2mm	0,535kg	CC-C4-200-60-HDG	84,20€	●	CC-C4-200-60-PG	62,35€	●
300mm	60mm	1,2mm	0,610kg	CC-C4-300-60-HDG	108,90€	●	CC-C4-300-60-PG	80,60€	●
400mm	60mm	1,2mm	0,685kg	CC-C4-400-60-HDG	166,30€	●	CC-C4-400-60-PG	123,15€	●
500mm	60mm	1,2mm	0,760kg	CC-C4-500-60-HDG	197,95€	●	CC-C4-500-60-PG	146,60€	●
600mm	60mm	1,2mm	0,835kg	CC-C4-600-60-HDG	225,65€	●	CC-C4-600-60-PG	167,15€	●
100mm	100mm	1,2mm	0,520kg	CC-C4-100-100-HDG	67,40€	●	CC-C4-100-100-PG	47,10€	●
200mm	100mm	1,2mm	0,595kg	CC-C4-200-100-HDG	94,20€	●	CC-C4-200-100-PG	66,35€	●
300mm	100mm	1,2mm	0,680kg	CC-C4-300-100-HDG	120,90€	●	CC-C4-300-100-PG	84,60€	●
400mm	100mm	1,2mm	0,705kg	CC-C4-400-100-HDG	184,30€	●	CC-C4-400-100-PG	129,15€	●
500mm	100mm	1,2mm	0,780kg	CC-C4-500-100-HDG	219,95€	●	CC-C4-500-100-PG	153,60€	●
600mm	100mm	1,2mm	0,895kg	CC-C4-600-100-HDG	250,65€	●	CC-C4-600-100-PG	175,15€	●

# Tampa P/ Curva Int./ Exterior P/ Caminho Cabos

Acabamento: Sendzimir - EN 10346

Acabamento: Galvanizado a Quente - EN 1461

- Artigo de stock habitual
- Artigo disponível por encomenda

CC-TP-C4-200-PG

CC-TP-C4-200-PG

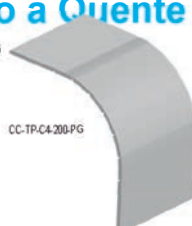

CC-TP-C4-200-PG

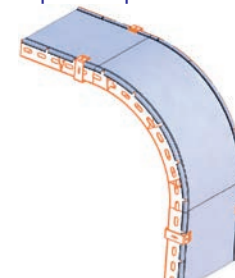
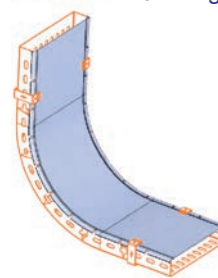

mm	mm	kg	Código (Galvanizado Quente)	P.U. €		Código (Sendzimir)	P.U. €	
50mm	1,0mm	0,570kg	CC-TP-C4-050-HDG	18,65€	●	CC-TP-C4-050-PG	13,80€	●
100mm	1,0mm	0,970kg	CC-TP-C4-100-HDG	31,00€	●	CC-TP-C4-100-PG	22,95€	●
150mm	1,0mm	1,460kg	CC-TP-C4-150-HDG	45,80€	●	CC-TP-C4-150-PG	33,90€	●
200mm	1,0mm	1,780kg	CC-TP-C4-200-HDG	55,65€	●	CC-TP-C4-200-PG	41,20€	●
300mm	1,0mm	2,590kg	CC-TP-C4-300-HDG	80,40€	●	CC-TP-C4-300-PG	59,55€	●
400mm	1,0mm	4,520kg	CC-TP-C4-400-HDG	131,45€	●	CC-TP-C4-400-PG	97,35€	●
500mm	1,0mm	5,600kg	CC-TP-C4-500-HDG	162,40€	●	CC-TP-C4-500-PG	120,25€	●
600mm	1,0mm	6,670kg	CC-TP-C4-600-HDG	193,20€	●	CC-TP-C4-600-PG	143,10€	●

- Artigo de stock habitual
- Artigo disponível por encomenda

## Curva Angular Lateral para Caminho Cabos

Acabamento: Sendzimir - EN 10346

Acabamento: Galvanizado a Quente - EN 1461

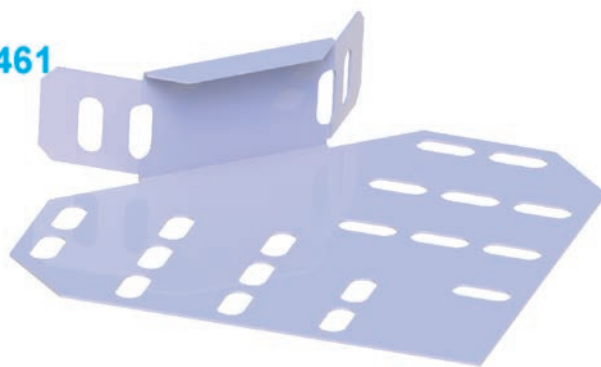

mm	mm	kg	Código (Galvanizado Quente)	P.U. €		Código (Sendzimir)	P.U. €	
40mm	1,2mm	0,200kg	CC-C6-040-HDG	13,10€	●	CC-C6-040-PG	9,70€	●
50mm	1,2mm	0,250kg	CC-C6-050-HDG	13,65€	●	CC-C6-050-PG	10,10€	●
60mm	1,2mm	0,300kg	CC-C6-060-HDG	14,25€	●	CC-C6-060-PG	10,55€	●

- Artigo de stock habitual
- Artigo disponível por encomenda

## Derivação Angular Lateral para Caminho Cabos

Acabamento: Sendzimir - EN 10346

Acabamento: Galvanizado a Quente - EN 1461

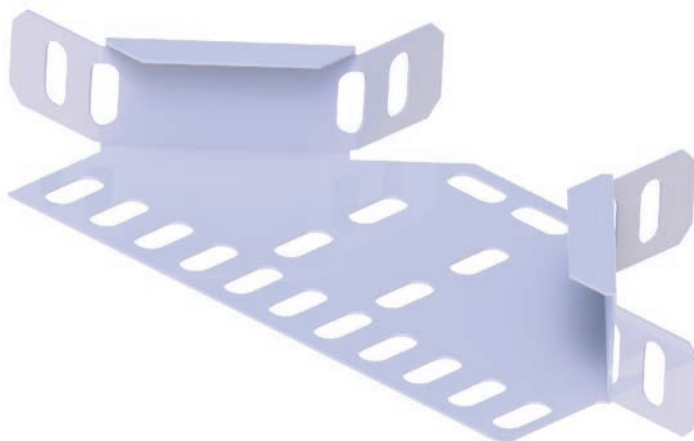

mm	mm	mm	kg	Código (Galvanizado Quente)	P.U. €		Código (Sendzimir)	P.U. €	
50mm	40mm	1,2mm	0,145kg	CC-T3-050-40-HDG	27,25€	●	CC-T3-050-40-PG	20,15€	●
100mm	40mm	1,2mm	0,205kg	CC-T3-100-40-HDG	29,70€	●	CC-T3-100-40-PG	22,00€	●
150mm	40mm	1,2mm	0,230kg	CC-T3-150-40-HDG	31,60€	●	CC-T3-150-40-PG	23,40€	●
200mm	40mm	1,2mm	0,255kg	CC-T3-200-40-HDG	34,80€	●	CC-T3-200-40-PG	25,75€	●
300mm	40mm	1,2mm	0,320kg	CC-T3-300-40-HDG	51,45€	●	CC-T3-300-40-PG	38,10€	●
50mm	50mm	1,2mm	0,170kg	CC-T3-050-50-HDG	30,25€	●	CC-T3-050-50-PG	22,40€	●
100mm	60mm	1,2mm	0,190kg	CC-T3-100-60-HDG	31,60€	●	CC-T3-100-60-PG	23,40€	●
150mm	60mm	1,2mm	0,260kg	CC-T3-150-60-HDG	32,95€	●	CC-T3-150-60-PG	24,40€	●
200mm	60mm	1,2mm	0,260kg	CC-T3-200-60-HDG	34,80€	●	CC-T3-200-60-PG	25,75€	●
300mm	60mm	1,2mm	0,330kg	CC-T3-300-60-HDG	51,50€	●	CC-T3-300-60-PG	38,15€	●
400mm	60mm	1,2mm	0,450kg	CC-T3-400-60-HDG	74,20€	●	CC-T3-400-60-PG	54,95€	●
500mm	60mm	1,2mm	0,550kg	CC-T3-500-60-HDG	84,00€	●	CC-T3-500-60-PG	62,20€	●
600mm	60mm	1,2mm	0,600kg	CC-T3-600-60-HDG	89,85€	●	CC-T3-600-60-PG	66,55€	●

- Artigo de stock habitual
- Artigo disponível por encomenda

**Curva Plana para Caminho Cabos**  
**Acabamento: Sendzimir - EN 10346**  
**Acabamento: Galvanizado a Quente - EN 1461**

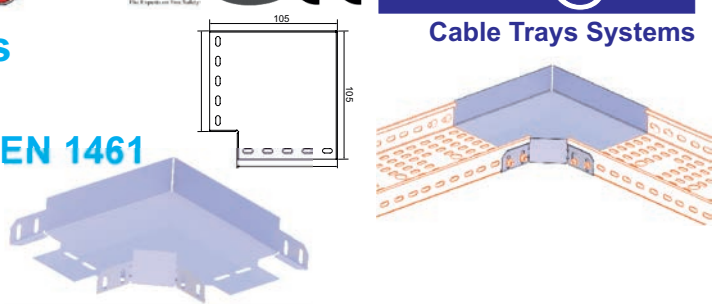

mm	mm	mm	kg	Código (Galvanizado Quente)	P.U. €	Código (Sendzimir)	P.U. €
50mm	40mm	1,2mm	0,141kg	CC-C5-050-40-HDG	27,75€	CC-C5-050-40-PG	20,55€
100mm	40mm	1,2mm	0,251kg	CC-C5-100-40-HDG	30,35€	CC-C5-100-40-PG	22,45€
150mm	40mm	1,2mm	0,393kg	CC-C5-150-40-HDG	32,30€	CC-C5-150-40-PG	23,90€
200mm	40mm	1,2mm	0,565Kg	CC-C5-200-40-HDG	34,65€	CC-C5-200-40-PG	25,65€
300mm	40mm	1,2mm	1,0005kg	CC-C5-300-40-HDG	49,10€	CC-C5-300-40-PG	36,35€
50mm	50mm	1,2mm	0,161kg	CC-C5-050-50-HDG	27,80€	CC-C5-050-50-PG	20,60€
100mm	60mm	1,2mm	0,332kg	CC-C5-100-60-HDG	30,40€	CC-C5-100-60-PG	22,60€
150mm	60mm	1,2mm	0,492kg	CC-C5-150-60-HDG	32,40€	CC-C5-150-60-PG	23,95€
200mm	60mm	1,2mm	0,684kg	CC-C5-200-60-HDG	34,70€	CC-C5-200-60-PG	25,70€
300mm	60mm	1,2mm	1,161Kg	CC-C5-300-60-HDG	49,15€	CC-C5-300-60-PG	36,50€
400mm	60mm	1,2mm	2,205kg	CC-C5-400-60-HDG	56,10€	CC-C5-400-60-PG	41,55€
500mm	60mm	1,2mm	3,116Kg	CC-C5-500-60-HDG	64,70€	CC-C5-500-60-PG	47,90€
600mm	60mm	1,2mm	5,020Kg	CC-C5-600-60-HDG	84,65€	CC-C5-600-60-PG	62,70€
100mm	100mm	1,2mm	0,492kg	CC-C5-100-100-HDG	41,40€	CC-C5-100-100-PG	29,95€
200mm	100mm	1,2mm	0,784kg	CC-C5-200-100-HDG	44,70€	CC-C5-200-100-PG	29,70€
300mm	100mm	1,2mm	1,221Kg	CC-C5-300-100-HDG	56,15€	CC-C5-300-100-PG	39,50€
400mm	100mm	1,2mm	2,405kg	CC-C5-400-100-HDG	66,10€	CC-C5-400-100-PG	46,55€
500mm	100mm	1,2mm	3,316Kg	CC-C5-500-100-HDG	78,70€	CC-C5-500-100-PG	54,90€
600mm	100mm	1,2mm	5,320Kg	CC-C5-600-100-HDG	99,65€	CC-C5-600-100-PG	69,70€

- Artigo de stock habitual
- Artigo disponível por encomenda

**Tampa P/ Curva Plana P/ Caminho Cabos**  
**Acabamento: Sendzimir - EN 10346**  
**Acabamento: Galvanizado a Quente - EN 1461**

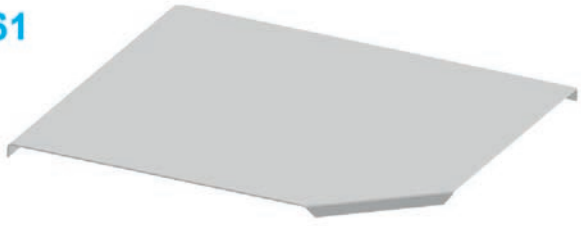
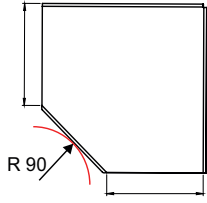

mm	mm	kg	Código (Galvanizado Quente)	P.U. €	Código (Sendzimir)	P.U. €
50mm	1,0mm	0,120kg	CC-TP-C5-050-HDG	9,45€	CC-TP-C5-050-PG	7,00€
100mm	1,0mm	0,250kg	CC-TP-C5-100-HDG	10,95€	CC-TP-C5-100-PG	8,10€
150mm	1,0mm	0,460kg	CC-TP-C5-150-HDG	14,45€	CC-TP-C5-150-PG	10,70€
200mm	1,0mm	0,640kg	CC-TP-C5-200-HDG	16,00€	CC-TP-C5-200-PG	11,80€
300mm	1,0mm	1,200kg	CC-TP-C5-300-HDG	24,85€	CC-TP-C5-300-PG	18,40€
400mm	1,0mm	2,440kg	CC-TP-C5-400-HDG	32,60€	CC-TP-C5-400-PG	24,10€
500mm	1,0mm	3,610kg	CC-TP-C5-500-HDG	36,10€	CC-TP-C5-500-PG	26,70€
600mm	1,0mm	4,960kg	CC-TP-C5-600-HDG	45,85€	CC-TP-C5-600-PG	31,00€

- Artigo de stock habitual
- Artigo disponível por encomenda

### Tê Plano para Caminho Cabos Acabamento: Sendzimir - EN 10346

### Acabamento: Galvanizado a Quente - EN 1461

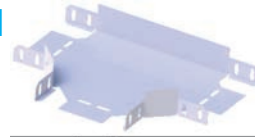
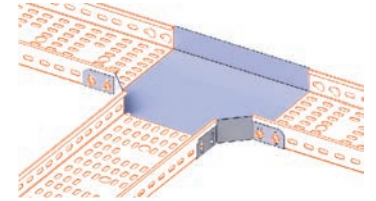
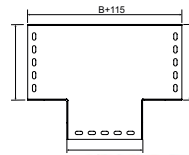

mm K	mm H	mm K	kg	Código (Galvanizado Quente)	P.U. €		Código (Sendzimir)	P.U. €	
50mm	40mm	1,2mm	0,160kg	CC-T2-050-40-HDG	38,75€	●	CC-T2-050-40-PG	28,70€	●
100mm	40mm	1,2mm	0,276kg	CC-T2-100-40-HDG	42,00€	●	CC-T2-100-40-PG	31,10€	●
150mm	40mm	1,2mm	0,424kg	CC-T2-150-40-HDG	46,65€	●	CC-T2-150-40-PG	34,55€	●
200mm	40mm	1,2mm	0,603Kg	CC-T2-200-40-HDG	51,10€	●	CC-T2-200-40-PG	37,80€	●
300mm	40mm	1,2mm	1,055kg	CC-T2-300-40-HDG	70,40€	●	CC-T2-300-40-PG	52,15€	●
50mm	50mm	1,2mm	0,171kg	CC-T2-050-50-HDG	41,10€	●	CC-T2-050-50-PG	30,40€	●
100mm	60mm	1,2mm	0,361kg	CC-T2-100-60-HDG	42,00€	●	CC-T2-100-60-PG	31,10€	●
150mm	60mm	1,2mm	0,528kg	CC-T2-150-60-HDG	46,65€	●	CC-T2-150-60-PG	34,55€	●
200mm	60mm	1,2mm	0,725kg	CC-T2-200-60-HDG	51,10	●	CC-T2-200-60-PG	37,80€	●
300mm	60mm	1,2mm	1,215Kg	CC-T2-300-60-HDG	67,30€	●	CC-T2-300-60-PG	49,85€	●
400mm	60mm	1,2mm	2,288kg	CC-T2-400-60-HDG	92,65€	●	CC-T2-400-60-PG	68,60€	●
500mm	60mm	1,2mm	3,215Kg	CC-T2-500-60-HDG	94,95€	●	CC-T2-500-60-PG	70,30€	●
600mm	60mm	1,2mm	5,157Kg	CC-T2-600-60-HDG	116,10€	●	CC-T2-600-60-PG	86,00€	●
100mm	100mm	1,2mm	0,528kg	CC-T2-100-100-HDG	54,65€	●	CC-T2-100-100-PG	37,55€	●
200mm	100mm	1,2mm	0,785kg	CC-T2-200-100-HDG	58,10	●	CC-T2-200-100-PG	40,80€	●
300mm	100mm	1,2mm	1,315Kg	CC-T2-300-100-HDG	80,30€	●	CC-T2-300-100-PG	55,85€	●
400mm	100mm	1,2mm	2,488kg	CC-T2-400-100-HDG	105,65€	●	CC-T2-400-100-PG	73,60€	●
500mm	100mm	1,2mm	3,355Kg	CC-T2-500-100-HDG	111,95€	●	CC-T2-500-100-PG	78,30€	●
600mm	100mm	1,2mm	5,287Kg	CC-T2-600-100-HDG	133,10€	●	CC-T2-600-100-PG	93,00€	●

### Tampa P/ Tê Plano para Caminho Cabos

### Acabamento: Sendzimir - EN 10346

### Acabamento: Galvanizado a Quente - EN 1461

- Artigo de stock habitual
- Artigo disponível por encomenda

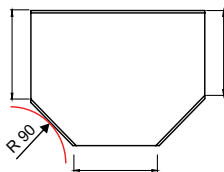

mm K	mm K	kg	Código (Galvanizado Quente)	P.U. €		Código (Sendzimir)	P.U. €	
50mm	1,0mm	0,140kg	CC-TP-T2-050-HDG	7,30€	●	CC-TP-T2-050-PG	5,40€	●
100mm	1,0mm	0,290kg	CC-TP-T2-100-HDG	8,35€	●	CC-TP-T2-100-PG	6,15€	●
150mm	1,0mm	0,530kg	CC-TP-T2-150-HDG	11,45€	●	CC-TP-T2-150-PG	8,45€	●
200mm	1,0mm	0,780kg	CC-TP-T2-200-HDG	12,80€	●	CC-TP-T2-200-PG	9,45€	●
300mm	1,0mm	1,360kg	CC-TP-T2-300-HDG	16,50€	●	CC-TP-T2-300-PG	12,20€	●
400mm	1,0mm	2,720kg	CC-TP-T2-400-HDG	22,85€	●	CC-TP-T2-400-PG	16,90€	●
500mm	1,0mm	3,980kg	CC-TP-T2-500-HDG	25,60€	●	CC-TP-T2-500-PG	18,95€	●
600mm	1,0mm	5,470kg	CC-TP-T2-600-HDG	31,95€	●	CC-TP-T2-600-PG	23,65€	●

- Artigo de stock habitual
- Artigo disponível por encomenda

# Cruzamento Plano para Caminho Cabos

Acabamento: Sendzimir - EN 10346  
Acabamento: Galvanizado a Quente - EN 1461

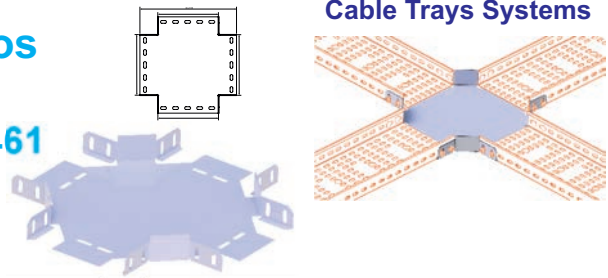

mm ↔	mm ↑	mm ↔	kg	Código (Galvanizado Quente)	P.U. €		Código (Sendzimir)	P.U. €	
50mm	40mm	1,2mm	0,180kg	CC-X1-050-40-HDG	57,40€	●	CC-X1-050-40-PG	42,50€	●
100mm	40mm	1,2mm	0,304kg	CC-X1-100-40-HDG	61,90€	●	CC-X1-100-40-PG	45,80€	●
150mm	40mm	1,2mm	0,458kg	CC-X1-150-40-HDG	63,95€	●	CC-X1-150-40-PG	47,35€	●
200mm	40mm	1,2mm	0,643Kg	CC-X1-200-40-HDG	66,30€	●	CC-X1-200-40-PG	49,10€	●
300mm	40mm	1,2mm	1,108kg	CC-X1-300-40-HDG	80,90€	●	CC-X1-300-40-PG	59,90€	●
50mm	50mm	1,2mm	0,192g	CC-X1-050-50-HDG	60,70€	●	CC-X1-050-50-PG	44,95€	●
100mm	60mm	1,2mm	0,393kg	CC-X1-100-60-HDG	61,90€	●	CC-X1-100-60-PG	45,80€	●
150mm	60mm	1,2mm	0,565kg	CC-X1-150-60-HDG	63,95€	●	CC-X1-150-60-PG	47,35€	●
200mm	60mm	1,2mm	0,769kg	CC-X1-200-60-HDG	66,30€	●	CC-X1-200-60-PG	49,10€	●
300mm	60mm	1,2mm	1,272Kg	CC-X1-300-60-HDG	80,90€	●	CC-X1-300-60-PG	59,90€	●
400mm	60mm	1,2mm	2,375kg	CC-X1-400-60-HDG	120,70€	●	CC-X1-400-60-PG	89,40€	●
500mm	60mm	1,2mm	3,317Kg	CC-X1-500-60-HDG	129,35€	●	CC-X1-500-60-PG	95,80€	●
600mm	60mm	1,2mm	5,299Kg	CC-X1-600-60-HDG	158,10€	●	CC-X1-600-60-PG	117,10€	●
100mm	100mm	1,2mm	0,585kg	CC-X1-100-100-HDG	70,95€	●	CC-X1-100-100-PG	49,35€	●
200mm	100mm	1,2mm	0,819kg	CC-X1-200-100-HDG	75,30€	●	CC-X1-200-100-PG	53,10€	●
300mm	100mm	1,2mm	1,372Kg	CC-X1-300-100-HDG	89,90€	●	CC-X1-300-100-PG	64,90€	●
400mm	100mm	1,2mm	2,485kg	CC-X1-400-100-HDG	130,70€	●	CC-X1-400-100-PG	94,40€	●
500mm	100mm	1,2mm	3,437Kg	CC-X1-500-100-HDG	141,35€	●	CC-X1-500-100-PG	99,80€	●
600mm	100mm	1,2mm	5,505Kg	CC-X1-600-100-HDG	173,10€	●	CC-X1-600-100-PG	123,10€	●

- Artigo de stock habitual
- Artigo disponível por encomenda

# Tampa P/ Cruzamento Plano para Caminho Cabos

Acabamento: Sendzimir - EN 10346  
Acabamento: Galvanizado a Quente - EN 1461

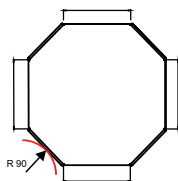

mm ↔	mm ↔	kg	Código (Galvanizado Quente)	P.U. €		Código (Sendzimir)	P.U. €	
50mm	1,0mm	0,170kg	CC-TP-X1-050-HDG	21,75€	●	CC-TP-X1-050-PG	16,10€	●
100mm	1,0mm	0,340kg	CC-TP-X1-100-HDG	24,10€	●	CC-TP-X1-100-PG	17,85€	●
150mm	1,0mm	0,600kg	CC-TP-X1-150-HDG	26,40€	●	CC-TP-X1-150-PG	19,55€	●
200mm	1,0mm	0,810kg	CC-TP-X1-200-HDG	28,85€	●	CC-TP-X1-200-PG	21,35€	●
300mm	1,0mm	1,470kg	CC-TP-X1-300-HDG	36,70€	●	CC-TP-X1-300-PG	27,90€	●
400mm	1,0mm	2,900kg	CC-TP-X1-400-HDG	49,75€	●	CC-TP-X1-400-PG	36,85€	●
500mm	1,0mm	4,190kg	CC-TP-X1-500-HDG	59,95€	●	CC-TP-X1-500-PG	43,65€	●
600mm	1,0mm	5,730kg	CC-TP-X1-600-HDG	61,85€	●	CC-TP-X1-600-PG	45,80€	●

- Artigo de stock habitual
- Artigo disponível por encomenda

## Redução para Caminho Cabos

### Acabamento: Sendzimir - EN 10346

### Acabamento: Galvanizado a Quente - EN 1461

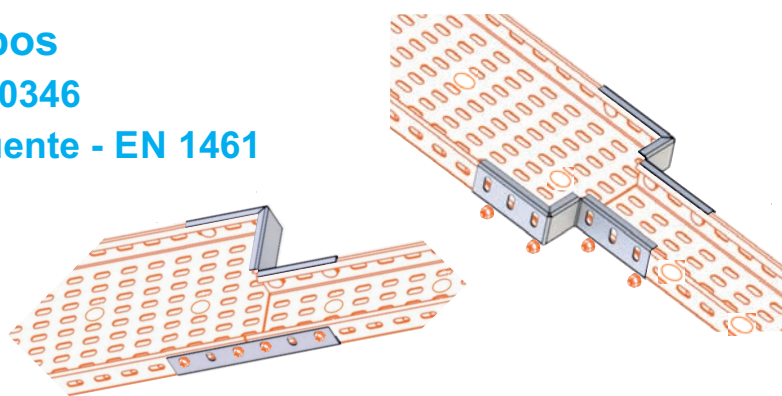
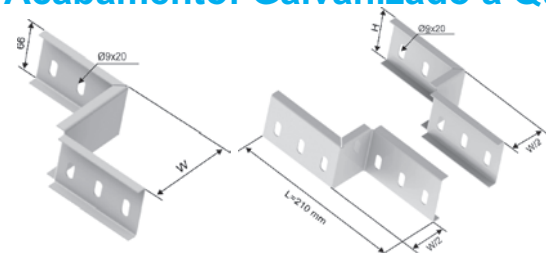

mm	mm	mm	kg	Código (Galvanizado Quente)	P.U. €		Código (Sendzimir)	P.U. €	
50mm	40mm	1,2mm	0,175kg	CC-RD-050-40-HDG	13,75€	●	CC-RD-050-40-PG	7,20€	●
50mm	60mm	1,2mm	0,350kg	CC-RD-050-60-HDG	15,50€	●	CC-RD-050-60-PG	7,75€	●
100mm	40mm	1,2mm	0,215kg	CC-RD-100-40-HDG	14,00€	●	CC-RD-100-40-PG	7,20€	●
100mm	60mm	1,2mm	0,285Kg	CC-RD-100-60-HDG	15,50€	●	CC-RD-100-60-PG	7,75€	●
200mm	60mm	1,2mm	0,380kg	CC-RD-200-60-HDG	18,80€	●	CC-RD-200-60-PG	9,45€	●
100mm	100mm	1,2mm	0,305Kg	CC-RD-100-100-HDG	200,20€	●	CC-RD-100-100-PG	9,75€	●
200mm	100mm	1,2mm	0,410kg	CC-RD-200-100-HDG	24,80€	●	CC-RD-200-100-PG	11,45€	●

## Topo para Caminho Cabos

### Acabamento: Sendzimir - EN 10346

### Acabamento: Galvanizado a Quente - EN 1461

- Artigo de stock habitual
- Artigo disponível por encomenda

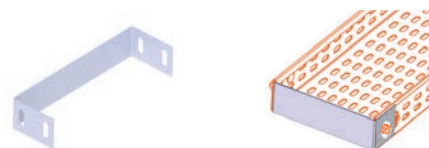
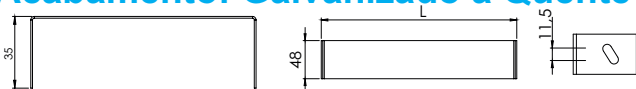

mm	mm	mm	kg	Código (Galvanizado Quente)	P.U. €		Código (Sendzimir)	P.U. €	
50mm	40mm	1,2mm	0,055kg	CC-TO-050-40-HDG	6,50€	●	CC-TO-050-40-PG	4,80€	●
100mm	40mm	1,2mm	0,060kg	CC-TO-100-40-HDG	7,30€	●	CC-TO-100-40-PG	5,40€	●
150mm	40mm	1,2mm	0,080kg	CC-TO-150-40-HDG	8,30€	●	CC-TO-150-40-PG	6,13€	●
200mm	40mm	1,2mm	0,115Kg	CC-TO-200-40-HDG	8,65€	●	CC-TO-200-40-PG	6,40€	●
300mm	40mm	1,2mm	0,140kg	CC-TO-300-40-HDG	10,10€	●	CC-TO-300-40-PG	7,45€	●
50mm	50mm	1,2mm	0,050Kg	CC-TO-050-50-HDG	6,95€	●	CC-TO-050-50-PG	5,15€	●
100mm	60mm	1,2mm	0,110kg	CC-TO-100-60-HDG	7,30€	●	CC-TO-100-60-PG	5,40€	●
150mm	60mm	1,2mm	0,125kg	CC-TO-150-60-HDG	8,30€	●	CC-TO-150-60-PG	6,15€	●
200mm	60mm	1,2mm	0,165kg	CC-TO-200-60-HDG	8,65€	●	CC-TO-200-60-PG	6,40€	●
300mm	60mm	1,2mm	0,220kg	CC-TO-300-60-HDG	10,10€	●	CC-TO-300-60-PG	7,45€	●
400mm	60mm	1,2mm	0,275kg	CC-TO-400-60-HDG	11,55€	●	CC-TO-400-60-PG	8,55€	●
500mm	60mm	1,2mm	0,325kg	CC-TO-500-60-HDG	13,00€	●	CC-TO-500-60-PG	9,60€	●
600mm	60mm	1,2mm	0,380kg	CC-TO-600-60-HDG	15,00€	●	CC-TO-600-60-PG	11,10€	●
100mm	100mm	1,2mm	0,150kg	CC-TO-100-100-HDG	10,00€	●	CC-TO-100-100-PG	7,50€	●
200mm	100mm	1,2mm	0,190kg	CC-TO-200-100-HDG	10,80€	●	CC-TO-200-100-PG	8,00€	●
300mm	100mm	1,2mm	0,220kg	CC-TO-300-100-HDG	12,60€	●	CC-TO-300-100-PG	9,30€	●
400mm	100mm	1,2mm	0,275kg	CC-TO-400-100-HDG	14,90€	●	CC-TO-400-100-PG	10,55€	●
500mm	100mm	1,2mm	0,325kg	CC-TO-500-100-HDG	16,40€	●	CC-TO-500-100-PG	11,60€	●
600mm	100mm	1,2mm	0,380kg	CC-TO-600-100-HDG	18,00€	●	CC-TO-600-100-PG	12,60€	●

- Artigo de stock habitual
- Artigo disponível por encomenda



## Separador para Caminho Cabos

Acabamento: Sendzimir - EN 10346  
Acabamento: Galvanizado a Quente - EN 1461

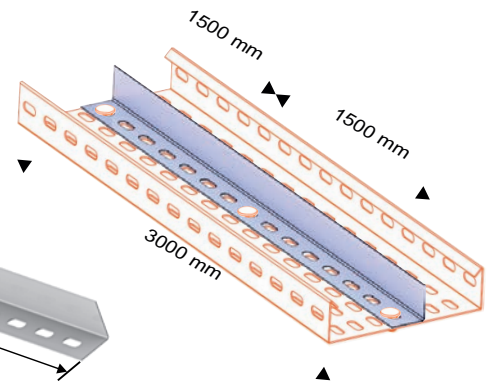
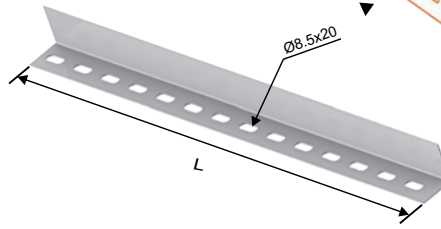
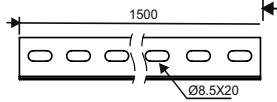
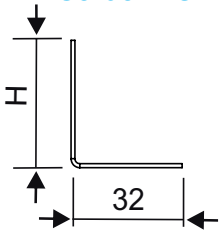

mm	mm	mm	kg	Código (Galvanizado Quente)	P.U./mt €	Código (Sendzimir)	P.U./mt €
40mm	0,8mm	3000mm	0,560kg	CC-SP-040-08-HDG	8,10€	CC-SP-040-08-PG	5,95€
60mm	0,8mm	3000mm	0,730kg	CC-SP-060-08-HDG	8,45€	CC-SP-060-08-PG	6,25€
100mm	0,8mm	3000mm	1,060kg	CC-SP-100-08-HDG	11,50€	CC-SP-100-08-PG	8,50€
mm	mm	mm	kg	Código (Inox 304)		P.U./mt €	
60mm	0,8mm	3000mm	0,730kg	CC-SP-060-08-HDG		12,00€	

## Descida de Cabos para Caminho Cabos

Acabamento: Sendzimir - EN 10346  
Acabamento: Galvanizado a Quente - EN 1461

- Artigo de stock habitual
- Artigo disponível por encomenda

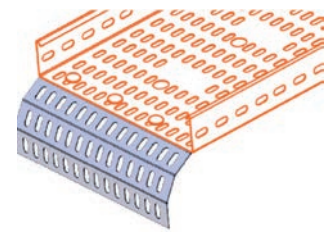
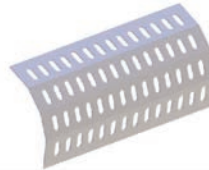
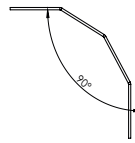
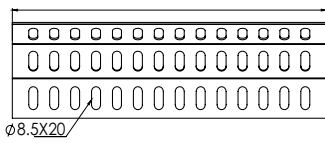

mm	mm	kg	Código (Galvanizado Quente)	P.U. €	Código (Sendzimir)	P.U. €
50mm	1,5mm	0,070kg	CC-DES-050-HDG	9,50€	CC-DES-050-PG	7,10€
100mm	1,5mm	0,145kg	CC-DES-100-HDG	18,40€	CC-DES-100-PG	13,60€
150mm	1,5mm	0,220kg	CC-DES-150-HDG	28,65€	CC-DES-150-PG	21,20€
200mm	1,5mm	0,290kg	CC-DES-200-HDG	36,80€	CC-DES-200-PG	27,25€
300mm	1,5mm	0,435kg	CC-DES-300-HDG	55,30€	CC-DES-300-PG	40,95€
400mm	2,0mm	0,775kg	CC-DES-400-HDG	73,45€	CC-DES-400-PG	54,40€
500mm	2,0mm	0,970kg	CC-DES-500-HDG	91,60€	CC-DES-500-PG	67,85€
600mm	2,0mm	1,160kg	CC-DES-600-HDG	110,60€	CC-DES-600-PG	81,90€

- Artigo de stock habitual
- Artigo disponível por encomenda

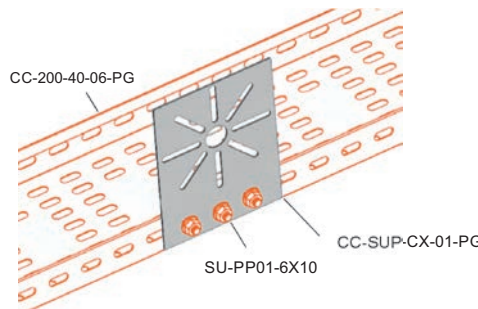
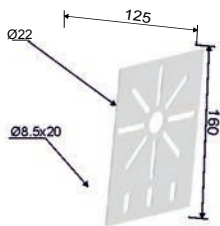

mm	mm	mm	kg	Código (Galvanizado Quente)	P.U. €	Código (Sendzimir)	P.U. €
160mm	125mm	1,5mm	0,20kg	CC-SUP-CX-01-HDG	4,50€	CC-SUP-CX-01-PG	3,35€
mm	mm	mm	kg	Código (Inox 304)		P.U. €	
160mm	125mm	1,5mm	0,20kg	CC-SUP-CX-01-SS304		8,00€	

- Artigo de stock habitual
- Artigo disponível por encomenda

## Caminho Cabos de Varão Eletrosoldado com Aba 35mm

Acabamento: Eletrozincado - EN 2081  
Acabamento: Galvanizado a Quente - EN 1461

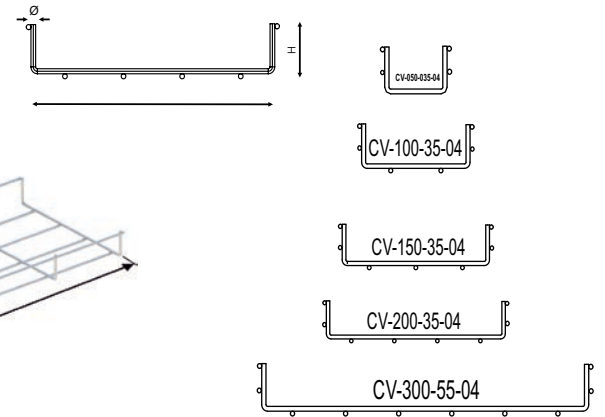
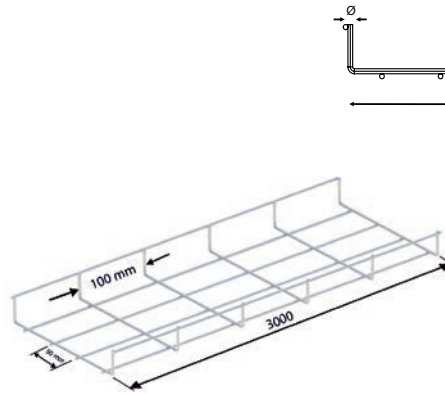
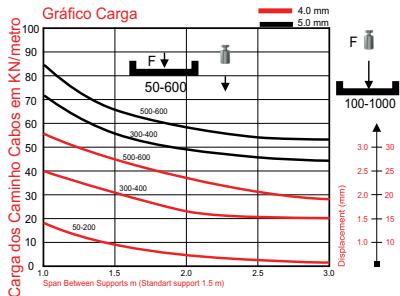

mm	mm	mm	mm	kg/mt	Código(Galvanizado Quente)	P.U./mt €		Código(Eletrozincado)	P.U./mt €	
50mm	35mm	4,0mm	3000mm	0,760kg/mt	CV-050-35-04-HDG	8,16€	●	CV-050-35-04-EG	6,53€	●
100mm	35mm	4,0mm	3000mm	1,080kg/mt	CV-100-35-04-HDG	8,50€	●	CV-100-35-04-EG	6,13€	●
150mm	35mm	4,0mm	3000mm	1,330kg/mt	CV-150-35-04-HDG	9,20€	●	CV-150-35-04-EG	6,97€	●
200mm	35mm	4,0mm	3000mm	1,580kg/mt	CV-200-35-04-HDG	9,78€	●	CV-200-35-04-EG	7,83€	●
300mm	35mm	4,0mm	3000mm	2,090kg/mt	CV-300-35-04-HDG	13,10€	●	CV-300-35-04-EG	10,53€	●

- Artigo de stock habitual
- Artigo disponível por encomenda

## Caminho Cabos de Varão Eletrosoldado com Aba 55mm

Acabamento: Eletrozincado - EN 2081  
Acabamento: Galvanizado a Quente - EN 1461

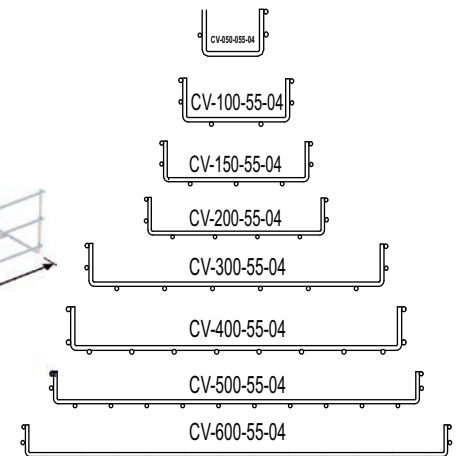
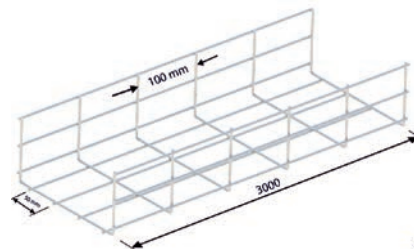
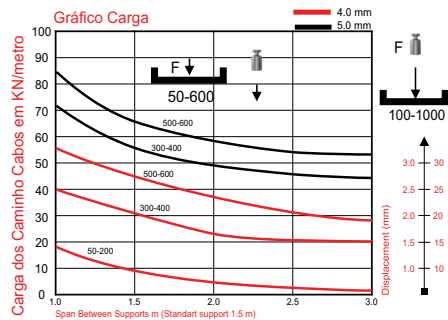

mm	mm	mm	mm	kg/mt	Código(Galvanizado Quente)	P.U./mt €		Código(Eletrozincado)	P.U./mt €	
50mm	55mm	4,0mm	3000mm	0,855g/mt	CV-050-55-04-HDG	8,30€	●	CV-050-55-04-EG	6,12€	●
100mm	55mm	4,0mm	3000mm	1,170kg/mt	CV-100-55-04-HDG	8,90€	●	CV-100-55-04-EG	6,50€	●
150mm	55mm	4,0mm	3000mm	1,420kg/mt	CV-150-55-04-HDG	9,45€	●	CV-150-55-04-EG	7,25€	●
200mm	55mm	4,0mm	3000mm	1,680kg/mt	CV-200-55-04-HDG	11,10€	●	CV-200-55-04-EG	8,85€	●
300mm	55mm	4,0mm	3000mm	2,180kg/mt	CV-300-55-04-HDG	13,55€	●	CV-300-55-04-EG	10,85€	●
400mm	55mm	4,0mm	3000mm	2,680kg/mt	CV-400-55-04-HDG	24,80€	●	CV-400-55-04-EG	16,75€	●
500mm	55mm	4,0mm	3000mm	3,180kg/mt	CV-500-55-04-HDG	30,85€	●	CV-500-55-04-EG	20,40€	●
600mm	55mm	4,0mm	3000mm	3,690kg/mt	CV-600-55-04-HDG	31,50€	●	CV-600-55-04-EG	22,20€	●

- Artigo de stock habitual
- Artigo disponível por encomenda

# Caminho Cabos de Varão Eletrosoldado com Aba 100mm

Acabamento: Eletrozincado - EN 2081

Acabamento: Galvanizado a Quente - EN 1461

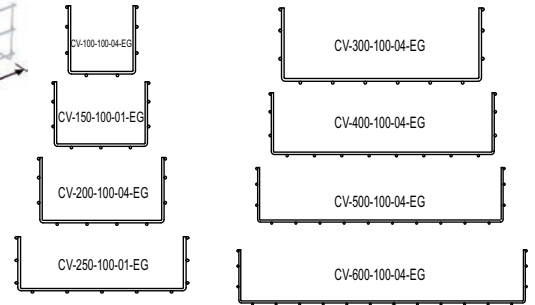
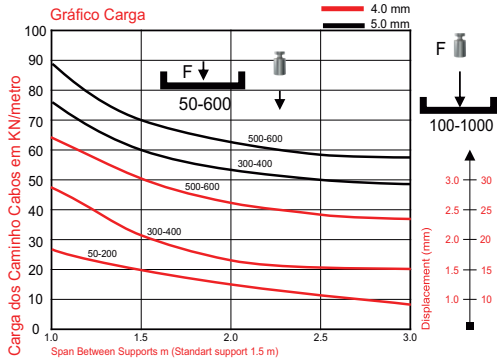
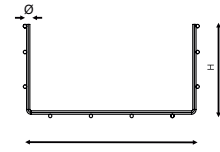

mm	mm	mm	mm	kg/mt	Código (Galvanizado Quente)	P.U./mt €	Código (Electrozincado)	P.U./mt €
100mm	100mm	4,0mm	3000mm	1,170kg/mt	CV-100-100-04-HDG	15,50€	CV-100-100-04-EG	11,50€
150mm	100mm	4,0mm	3000mm	1,420kg/mt	CV-150-100-04-HDG	16,50€	CV-150-100-04-EG	12,00€
200mm	100mm	4,0mm	3000mm	1,680kg/mt	CV-200-100-04-HDG	17,90€	CV-200-100-04-EG	13,50€
300mm	100mm	4,0mm	3000mm	2,180kg/mt	CV-300-100-04-HDG	19,95€	CV-300-100-04-EG	15,50€
400mm	100mm	4,0mm	3000mm	2,680kg/mt	CV-400-100-04-HDG	29,85€	CV-400-100-04-EG	23,50€
500mm	100mm	4,0mm	3000mm	3,180kg/mt	CV-500-100-04-HDG	30,90€	CV-500-100-04-EG	28,00€
600mm	100mm	4,0mm	3000mm	3,690kg/mt	CV-600-100-04-HDG	36,80€	CV-600-100-04-EG	30,50€

- Artigo de stock habitual
- Artigo disponível por encomenda

# Tampa para Caminho Cabos / Calha Varão

Acabamento: Sendzimir - EN 2081

Acabamento: Galvanizado a Quente - EN 1461

Tampa de Encaixe por pressão,  
Não necessita de Clip fixação

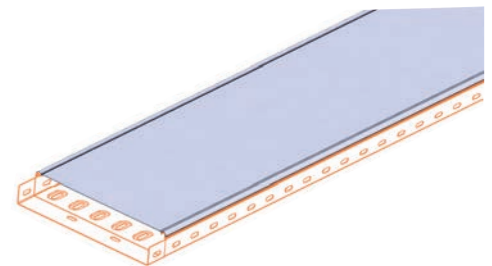
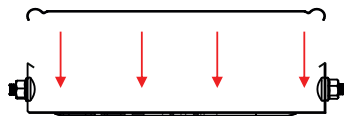

mm	mm	mm	kg/mt	Código(Galvanizado Quente)	P.U./mt €	Código(Sendzimir)	P.U./mt €
50mm	0,6mm	3000mm	0,270kg/mt	CV-TP-050-07-HDG(p/Cam.Cabos de Varão)	4,42€	CV-TP-050-06-PG(p/Cam.Cabos Varão)	2,55€
50mm	0,6mm	3000mm	0,270kg/mt	CC-TP-050-07-HDG	4,42€	CC-TP-050-06-PG	2,55€
100mm	0,6mm	3000mm	0,470kg/mt	CC-TP-100-07-HDG	6,32€	CC-TP-100-06-PG	3,99€
150mm	0,6mm	3000mm	0,660kg/mt	CC-TP-150-07-HDG	8,50€	CC-TP-150-06-PG	5,45€
200mm	0,7mm	3000mm	1,030kg/mt	CC-TP-200-08-HDG	10,75€	CC-TP-200-07-PG	6,91€
300mm	0,8mm	3000mm	1,750kg/mt	CC-TP-300-08-HDG	19,50€	CC-TP-300-08-PG	12,68€
400mm	0,8mm	3000mm	2,300kg/mt	CC-TP-400-08-HDG	25,30€	CC-TP-400-08-PG	16,49€
500mm	1,0mm	3000mm	3,670kg/mt	CC-TP-500-10-HDG	38,50€	CC-TP-500-10-PG	25,11€
600mm	1,0mm	3000mm	4,380kg/mt	CC-TP-600-10-HDG	45,60€	CC-TP-600-10-PG	29,95€

- Artigo de stock habitual
- Artigo disponível por encomenda

## Caminho Cabos de Varão Inox com Aba 35mm Acabamento: Inox ( 316 / 304 )

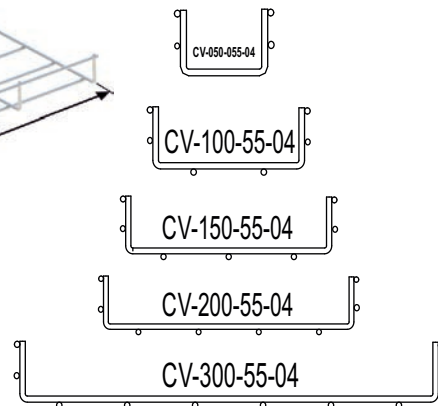
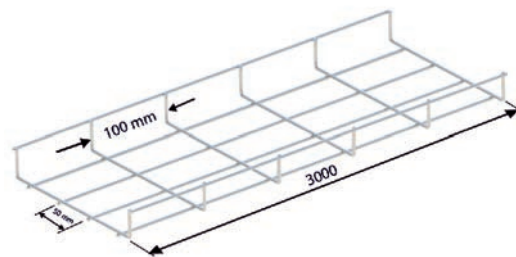
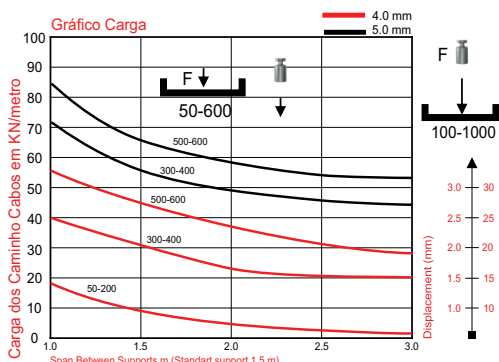
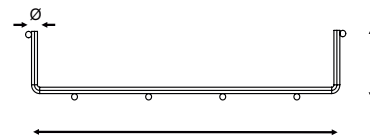

mm	mm	mm	mm	kg/mt	Código (Inox 316)	P.U./mt €	Código (Inox 304)	P.U./mt €
50mm	35mm	4,0mm	3000mm	0,760kg/mt	CV-050-35-04-SS316	30,04€	CV-050-35-04-SS304	16,50€
100mm	35mm	4,0mm	3000mm	1,080kg/mt	CV-100-35-04-SS316	42,55€	CV-100-35-04-SS304	18,50€
150mm	35mm	4,0mm	3000mm	1,330kg/mt	CV-150-35-04-SS316	48,80€	CV-150-35-04-SS304	19,90€
200mm	35mm	4,0mm	3000mm	1,580kg/mt	CV-200-35-04-SS316	53,90€	CV-200-35-04-SS304	22,34€
300mm	35mm	4,0mm	3000mm	2,090kg/mt	CV-300-35-04-SS316	68,20€	CV-300-35-04-SS304	35,40€

- Artigo de stock habitual
- Artigo disponível por encomenda

## Caminho Cabos de Varão Inox com Aba 55mm Acabamento: Inox ( 316 / 304 )

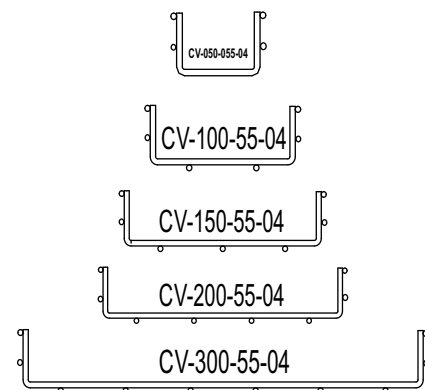
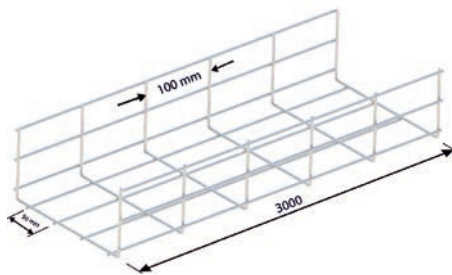
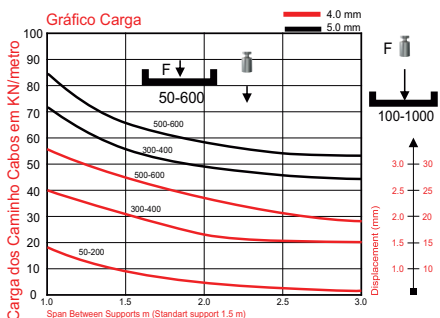

mm	mm	mm	mm	kg/mt	Código (Inox 316)	P.U./mt €	Código (Inox 304)	P.U./mt €
50mm	55mm	3000mm	4,0mm	0,855g/mt	CV-050-55-04-SS316	33,50€	CV-050-55-04-SS304	18,10€
100mm	55mm	3000mm	4,0mm	1,170kg/mt	CV-100-55-04-SS316	45,30€	CV-100-55-04-SS304	22,50€
150mm	55mm	3000mm	4,0mm	1,420kg/mt	CV-150-55-04-SS316	49,50€	CV-150-55-04-SS304	26,60€
200mm	55mm	3000mm	4,0mm	1,680kg/mt	CV-200-55-04-SS316	55,60€	CV-200-55-04-SS304	34,40€
300mm	55mm	3000mm	4,0mm	2,180kg/mt	CV-300-55-04-SS316	72,80€	CV-300-55-04-SS304	44,30€
400mm	55mm	3000mm	4,0mm	2,580kg/mt	CV-400-55-04-SS316	85,90€	CV-400-55-04-SS304	54,65€
500mm	55mm	3000mm	4,0mm	3,180kg/mt	CV-500-55-04-SS316	125,30€	CV-500-55-04-SS304	66,09€
600mm	55mm	3000mm	4,0mm	3,690kg/mt	CV-600-55-04-SS316	150,00€	CV-600-55-04-SS304	81,14€

- Artigo de stock habitual
- Artigo disponível por encomenda

## Tampa para Caminho Cabos / Calha Varão Inox

Acabamento: Inox ( 316 / 304 )

Tampa de Encaixe por pressão,  
Não necessita de Clip fixação

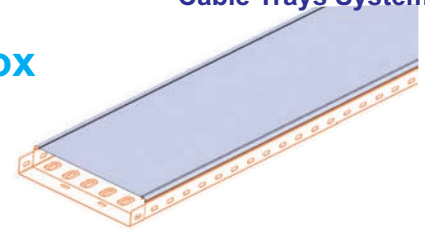
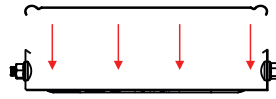

mm	mm	mm	kg/mt	Código (Inox 316)	P.U./mt €	Código (Inox 304)	P.U./mt €
50mm	0,6mm	3000mm	0,270kg/mt	CC-TP-050-06-SS316	25,50€	CC-TP-050-06-SS304	17,25€
100mm	0,6mm	3000mm	0,470kg/mt	CC-TP-100-06-SS316	30,70€	CC-TP-100-06-SS304	19,50€
150mm	0,5mm	3000mm	0,660kg/mt	CC-TP-150-06-SS316	39,80€	CC-TP-150-06-SS304	27,80€
200mm	0,7mm	3000mm	1,030kg/mt	CC-TP-200-07-SS316	49,61€	CC-TP-200-07-SS304	32,30€
300mm	0,8mm	3000mm	1.750kg/mt	CC-TP-300-08-SS316	90,04€	CC-TP-300-08-SS304	53,80€
400mm	0,9mm	3000mm	2,840kg/mt	CC-TP-400-09-SS316	120,95€	CC-TP-400-09-SS304	82,76€
500mm	0,9mm	3000mm	4,610kg/mt	CC-TP-500-09-SS316	150,80€	CC-TP-500-09-SS304	120,95€
600mm	0,9mm	3000mm	5,500kg/mt	CC-TP-600-09-SS316	190,85€	CC-TP-600-09-SS304	150,80€

- Artigo de stock habitual
- Artigo disponível por encomenda

## Perfil Lateral p/Cabos de Escada Modular

Acabamento: Sendzimir - EN 10346  
Acabamento: Galvanizado a Quente - EN EN 1461

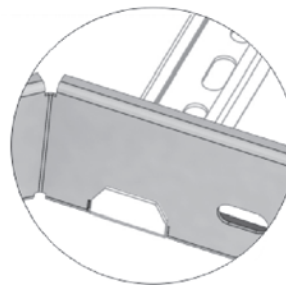
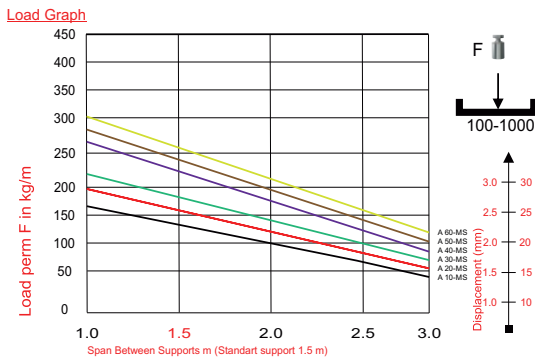
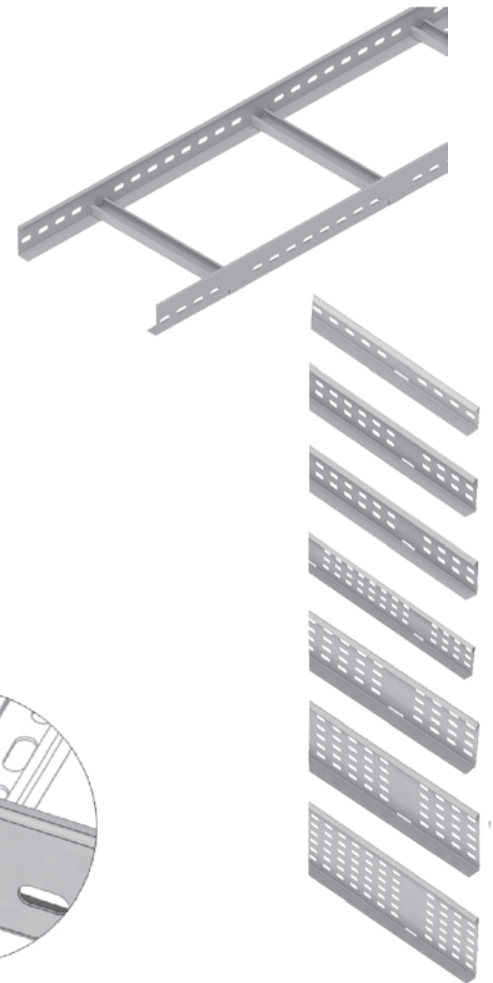
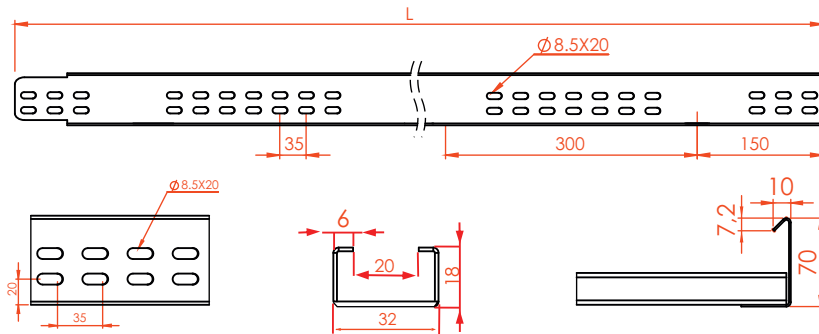

mm	mm	mm	kg/mt	Código (Galvanizado Quente)	P.U./mt €	Código (Sendzimir)	P.U./mt €
60mm	1,0mm	3000mm	0,765kg/mt	CE-PER-060-10-HDG	9,68€/mt	CE-PER-060-10-PG	7,15€/mt
100mm	1,0mm	3000mm	0,920kg/mt	CE-PER-100-10-HDG	13,30€/mt	CE-PER-100-10-PG	9,85€/mt

- Artigo de stock habitual
- Artigo disponível por encomenda

## Degraus para Caminho Cabos de Escada Modular

Acabamento: Sendzimir - EN 10346

Acabamento: Galvanizado a Quente - EN EN 1461

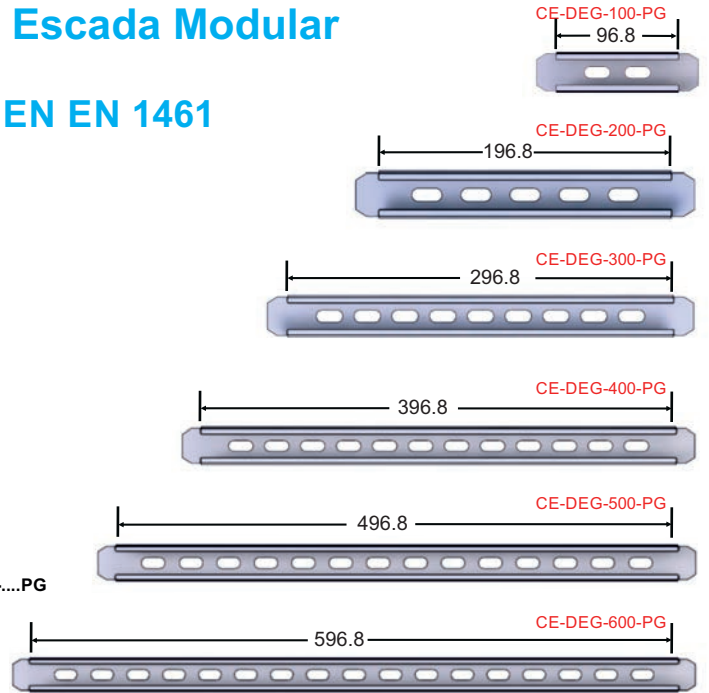
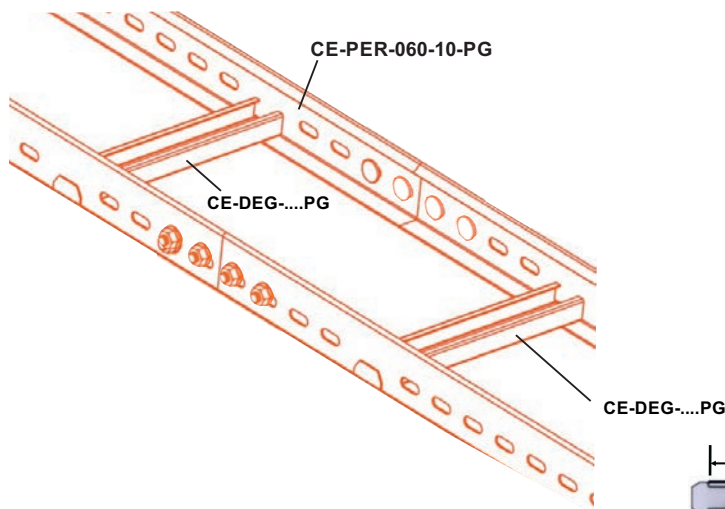

mm	mm	mm	mm	kg	Código (Galvanizado Quente)	P.U. €		Código (Sendzimir)	P.U. €	
32mm	32mm	1,0mm	196,8mm	0,120kg	CE-DEG-200-HDG	2,00€	●	CE-DEG-200-PG	1,45€	●
32mm	32mm	1,0mm	298,8mm	0,170kg	CE-DEG-300-HDG	2,60€	●	CE-DEG-300-PG	1,90€	●
32mm	32mm	1,0mm	396,8mm	0,260kg	CE-DEG-400-HDG	4,00€	●	CE-DEG-400-PG	2,95€	●
32mm	32mm	1,0mm	496,8mm	0,320kg	CE-DEG-500-HDG	4,95€	●	CE-DEG-500-PG	3,65€	●
32mm	32mm	1,0mm	296,8mm	0,400kg	CE-DEG-600-HDG	5,75€	●	CE-DEG-600-PG	4,25€	●

- Artigo de stock habitual
- Artigo disponível por encomenda

## União Reta / Angular p/ Cabos de Escada Modular

Acabamento: Sendzimir - EN 10346

Acabamento: Galvanizado a Quente - EN EN 1461

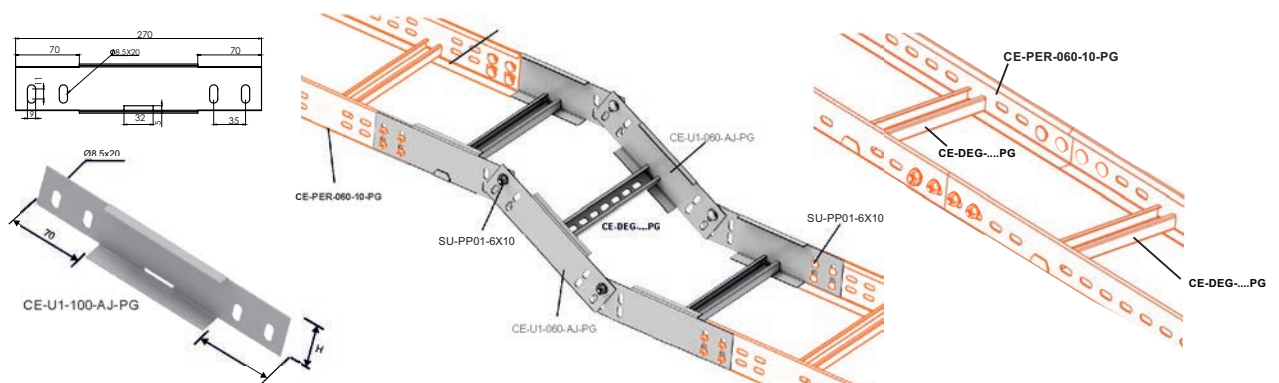

mm	mm	mm	kg	Código (Galvanizado Quente)	P.U. €		Código (Sendzimir)	P.U. €	
60mm	270mm	1,2mm	0,260kg	CE-U1-060-AJ-HDG	7,90€	●	CE-U1-060-AJ-PG	5,85€	●
100mm	270mm	1,2mm	0,345kg	CE-U1-100-AJ-HDG	11,10€	●	CE-U1-100-AJ-PG	8,25€	●

- Artigo de stock habitual
- Artigo disponível por encomenda

## União Lateral p/Caminho Cabos de Varão

Acabamento: Sendzimir - EN 10346

Acabamento: Galvanizado a Quente - EN EN 1461

Acabamento: Inox

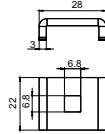
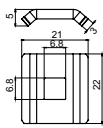
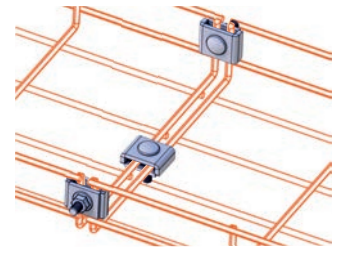

Código	mm	mm	mm	kg	Acabamento	P.U. €	
CV-U1	28mm	22mm	3,0mm	0,075kg	Sendzimir	1,13€	●
CV-U1-HDG	28mm	22mm	3,0mm	0,075kg	Galvanizado Quente	2,95€	●
CV-U1-SS304	28mm	22mm	3,0mm	0,075kg	Inox 304	5,30€	●

## União Ligeira p/Caminho Cabos de Varão



Código	mm	mm	mm	kg	Acabamento	P.U. €	
CV-U11	28mm	22mm	3,0mm	0,075kg	Sendzimir	0,70€	●

## Fixação para Suporte p/Caminho Cabos de Varão



Código	mm	mm	mm	kg	Acabamento	P.U. €	
CV-U12	28mm	22mm	3,0mm	0,075kg	Sendzimir	0,85€	●

## Anilha Alta p/Caminho Cabos de Varão



Código	mm	mm	mm	kg	Acabamento	P.U. €	
CV-U20	28mm	22mm	3,0mm	0,075kg	Sendzimir	0,45€	●

## Anilha Baixa p/Caminho Cabos de Varão



Código	mm	mm	mm	kg	Acabamento	P.U. €	
CV-U30	28mm	22mm	3,0mm	0,075kg	Sendzimir	0,40€	●

## União Rápida Lateral p/Caminho Cabos de Varão

Acabamento: Sendzimir - EN 10346

Acabamento: Galvanizado a Quente - EN EN 1461

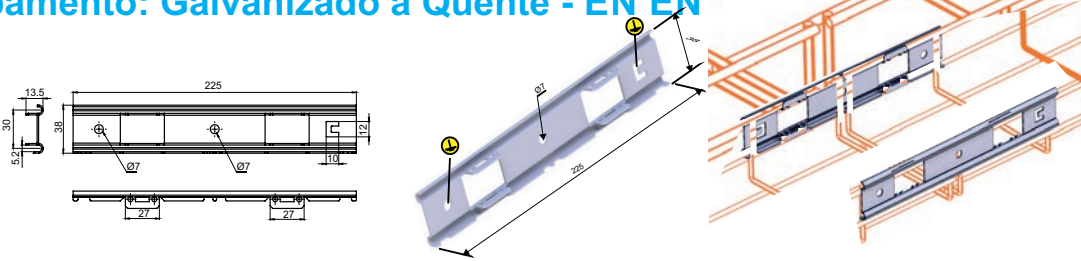

Código	mm	mm	mm	kg	Acabamento	P.U. €	
CV-U2-PG	225mm	30mm	0,90mm	0,075kg	Sendzimir	2,60€	●
CV-U2-HDG	225mm	30mm	0,90mm	0,075kg	Galvanizado Quente	7,00€	●

- Artigo de stock habitual
- Artigo disponível por encomenda

## Suspensão Lateral para Caminho Cabos de Varão

Acabamento: Sendzimir - EN 10346

Acabamento: Galvanizado a Quente - EN EN 1461

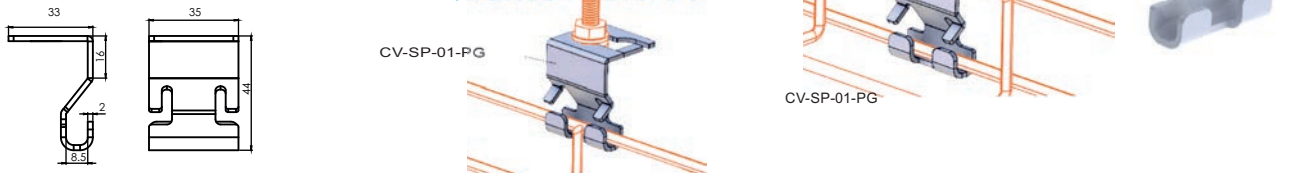

Código	mm	mm	mm	kg	Acabamento	P.U. €	
CV-SP-01-PG	35mm	44mm	2,0mm	0,045kg	Sendzimir	1,90€	●
CV-SP-01HDG	35mm	44mm	2,0mm	0,045kg	Galvanizado Quente	2,60€	●

- Artigo de stock habitual
- Artigo disponível por encomenda

## Suspensão Central para Caminho Cabos de Varão

Acabamento: Sendzimir - EN 10346

Acabamento: Galvanizado a Quente - EN EN 1461

Acabamento: Inox

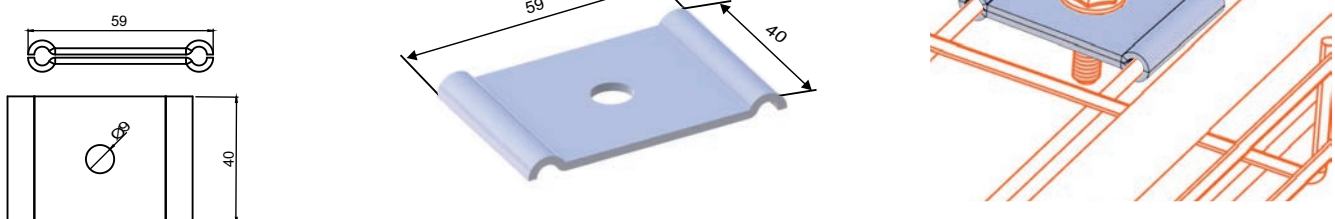

Código	mm	mm	mm	kg	Acabamento	P.U. €	
CV-SP-02-PG	59mm	40mm	2,0mm	0,040kg	Sendzimir	2,00€	●
CV-SP-02-HDG	59mm	40mm	2,0mm	0,040kg	Galvanizado Quente	2,70€	●
CV-SP-02-SS304	59mm	40mm	2,0mm	0,040kg	Inox 304	4,80€	●

- Artigo de stock habitual
- Artigo disponível por encomenda



## Suporte para Caixa Derivação para Caminho Cabos de Varão

Acabamento: Sendzimir - EN 10346

Acabamento: Galvanizado a Quente - EN 1461

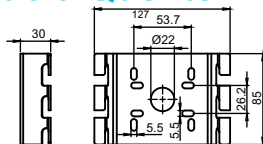

Código	mm	mm	mm	kg	Acabamento	P.U. €	
CV-SUP-CX-01-PG	127mm	85mm	2,0mm	0,019kg	Sendzimir	4,00€	●
CV-SUP-CX-01-HDG	127mm	85mm	2,0mm	0,019kg	Galvanizado Quente	7,10€	●
CV-SUP-CX-01-SS304	127mm	85mm	2,0mm	0,019kg	Inox 304	20,00€	●

● Artigo de stock habitual

● Artigo disponível por encomenda

## Suporte Longo para Caixa Derivação para Caminho Cabos de Varão

Acabamento: Sendzimir - EN 10346

Acabamento: Galvanizado a Quente - EN 1461

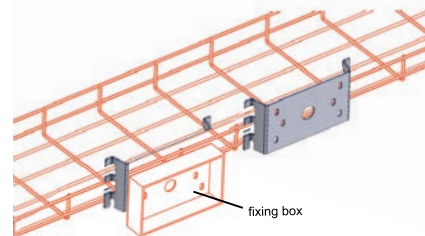
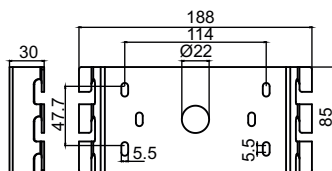

Código	mm	mm	mm	kg	Acabamento	P.U. €	
CV-SUP-CX-02-PG	188mm	85mm	2,0mm	0,027kg	Sendzimir	6,50€	●
CV-SUP-CX-02-HDG	188mm	85mm	2,0mm	0,027kg	Galvanizado Quente	10,60€	●
CV-SUP-CX-02-SS304	188mm	85mm	2,0mm	0,027kg	Inox 304	35,00€	●

● Artigo de stock habitual

● Artigo disponível por encomenda

## Borne Terra para Caminho Cabos



Código	Fixação	Cabo	Barra Conexão	Acabamento	P.U. €
CC-BORNE-TE-01	M6	10-35mm <sup>2</sup>	8mm <sup>2</sup>	Latão	4,80€

## Suporte em L para Caminho Cabos Chapa / Varão

Acabamento: Sendzimir - EN 10346

Acabamento: Galvanizado a Quente - EN 61537

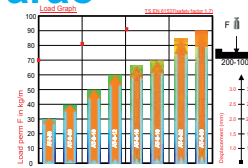

mm	mm	mm	kg	Código(Galvanizado Quente)	P.U. €	Código(Sendzimir)	P.U. €
100mm	75mm	1,5mm	0,145kg	SU-SUP-02-L100-HDG	7,50€	SU-SUP-02-L100-PG	5,55€
150mm	75mm	1,5mm	0,220kg	SU-SUP-02-L150-HDG	9,55€	SU-SUP-02-L150-PG	7,05€
200mm	75mm	1,5mm	0,420kg	SU-SUP-02-L200-HDG	10,55€	SU-SUP-02-L200-PG	7,80€
300mm	110mm	2,0mm	0,670kg	SU-SUP-02-L300-HDG	12,10€	SU-SUP-02-L300-PG	8,90€
400mm	110mm	2,0mm	0,800kg	SU-SUP-02-L400-HDG	13,95€	SU-SUP-02-L400-PG	10,30€
500mm	110mm	2,0mm	0,950kg	SU-SUP-02-L500-HDG	16,15€	SU-SUP-02-L500-PG	11,95€
600mm	110mm	2,0mm	0,950kg	SU-SUP-02-L600-HDG	20,25€	SU-SUP-02-L600-PG	15,00€

- Artigo de stock habitual
- Artigo disponível por encomenda

## Suporte em L para Caminho Cabos Chapa / Varão

Acabamento: Inox 304 - EN 10346

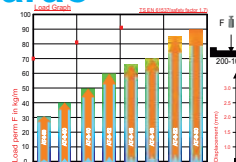

mm	mm	mm	kg	Código( Inox 304 )	P.U. €
100mm	75mm	1,5mm	0,145kg	SU-SUP-02-L100-SS304	18,50€
150mm	75mm	1,5mm	0,220kg	SU-SUP-02-L150-SS304	20,50€
200mm	75mm	1,5mm	0,420kg	SU-SUP-02-L200-SS304	23,30€
300mm	110mm	2,0mm	0,670kg	SU-SUP-02-L300-SS304	30,40€
400mm	110mm	2,0mm	0,800kg	SU-SUP-02-L400-SS304	35,00€
500mm	110mm	2,0mm	0,950kg	SU-SUP-02-L500-SS304	44,00€
600mm	110mm	2,0mm	0,950kg	SU-SUP-02-L600-SS304	49,30€

- Artigo de stock habitual
- Artigo disponível por encomenda

## Suporte em C para Caminho Cabos Chapa / Varão

Acabamento: Sendzimir - EN 10346

Acabamento: Galvanizado a Quente - EN 61537

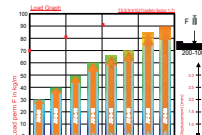

mm	mm	mm	kg	Código(Galvanizado Quente)	P.U. €	Código(Sendzimir)	P.U. €
100mm	75mm	1,5mm	0,145kg	SU-SUP-02-C100-HDG	10,15€	SU-SUP-02-C100-PG	7,50€
150mm	75mm	1,5mm	0,220kg	SU-SUP-02-C150-HDG	12,70€	SU-SUP-02-C150-PG	9,40€
200mm	75mm	1,5mm	0,420kg	SU-SUP-02-C200-HDG	13,40€	SU-SUP-02-C200-PG	9,90€
300mm	110mm	2,0mm	0,670kg	SU-SUP-02-C300-HDG	14,85€	SU-SUP-02-C300-PG	11,00€
400mm	110mm	2,0mm	0,800kg	SU-SUP-02-C400-HDG	18,40€	SU-SUP-02-C400-PG	13,60€
500mm	110mm	2,0mm	0,950kg	SU-SUP-02-C500-HDG	31,25€	SU-SUP-02-C500-PG	23,15€
600mm	110mm	2,0mm	0,950kg	SU-SUP-02-C600-HDG	34,15€	SU-SUP-02-C600-PG	25,30€

- Artigo de stock habitual
- Artigo disponível por encomenda

## Borne de Terra para Caminho Cabos de Varão

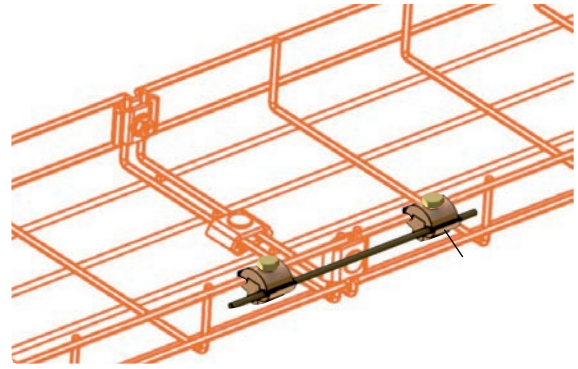
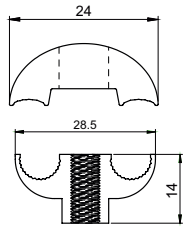

Código	mm	mm	mm	kg	Acabamento	P.U. €
CV-BORNE-TE-02	24mm	14mm	2,0mm	0,005kg	Latão	8,60€

## Suporte Reforçado Eletro galvanizado p/Cam.Cabos Chapa / Varão Acabamento: Galvanizado a Quente - EN 61537

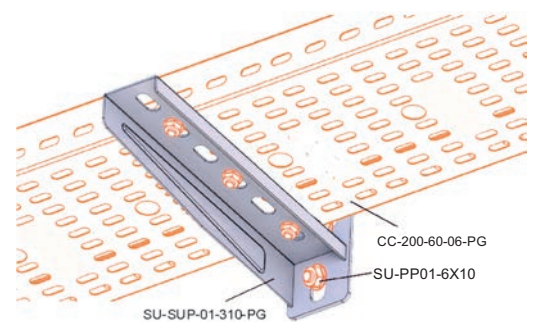
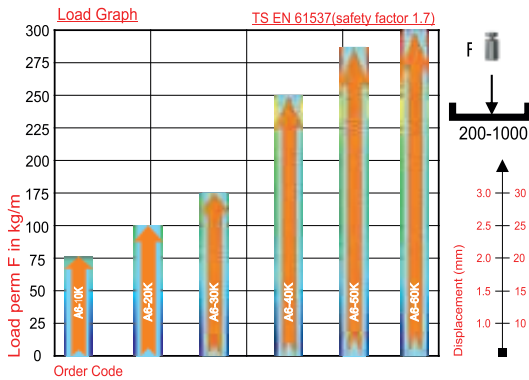
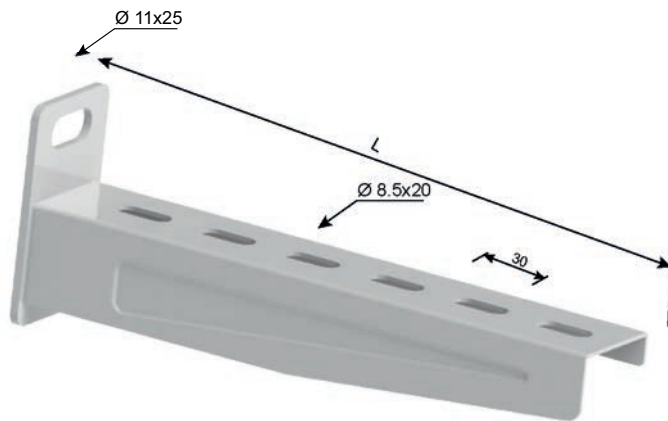
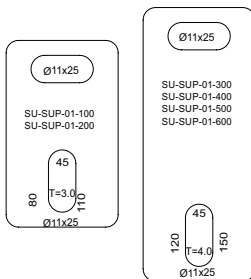

mm	mm	mm	kg	Código (Galvanizado Quente)	P.U. €	Código (Sendzimir)	P.U. €
110mm	75mm	1,5mm	0,145kg	SU-SUP-01-110-HDG	6,30€	SU-SUP-01-110-PG	4,65€
210mm	75mm	1,5mm	0,220kg	SU-SUP-01-210-HDG	7,40€	SU-SUP-01-210-PG	5,45€
310mm	75mm	1,5mm	0,420kg	SU-SUP-01-310-HDG	10,40€	SU-SUP-01-310-PG	7,70€
410mm	110mm	2,0mm	0,670kg	SU-SUP-01-410-HDG	12,10€	SU-SUP-01-410-PG	8,90€
510mm	110mm	2,0mm	0,800kg	SU-SUP-01-510-HDG	19,50	SU-SUP-01-510-PG	14,45€
610mm	110mm	2,0mm	0,950kg	SU-SUP-01-610-HDG	22,15€	SU-SUP-01-610-PG	16,40€

- Artigo de stock habitual
- Artigo disponível por encomenda

## Cable Trays Systems

### Distanciadores para Caminho Cabos Chapa / Varão

Acabamento: Sendzimir - EN 10346

Acabamento: Galvanizado a Quente - EN 61537

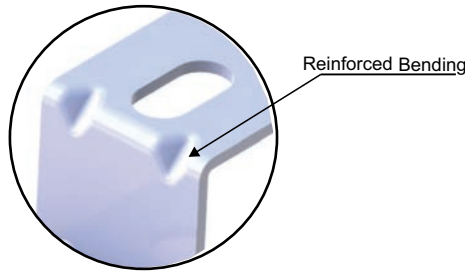

Reinforced Bending

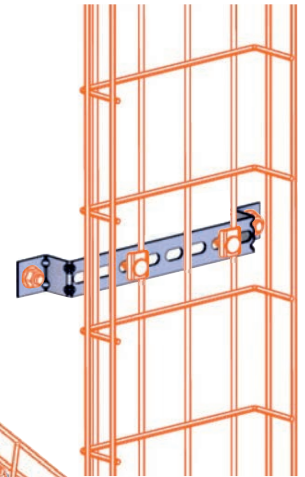
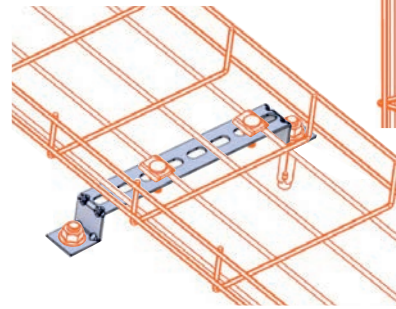
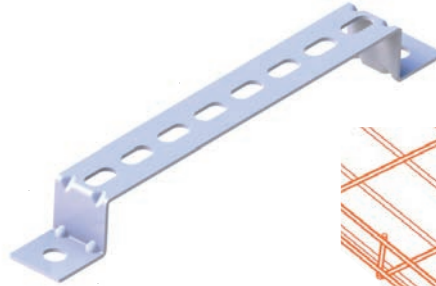
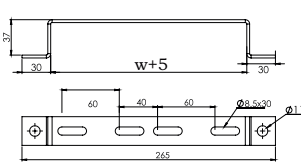

mm	mm	mm	kg	Código (Galvanizado Quente)	P.U. €	Código (Sendzimir)	P.U. €
100mm	40mm	2,5mm	0,150kg	SU-DIST-100-040-HDG	5,10€	SU-DIST-100-040-PG	3,75€
150mm	40mm	2,5mm	0,175kg	SU-DIST-150-040-HDG	5,67€	SU-DIST-150-040-PG	4,20€
200mm	40mm	2,5mm	0,200kg	SU-DIST-200-040-HDG	6,15€	SU-DIST-200-040-PG	4,55€
300mm	40mm	2,5mm	0,270kg	SU-DIST-300-040-HDG	6,90€	SU-DIST-300-040-PG	5,10€
400mm	40mm	3,0mm	0,385kg	SU-DIST-400-040-HDG	7,30€	SU-DIST-400-040-PG	5,40€
500mm	40mm	3,0mm	0,460kg	SU-DIST-500-040-HDG	8,10€	SU-DIST-500-040-PG	6,00€
600mm	40mm	3,0mm	0,525kg	SU-DIST-600-040-HDG	9,00€	SU-DIST-600-040-PG	6,65€

● Artigo de stock habitual

● Artigo disponível por encomenda

### Suspensão Central para Caminho Cabos Chapa / Escada

Acabamento: Sendzimir - EN 10346

Acabamento: Galvanizado a Quente - EN 61537

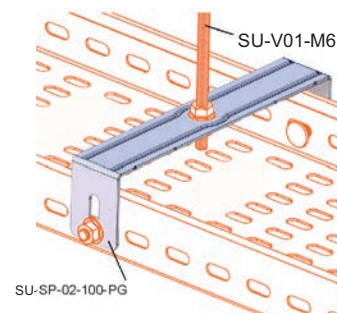
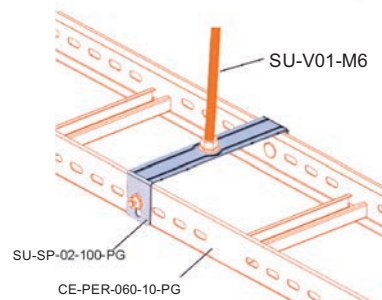
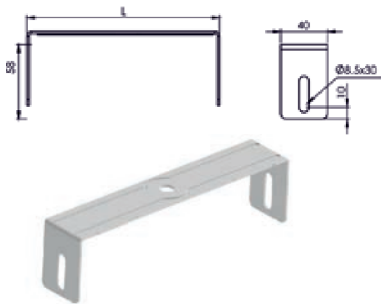

mm	mm	mm	kg	Código (Galvanizado Quente)	P.U. €	Código (Sendzimir)	P.U. €
50mm	58mm	1,2mm	0,070kg	SU-SP-02-050-HDG	6,75€	SU-SP-02-050-PG	5,00€
100mm	58mm	1,2mm	0,075kg	SU-SP-02-100-HDG	7,50€	SU-SP-02-100-PG	5,55€
150mm	58mm	1,2mm	0,105kg	SU-SP-02-150-HDG	8,00€	SU-SP-02-150-PG	6,00€
200mm	58mm	1,2mm	0,165kg	SU-SP-02-200-HDG	8,55€	SU-SP-02-200-PG	6,30€
300mm	58mm	1,2mm	0,195kg	SU-SP-02-300-HDG	9,65€	SU-SP-02-300-PG	7,50€

● Artigo de stock habitual

● Artigo disponível por encomenda

## Suporte Lateral para Caminho Cabos Chapa / Calha Escada

Acabamento: Sendzimir - EN 10346

Acabamento: Galvanizado a Quente - EN 61537

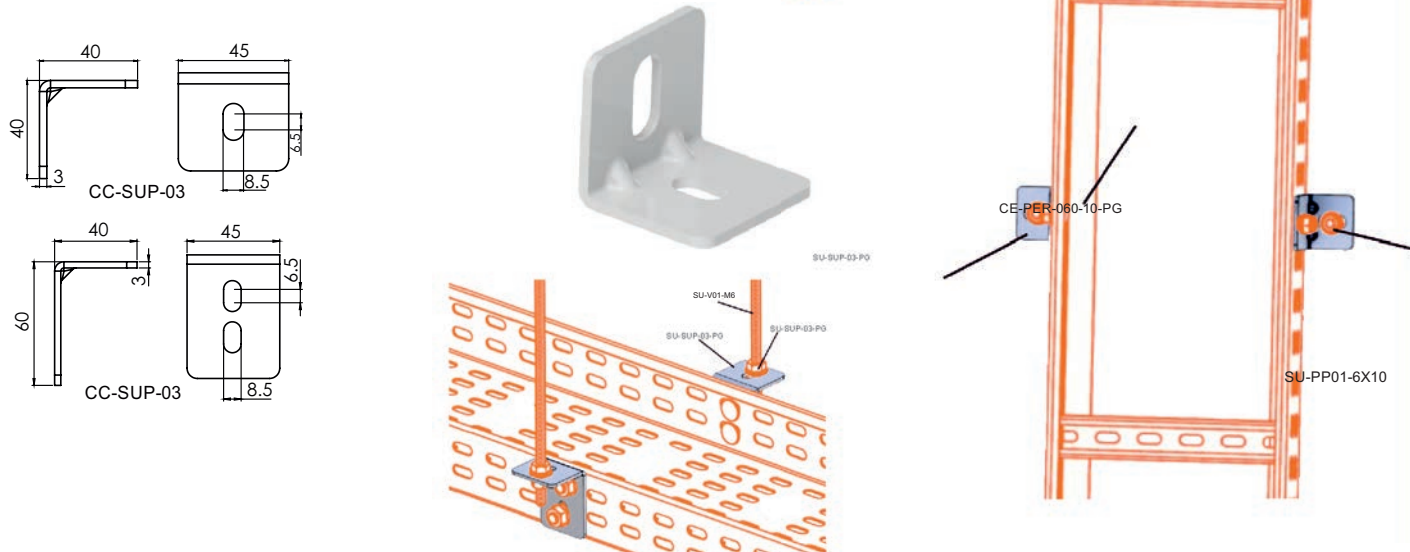

Código	mm	mm	kg/mt	mm	Acabamento	P.U. €
SU-SUP-03-PG	45mm	40mm	0,075g	3,0mm	Sendzimir	5,60€
SU-SUP-03-HDG	45mm	40mm	0,075g	3,0mm	Galvanizado Quente	7,55€

- Artigo de stock habitual
- Artigo disponível por encomenda

## Clip para Tampa p/Caminho Cabos

Acabamento: Sendzimir - EN 10346

Acabamento: Galvanizado a Quente - EN 61537



mm	mm	mm	kg	Código(Galvanizado Quente)	P.U. €	Código(Sendzimir)	P.U. €
20mm	40mm	2,0mm	0,028kg	CC-CLIP01-040-HDG	1,15€	CC-CLIP01-040-PG	0,85€
20mm	50mm	2,0mm	0,030kg	CC-CLIP01-050-HDG	1,30€	CC-CLIP01-050-PG	0,95€
20mm	60mm	2,0mm	0,032kg	CC-CLIP01-060-HDG	1,45€	CC-CLIP01-060-PG	1,05€
20mm	100mm	2,0mm	0,050kg	CC-CLIP01-100-HDG	1,65€	CC-CLIP01-100-PG	1,20€

- Artigo de stock habitual
- Artigo disponível por encomenda

## Perfil de Borracha para Proteção Calhas



Código	Descrição	P.U. €
CC-PER-BOR-01	Perfil de Borracha para protecção Calha Metálica ( Rolo com 100mts )	260,00€
CC-PER-BOR-02	Perfil de Borracha para protecção Calha Metálica ( Rolo com 5mts )	35,00€

- Artigo de stock habitual
- Artigo disponível por encomenda

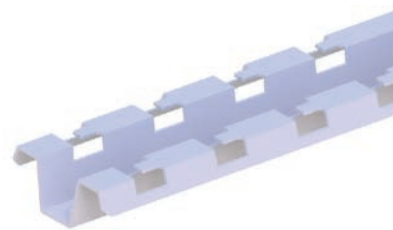

## Perfil Omega de Fixação Rápida

mm	mm	mm	mm	kg/mt	Código(Galvanizado Quente)	P.U./mt €		Código(Sendzimir)	P.U./mt €	
2000mm	75mm	1,5mm	2000mm	1,100kg/mt	SU-POFR-HDG	38,00€/mt	●	SU-POFR-PG	28,00€/mt	●

## Perfil em C

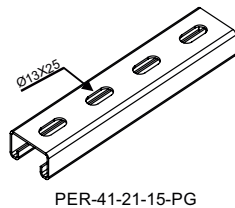
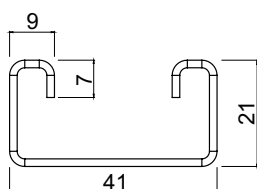

mm	mm	mm	mm	kg/mt	Código(Galvanizado Quente)	P.U./mt €		Código(Sendzimir)	P.U./mt €	
41mm	21mm	1,5mm	2000mm	1,100kg/mt	SU-P41-21-15-HDG	13,10€/mt	●	SU-P41-21-15-PG	9,65€/mt	●
41mm	21mm	2,0mm	2000mm	1,465kg/mt	SU-P41-21-20-HDG	16,15€/mt	●	SU-P41-21-20-PG	12,70€/mt	●

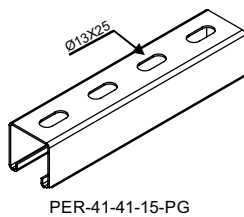
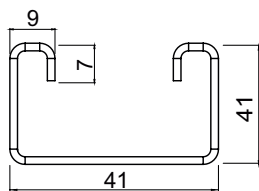

- Artigo de stock habitual
- Artigo disponível por encomenda

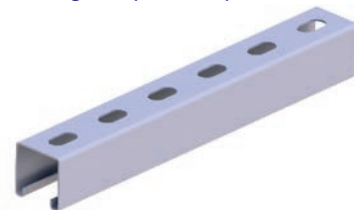

mm	mm	mm	mm	kg/mt	Código(Galvanizado Quente)	P.U./mt €		Código(Sendzimir)	P.U./mt €	
41mm	41mm	1,5mm	2000mm	1,420kg/mt	SU-P41-41-15-HDG	22,20€/mt	●	SU-P41-41-15-PG	16,45€/mt	●
41mm	41mm	2,0mm	2000mm	1,895kg/mt	SU-P41-41-20-HDG	24,85€/mt	●	SU-P41-41-20-PG	19,40€/mt	●

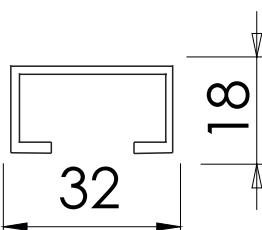

- Artigo de stock habitual
- Artigo disponível por encomenda



mm	mm	mm	mm	kg/mt	Código	Acabamento	P.U./mt €	
32mm	18mm	1,2mm	2000mm	1,420kg/mt	SU-P32-18-12-PG	Sendzimir	3,75€/mt	●
32mm	18mm	1,2mm	2000mm	1,695kg/mt	SU-P32-18-12-HDG	Galvanizado Quente	5,10€/mt	●
32mm	18mm	1,2mm	2000mm	1,895kg/mt	SU-P32-18-12-SS304	Inox 304	26,35€/mt	●

## Perfil em U

- Artigo de stock habitual
- Artigo disponível por encomenda

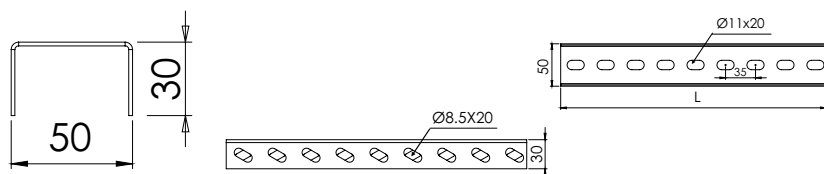

mm	mm	mm	mm	kg/mt	Código(Galvanizado Quente)	P.U./mt €		Código(Sendzimir)	P.U./mt €	
50mm	30mm	3000mm	1,5mm	1,090kg/mt	SU-P-U50-30-15-HDG	24,25€/mt	●	SU-P-U50-30-15-PG	17,95€/mt	●

- Artigo de stock habitual
- Artigo disponível por encomenda

# Suporte para Perfil C 41... Galvanizado a Quente

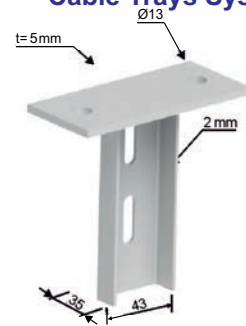
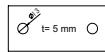
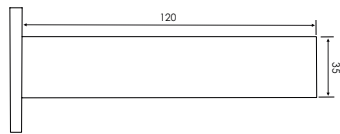

Código	mm	kg	mm	Acabamento	P.U. €
SU-BASE-PER-C-HDG	41mm	0,955kg	2,0mm	Galvanizado a Quente	7,50€

# Base para Perfil U

Taban Delik Detay  
Base hole detail

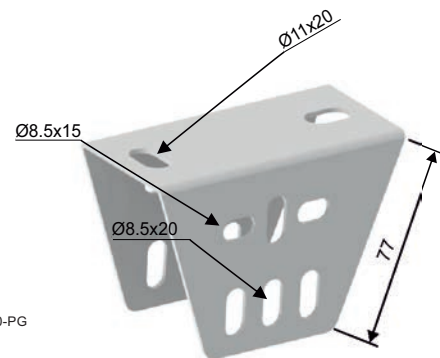
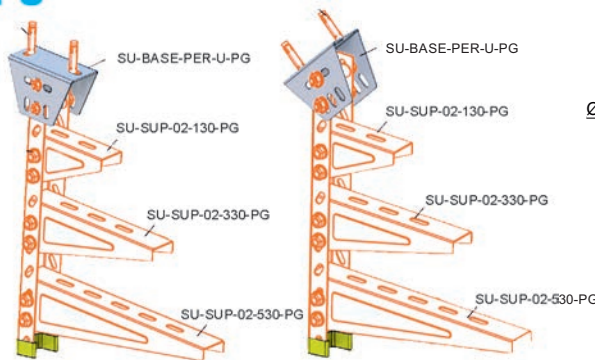
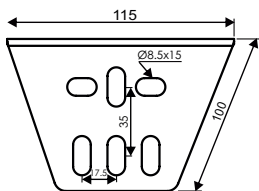
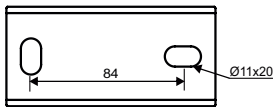

mm	mm	mm	kg	Código(Galvanizado Quente)	P.U. €	Código(Sendzimir)	P.U. €
115mm	100mm	2,0mm	0,270kg/mt	SU-BASE-PER-U-HDG	8,95€	SU-BASE-PER-U-PG	6,60€

- Artigo de stock habitual
- Artigo disponível por encomenda

# Suporte para Perfil U

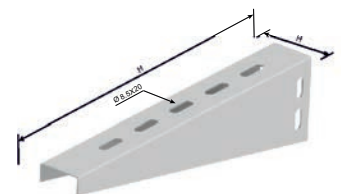
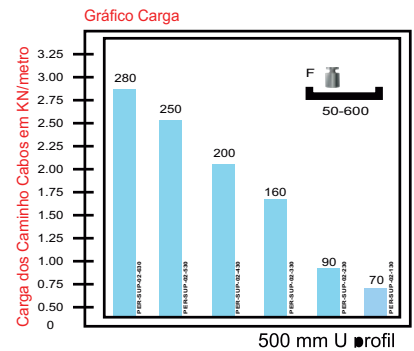
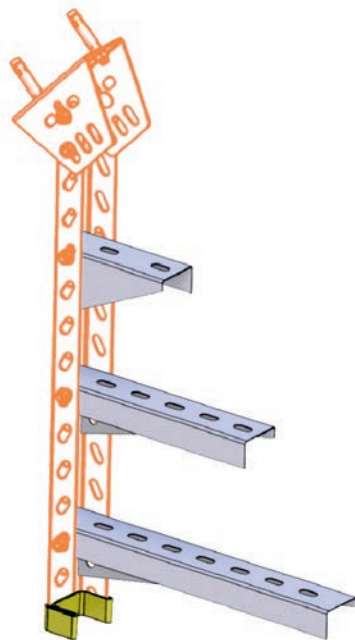
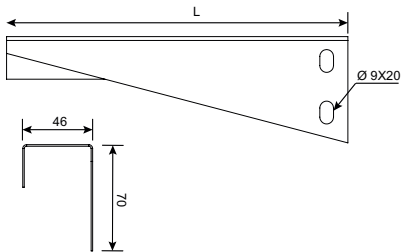
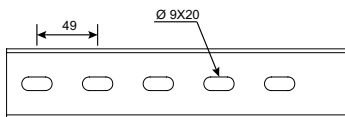

mm	mm	mm	mm	kg	Código(Galvanizado Quente)	P.U. €	Código(Sendzimir)	P.U. €
130mm	80mm	46mm	1,5mm	0,115kg	SU-SUP-02-130-HDG	7,80€	SU-SUP-02-130-PG	5,75€
230mm	80mm	46mm	1,5mm	0,205kg	SU-SUP-02-230-HDG	9,25€	SU-SUP-02-230-PG	6,85€
330mm	80mm	46mm	1,5mm	0,325kg	SU-SUP-02-330-HDG	13,10€	SU-SUP-02-330-PG	9,70€
430mm	80mm	46mm	2,0mm	0,460kg	SU-SUP-02-430-HDG	15,10€	SU-SUP-02-430-PG	11,15€
530mm	80mm	46mm	2,0mm	1,140kg	SU-SUP-02-530-HDG	20,55€	SU-SUP-02-530-PG	15,20€
630mm	80mm	46mm	2,0mm	1,335kg	SU-SUP-02-630-HDG	23,35€	SU-SUP-02-630-PG	17,30€

- Artigo de stock habitual
- Artigo disponível por encomenda

## Suporte para Perfil C 41X21 Galvanizado a Quente

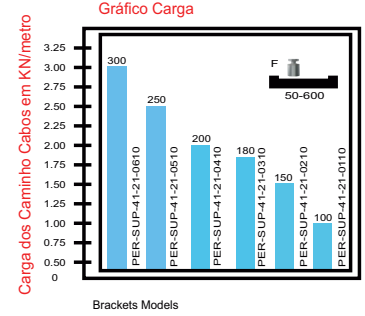
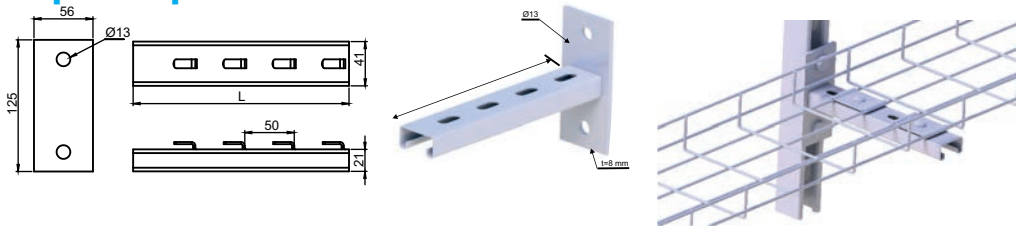

Código	mm	mm	mm	kg	mm	Acabamento	P.U. €
SU-SUP4121-0410HDG	410mm	121mm	45mm	0,955kg	2,0mm	Galvanizado a Quente	13,15€
SU-SUP4121-0610HDG	610mm	121mm	45mm	1,275kg	2,0mm	Galvanizado a Quente	15,65€

- Artigo de stock habitual
- Artigo disponível por encomenda

## Suporte para Perfil C 41X41 Galvanizado a Quente

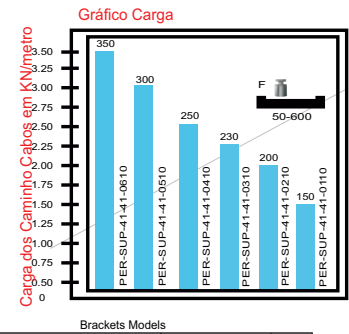
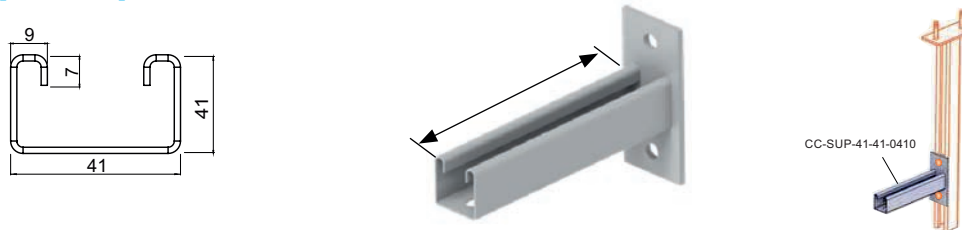

Código	mm	mm	mm	kg	mm	Acabamento	P.U. €
SU-SUP4141-0410HDG	410mm	121mm	45mm	1,240kg	2,0mm	Galvanizado a Quente	20,10€
SU-SUP4141-0610HDG	610mm	121mm	45mm	1,700kg	2,0mm	Galvanizado a Quente	25,65€
SU-SUP4141-1500HDG	1500mm	121mm	45mm	3,500kg	2,0mm	Galvanizado a Quente	48,40€

- Artigo de stock habitual
- Artigo disponível por encomenda

## União para Perfil C 41... Galvanizado a Quente

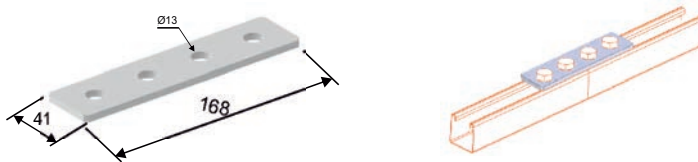

Código	mm	mm	mm	kg	mm	Acabamento	P.U. €
SU-UNI-P41-HDG	125mm	5mm	42mm	0,200kg	2,0mm	Galvanizado a Quente	5,80€

- Artigo de stock habitual
- Artigo disponível por encomenda

## Spray de Zinco



Código	Descrição	P.U. €
SU-SPRAY-ZINCO	Spray de Zinco Brilhante	15,00€

## Buchas de Latão



Código	Descrição	P.U. €/Cento
SU-BUCHA-LT6	Bucha Latão 6mm	16,60€/Cento
SU-BUCHA-LT8	Bucha Latão 8mm	47,00€/Cento
SU-BUCHA-LT10	Bucha Latão 10mm	84,50€/Cento
SU-BUCHA-LT10	Bucha Latão 10mm	189,00€/Cento





## Parafusos

Código	Descrição	Métrica	Comprimento	Acabamento	P.U. €	
SU-PP01-6X10-PG	Parafuso + Porca	M6	10mm	Galvanizado	21,05€/cento	●
SU-PP01-6X10-HDG	Parafuso + Porca	M6	10mm	Galvanizadao Quente	45,00€/cento	●
SU-PP01-6X15-SS304	Parafuso + Porca	M6	15mm	Inox304	40,00€/cento	●
SU-PP01-6X15-PG	Parafuso + Porca	M6	15mm	Galvanizado	26,00€/cento	●
SU-PP01-8X15-PG	Parafuso + Porca	M8	15mm	Galvanizado	28,50€/cento	●
SU-POR-SEX-M6	Porca M6	M6		Galvanizado	7,50€/cento	●
SU-POR-SEX-M8	Porca M8	M8		Galvanizado	8,50€/cento	●
SU-ANI-AL-M6	Anilha M6	M6		Galvanizado	12,00€/cento	●
SU-ANI-AL-M8	Anilha M8	M8		Galvanizado	13,00€/cento	●

- Artigo de stock habitual
- Artigo disponível por encomenda

## Varão Roscado



Descrição	Métrica	Acabamento	Código	mm	P.U. €		Código	mm	P.U. €	
Varão Roscado	M6	Galvanizado	SU-V01-M6	1000mm	1,85€	●	SU-V02-M6	2000mm	3,70€	●
Varão Roscado	M8	Galvanizado	SU-V01-M8	1000mm	2,75€	●	SU-V02-M8	2000mm	5,50€	●
Varão Roscado	M10	Galvanizado	SU-V01-M10	1000mm	3,15€	●	SU-V02-M10	2000mm	6,30€	●
Varão Roscado	M12	Galvanizado	SU-V01-M12	1000mm	4,20€	●	SU-V02-M12	2000mm	8,40€	●

## União para Varão Roscado



- Artigo de stock habitual
- Artigo disponível por encomenda

Código	Métrica	Descrição	Acabamento	P.U. €	
SU-UV01-M6	M6	Varão Roscado	Galvanizado	0,95€	●
SU-UV01-M8	M8	Varão Roscado	Galvanizado	1,35€	●
SU-UV01-M10	M10	Varão Roscado	Galvanizado	1,75€	●
SU-UV01-M12	M12	Varão Roscado	Galvanizado	2,25€	●

## Clip para Viga



Código	mm	Ø	Cor	P.U. €
SU-CLIP116	1-4mm	15-18mm	Preto	0,50€
SU-CLIP120	4-7,5mm	15-18mm	Preto	0,50€
SU-CLIP125	7,5-12mm	15-18mm	Preto	0,50€
SU-CLIP416	1-4mm	19-24mm	Preto	0,60€
SU-CLP420	4-7,5mm	19-24mm	Preto	0,60€
SU-CLIP425	7,5-12mm	19-24mm	Preto	0,60€
SU-CLIP716	1-4mm	25-30mm	Preto	0,70€
SU-CLIP720	4-7,5mm	25-30mm	Preto	0,70€
SU-CLIP725	7,5-12mm	25-30mm	Preto	0,70€

## Clip para Viga

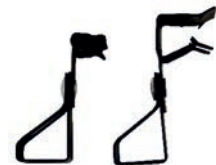

Código	mm	Furo	Cor	P.U. €
SU-CLIP04M6	1,5-4mm	M6	Preto	1,30€
SU-CLIP10M6	4-10mm	M6	Preto	1,30€
SU-CLIP15M6	10-15mm	M6	Preto	1,30€
SU-CLIP20M6	15-20mm	M6	Preto	1,30€
SU-CLIP04M8	1,5-4mm	M8	Preto	1,30€
SU-CLIP10M8	4-10mm	M8	Preto	1,30€
SU-CLIP15M8	10-15mm	M8	Preto	1,30€
SU-CLIP20M8	15-20mm	M8	Preto	1,30€

### Porca Guia

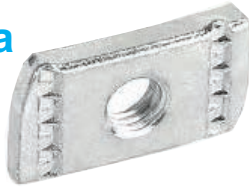

Código	Métrica	Perfil	P.U. €
SU-PG-M06	M6	P/Perfil 41x21	0,85€
SU-PG-M08	M8	P/Perfil 41x41	0,95€
SU-PG-M10	M10	P/Perfil 41x41	1,25€
SU-PG-M12	M12	P/Perfil 41x41	1,85€

### Mordaza para Varão Roscado

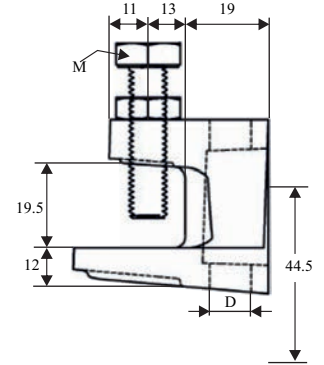
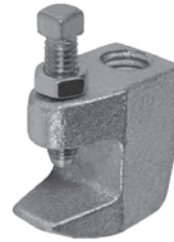

Código	Métrica	Espessura	P.U. €
SU-MO-M08	M8	0-22mm	4,65€
SU-MO-M10	M10	0-19mm	5,70€
SU-MO-M12	M12	5-25mm	6,10€

### Fixação do Perfil á Viga



Código	Descrição	P.U. €
SU-FIX-PERFIL-01	Abraçadeira Fixação Perfil	7,50€

### Fita D'Aço



Código	Rolo	Furo	Dimensões	P.U./€
SU-FAP12	10mts	5mm	12x0,8mm	8,55€/Rolo
SU-FAP17	10mts	7mm	17x0,8mm	10,70€/Rolo

### Topo para Perfil



Código	Descrição	Embal.	P.U. €
SU-TOPO-3218	Topo para Perfil 32x18	100unid.	0,90€
SU-TOPO-4121	Topo para Perfil 41x21	100unid.	1,28€
SU-TOPO-4141	Topo para Perfil 41x41	100unid.	1,28€

### Caixa de Chão

Código	Descrição	P.U. €
SL-CX-CC01	Caixa (Negativo) para Caixa Pavimento	41,85€
SL-ARO-CC01	Aro para Caixa Pavimento	31,50€
SL-TP-CC01	Tampa p/Proteção Cimento p/cx. Chão	16,15€

c) Tampa para proteção da caixa quando chumbada no piso (evita entrada de lixo)

b) Aro para Caixa Pavimento com Tampa

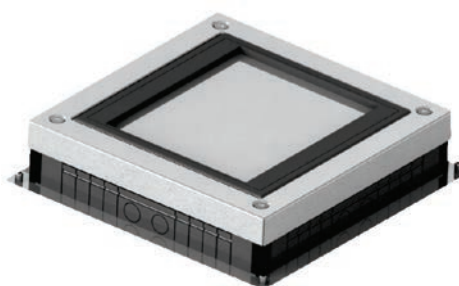

a) Caixa (Negativo) para Caixa Pavimento, apenas a Caixa

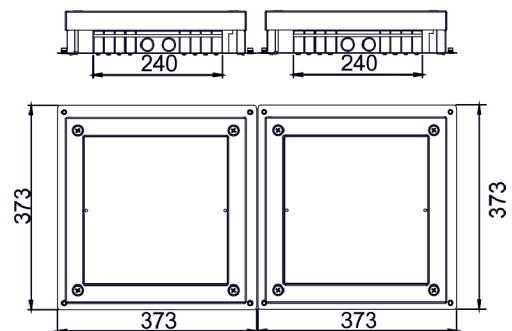
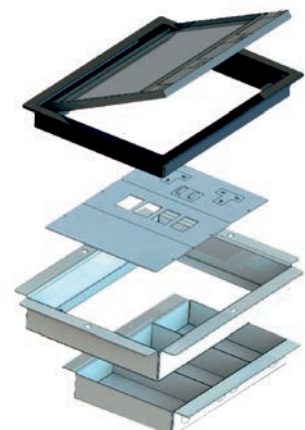

# Mini Sofia-Led

eco

Opção Casambi e Dali por Encomenda

soflight®



## CASAMBI



Plafonier em Resina com Difusor Opalino em PMMA  
Bulkhead Resin Material Opal Diffuser, PMMA  
220-240Vac, 6W Led 600lm, IP 65

Led: Lâmpada GX53

Led: Bulb GX53

VERSÃO LED / LED VERSION



(Incluída)

### Mini Sofia-RS Led ( Eco )



**002.040WOGX53.6.84**

LED - 4000K  
190x71mm  
Branco / White  
Emb./Box Qt. 20pcs  
P.U. 18,00€



**002.040GOGX53.6.84**

LED - 4000K  
190x71mm  
Cinza / Grey  
Emb./Box Qt. 20pcs  
P.U. 18,00€



**002.040BOGX53.6.84**

LED - 4000K  
190x71mm  
Preto / Black  
Emb./Box Qt. 20pcs  
P.U. 18,00€



**002.040AOGX53.6.84**

LED - 4000K  
190x71mm  
Antracite / Dark Grey  
Emb./Box Qt. 20pcs  
P.U. 19,10€

### Mini Sofia-OS Led ( Eco )



**002.050WOGX53.6.84**

LED - 4000K  
240x170x71mm  
Branco / White  
Emb./Box Qt. 20pcs  
P.U. 18,00€



**002.050GOGX53.6.84**

LED - 4000K  
240x170x71mm  
Cinza / Grey  
Emb./Box Qt. 20pcs  
P.U. 18,00€



**002.050BOGX53.6.84**

LED - 4000K  
240x170x71mm  
Preto / Black  
Emb./Box Qt. 20pcs  
P.U. 18,00€



**002.050AOGX53.6.84**

LED - 4000K  
240x170x71mm  
Antracite / Dark Grey  
Emb./Box Qt. 20pcs  
P.U. 19,10€

### Mini Sofia-QS Led ( Eco )



**002.060WOGX53.6.84**

LED - 4000K  
185x185x62mm  
Branco / White  
Emb./Box Qt. 20pcs  
P.U. 20,80€



**002.060GOGX53.6.84**

LED - 4000K  
185x185x62mm  
Cinza / Grey  
Emb./Box Qt. 20pcs  
P.U. 20,80€



**002.060BOGX53.6.84**

LED - 4000K  
185x185x62mm  
Preto / Black  
Emb./Box Qt. 20pcs  
P.U. 20,80€



**002.060AOGX53.6.84**

LED - 4000K  
185x185x62mm  
Antracite / Dark Grey  
Emb./Box Qt. 20pcs  
P.U. 22,50€



Opção Casambi e Dali por Encomenda

CASAMBI



VERSÃO LED / LED VERSION

Plafonier em Resina com Difusor Opalino em PMMA  
Bulkhead Resin Material Opal Diffuser, PMMA  
220-240Vac, 7W Led 900lm, IP 65

Led: **OSRAM**

Placa Led 50 000 Horas; 2 Anos Garantia  
Led PCB 50 000 Hours; 2 Years Warranty



(Incluida)

Mini Sofia-RS Led



002.040WO.L15.82

LED - 2700K  
190x71mm  
Branco / White  
Emb./Box Qt. 20pcs  
P.U. 39,90€

002.040WO.L15.84

LED - 4000K  
190x71mm  
Branco / White  
Emb./Box Qt. 20pcs  
P.U. 39,90€



002.040GO.L15.82

LED - 2700K  
190x71mm  
Cinza / Grey  
Emb./Box Qt. 20pcs  
P.U. 39,90€

002.040GO.L15.84

LED - 4000K  
190x71mm  
Cinza / Grey  
Emb./Box Qt. 20pcs  
P.U. 39,90€



002.040BO.L15.82

LED - 2700K  
190x71mm  
Preto / Black  
Emb./Box Qt. 20pcs  
P.U. 39,90€

002.040BO.L15.84

LED - 4000K  
190x71mm  
Preto / Black  
Emb./Box Qt. 20pcs  
P.U. 39,90€



002.040AO.L15.82

LED - 2700K  
190x71mm  
Antacite / Dark Grey  
Emb./Box Qt. 20pcs  
P.U. 41,25€

002.040AO.L15.84

LED - 4000K  
190x71mm  
Antracite / Dark Grey  
Emb./Box Qt. 20pcs  
P.U. 41,25€

Mini Sofia-OS Led



002.050WO.L15.82

LED - 2700K  
240x170x71mm  
Branco / White  
Emb./Box Qt. 20pcs  
P.U. 39,90€

002.050WO.L15.84

LED - 4000K  
240x170x71mm  
Branco / White  
Emb./Box Qt. 20pcs  
P.U. 39,90€



002.050GO.L15.82

LED - 2700K  
240x170x71mm  
Cinza / Grey  
Emb./Box Qt. 20pcs  
P.U. 39,90€

002.050GO.L15.84

LED - 4000K  
240x170x71mm  
Cinza / Grey  
Emb./Box Qt. 20pcs  
P.U. 39,90€



002.050BO.L15.82

LED - 2700K  
240x170x71mm  
Preto / Black  
Emb./Box Qt. 20pcs  
P.U. 39,90€

002.050BO.L15.84

LED - 4000K  
240x170x71mm  
Preto / Black  
Emb./Box Qt. 20pcs  
P.U. 39,90€



002.050AO.L15.82

LED - 2700K  
240x170x71mm  
Antacite / Dark Grey  
Emb./Box Qt. 20pcs  
P.U. 41,25€

002.050AO.L15.84

LED - 4000K  
240x170x71mm  
Antracite / Dark Grey  
Emb./Box Qt. 20pcs  
P.U. 41,25€

Mini Sofia-QS Led



002.060WO.L15.82

LED - 2700K  
185x185x62mm  
Branco / White  
Emb./Box Qt. 20pcs  
P.U. 42,60€

002.060WO.L15.84

LED - 4000K  
185x185x62mm  
Branco / White  
Emb./Box Qt. 20pcs  
P.U. 42,60€



002.060GO.L15.82

LED - 2700K  
185x185x62mm  
Cinza / Grey  
Emb./Box Qt. 20pcs  
P.U. 42,60€

002.060GO.L15.84

LED - 4000K  
185x185x62mm  
Cinza / Grey  
Emb./Box Qt. 20pcs  
P.U. 42,60€



002.060BO.L15.82

LED - 2700K  
185x185x62mm  
Preto / Black  
Emb./Box Qt. 20pcs  
P.U. 42,60€

002.060BO.L15.84

LED - 4000K  
185x185x62mm  
Preto / Black  
Emb./Box Qt. 20pcs  
P.U. 42,60€



002.060AO.L15.82

LED - 2700K  
185x185x62mm  
Antacite / Dark Grey  
Emb./Box Qt. 20pcs  
P.U. 44,00€

002.060AO.L15.84

LED - 4000K  
185x185x62mm  
Antracite / Dark Grey  
Emb./Box Qt. 20pcs  
P.U. 44,00€

## CASAMBI



Plafonier em Resina com Difusor Opalino em PMMA  
Bulkhead Resin Material Opal Diffuser, PMMA  
220-240-Vac, 16W Led 1900lm, IP 65

**Led: OSRAM**

Placa Led 50 000 Horas; 2 Anos Garantia  
Led PCB 50 000 Hours; 2 Years Warranty

VERSÃO LED / LED VERSION



(Incluida)

### Sofia-RS Led



**002.010WO.L15.82**

LED - 2700K  
295x96mm  
Branco / White  
Emb./Box Qt. 14pcs  
P.U. 43,00€



**002.010GO.L15.82**

LED - 2700K  
295x96mm  
Cinza / Grey  
Emb./Box Qt. 14pcs  
P.U. 43,00€



**002.010BO.L15.82**

LED - 2700K  
295x96mm  
Preto / Black  
Emb./Box Qt. 14pcs  
P.U. 43,00€



**002.010AO.L15.82**

LED - 2700K  
295x96mm  
Antacite / Dark Grey  
Emb./Box Qt. 14pcs  
P.U. 44,00€

**002.010WO.L15.84**

LED - 4000K  
295x96mm  
Branco / White  
Emb./Box Qt. 14pcs  
P.U. 43,00€

**002.010GO.L15.84**

LED - 4000K  
295x96mm  
Cinza / Grey  
Emb./Box Qt. 14pcs  
P.U. 43,00€

**002.010BO.L15.84**

LED - 4000K  
295x96mm  
Preto / Black  
Emb./Box Qt. 14pcs  
P.U. 43,00€

**002.010AO.L15.84**

LED - 4000K  
295x96mm  
Antracite / Dark Grey  
Emb./Box Qt. 14pcs  
P.U. 44,00€

### Sofia-RC Led



**002.011WO.L15.82**

LED - 2700K  
295x96mm  
Branco / White  
Emb./Box Qt. 14pcs  
P.U. 43,00€



**002.011GO.L15.82**

LED - 2700K  
295x96mm  
Cinza / Grey  
Emb./Box Qt. 14pcs  
P.U. 43,00€



**002.011BO.L15.82**

LED - 2700K  
295x96mm  
Preto / Black  
Emb./Box Qt. 14pcs  
P.U. 43,00€



**002.011AO.L15.82**

LED - 2700K  
295x96mm  
Antacite / Dark Grey  
Emb./Box Qt. 14pcs  
P.U. 44,00€

**002.011WO.L15.84**

LED - 4000K  
295x96mm  
Branco / White  
Emb./Box Qt. 14pcs  
P.U. 43,00€

**002.011GO.L15.84**

LED - 4000K  
295x96mm  
Cinza / Grey  
Emb./Box Qt. 14pcs  
P.U. 43,00€

**002.011BO.L15.84**

LED - 4000K  
295x96mm  
Preto / Black  
Emb./Box Qt. 14pcs  
P.U. 43,00€

**002.011AO.L15.84**

LED - 4000K  
295x96mm  
Antracite / Dark Grey  
Emb./Box Qt. 14pcs  
P.U. 44,00€



### Tampa 35° para PlafonierSOFIA Redondo Back cover for Bulkhead SOFIA Round

003.050W035.R Tampa / Back Cover SOFIA-RS/RC (BR/WH)

P.U. 8,50€

003.050B035.R Tampa / Back Cover SOFIA-RS/RC (PT/BK)

P.U. 8,50€

003.050G035.R Tampa / Back Cover SOFIA-RS/RC (CZ/GR)

P.U. 8,50€

003.050A035.R Tampa / Back Cover SOFIA-RS/RC (AN/DG)

P.U. 9,00€

Opção Casambi e Dali por Encomenda

## CASAMBI



Plafonier em Resina com Difusor Opalino em PMMA  
Bulkhead Resin Material Opal Diffuser, PMMA  
220-240Vac, 16W Led 1900lm, IP 65

Led: **OSRAM**

Placa Led 50 000 Horas; 2 Anos Garantia  
Led PCB 50 000 Hours; 2 Years Warranty

VERSÃO LED / LED VERSION



(Incluida)

### Sofia-OS Led



**002.020WO.L15.82**

LED - 2700K  
320x230x96mm  
Branco / White  
Emb./Box Qt. 14pcs  
P.U. 43,00€



**002.020GO.L15.82**

LED - 2700K  
320x230x96mm  
Cinza / Grey  
Emb./Box Qt. 14pcs  
P.U. 43,00€



**002.020BO.L15.82**

LED - 2700K  
320x230x96mm  
Preto / Black  
Emb./Box Qt. 14pcs  
P.U. 43,00€



**002.020AO.L15.82**

LED - 2700K  
320x230x96mm  
Antacite / Dark Grey  
Emb./Box Qt. 14pcs  
P.U. 44,00€

**002.020WO.L15.84**

LED - 4000K  
320x230x96mm  
Branco / White  
Emb./Box Qt. 14pcs  
P.U. 43,00€

**002.020GO.L15.84**

LED - 4000K  
320x230x96mm  
Cinza / Grey  
Emb./Box Qt. 14pcs  
P.U. 43,00€

**002.020BO.L15.84**

LED - 4000K  
320x230x96mm  
Preto / Black  
Emb./Box Qt. 14pcs  
P.U. 43,00€

**002.020AO.L15.84**

LED - 4000K  
320x230x96mm  
Antracite / Dark Grey  
Emb./Box Qt. 14pcs  
P.U. 44,00€

### Sofia-OC Led



**002.021WO.L15.82**

LED - 2700K  
320x230x96mm  
Branco / White  
Emb./Box Qt. 14pcs  
P.U. 43,00€



**002.021GO.L15.82**

LED - 2700K  
320x230x96mm  
Cinza / Grey  
Emb./Box Qt. 14pcs  
P.U. 43,00€



**002.021BO.L15.82**

LED - 2700K  
320x230x96mm  
Preto / Black  
Emb./Box Qt. 14pcs  
P.U. 43,00€



**002.021AO.L15.82**

LED - 2700K  
320x230x96mm  
Antacite / Dark Grey  
Emb./Box Qt. 14pcs  
P.U. 44,00€

**002.021WO.L15.84**

LED - 4000K  
320x230x96mm  
Branco / White  
Emb./Box Qt. 14pcs  
P.U. 43,00€

**002.021GO.L15.84**

LED - 4000K  
320x230x96mm  
Cinza / Grey  
Emb./Box Qt. 14pcs  
P.U. 43,00€

**002.021BO.L15.84**

LED - 4000K  
320x230x96mm  
Preto / Black  
Emb./Box Qt. 14pcs  
P.U. 43,00€

**002.021AO.L15.84**

LED - 4000K  
320x230x96mm  
Antracite / Dark Grey  
Emb./Box Qt. 14pcs  
P.U. 44,00€



### Tampa 35° para Plafonier SOFIA Oval Back cover for Bulkhead SOFIA Oval

003.050W035.O Tampa / Back Cover SOFIA-OS/OC (BR/WH)

P.U. 8,50€

003.050B035.O Tampa / Back Cover SOFIA-OS/OC (PT/BK)

P.U. 8,50€

003.050G035.O Tampa / Back Cover SOFIA-OS/OC (CZ/GR)

P.U. 8,50€

003.050A035.O Tampa / Back Cover SOFIA-OS/OC (AN/DG)

P.U. 9,00€

Opção Casambi e Dali por Encomenda

## CASAMBI



Plafonier em Resina com Difusor Opalino em PMMA  
Bulkhead Resin Material Opal Diffuser, PMMA  
220-240Vac, 16W Led 1900lm, IP 65

Led: **OSRAM**

Placa Led 50 000 Horas; 2 Anos Garantia  
Led PCB 50 000 Hours; 2 Years Warranty

VERSÃO LED / LED VERSION



(Incluida)

## Sofia-QS Led



**002.030WO.L15.82**

LED - 2700K  
295x295x85mm  
Branco / White  
Emb./Box Qt. 14pcs  
P.U. 44,00€



**002.030GO.L15.82**

LED - 2700K  
295x295x85mm  
Cinza / Grey  
Emb./Box Qt. 14pcs  
P.U. 44,00€



**002.030BO.L15.82**

LED - 2700K  
295x295x85mm  
Preto / Black  
Emb./Box Qt. 14pcs  
P.U. 44,00€



**002.030AO.L15.82**

LED - 2700K  
295x295x85mm  
Antacite / Dark Grey  
Emb./Box Qt. 14pcs  
P.U. 45,00€

**002.030WO.L15.84**

LED - 4000K  
295x295x85mm  
Branco / White  
Emb./Box Qt. 14pcs  
P.U. 44,00€

**002.030GO.L15.84**

LED - 4000K  
295x295x85mm  
Cinza / Grey  
Emb./Box Qt. 14pcs  
P.U. 44,00€

**002.030BO.L15.84**

LED - 4000K  
295x295x85mm  
Preto / Black  
Emb./Box Qt. 14pcs  
P.U. 44,00€

**002.030AO.L15.84**

LED - 4000K  
295x295x85mm  
Antracite / Dark Grey  
Emb./Box Qt. 14pcs  
P.U. 45,00€

## Sofia-QC Led



**002.031WO.L15.82**

LED - 2700K  
295x295x85mm  
Branco / White  
Emb./Box Qt. 14pcs  
P.U. 44,00€



**002.031GO.L15.82**

LED - 2700K  
295x295x85mm  
Cinza / Grey  
Emb./Box Qt. 14pcs  
P.U. 44,00€



**002.031BO.L15.82**

LED - 2700K  
295x295x85mm  
Preto / Black  
Emb./Box Qt. 14pcs  
P.U. 44,00€



**002.031AO.L15.82**

LED - 2700K  
295x295x85mm  
Antacite / Dark Grey  
Emb./Box Qt. 14pcs  
P.U. 45,00€

**002.031WO.L15.84**

LED - 4000K  
295x295x85mm  
Branco / White  
Emb./Box Qt. 14pcs  
P.U. 44,00€

**002.031GO.L15.84**

LED - 4000K  
295x295x85mm  
Cinza / Grey  
Emb./Box Qt. 14pcs  
P.U. 44,00€

**002.031BO.L15.84**

LED - 4000K  
295x295x85mm  
Preto / Black  
Emb./Box Qt. 14cs  
P.U. 44,00€

**002.031AO.L15.84**

LED - 4000K  
295x295x85mm  
Antracite / Dark Grey  
Emb./Box Qt. 14pcs  
P.U. 45,00€



### Tampa 35° para Plafonier SOFIA Quadrado Back cover for Bulkhead SOFIA Square

003.050W035.Q Tampa / Back Cover SOFIA-QS/QC (BR/WH)	P.U. 8,50€
003.050B035.Q Tampa / Back Cover SOFIA-QS/QC (PT/BK)	P.U. 8,50€
003.050G035.Q Tampa / Back Cover SOFIA-QS/QC (CZ/GR)	P.U. 8,50€
003.050A035.Q Tampa / Back Cover SOFIA-QS/QC (AN/DG)	P.U. 9,00€



Plafonier em Resina com Difusor Opalino em PMMA  
Bulkhead Resin Material Opal Diffuser, PMMA  
220-240Vac, Max. 26W - E27 IP 65

VERSÃO E27 / E27 VERSION



(Não Incluída)

## Sofia-RS E27



**002.010WO.E27**

E27 - Max. 26W  
295x96mm  
Branco / White  
Emb./Box Qt. 14pcs  
P.U. 18,50€



**002.010GO.E27**

E27 - Max. 26W  
295x96mm  
Cinza / Grey  
Emb./Box Qt. 14pcs  
P.U. 18,50€



**002.010BO.E27**

E27 - Max- 26W  
295x96mm  
Preto / Black  
Emb./Box Qt. 14pcs  
P.U. 18,50€



**002.010AO.E27**

E27 - Max. 26W  
295x96mm  
Antacite / Dark Grey  
Emb./Box Qt. 14pcs  
P.U. 19,00€

## Sofia-RC E27



**002.011WO.E27**

E27 - Max. 26W  
295x96mm  
Branco / White  
Emb./Box Qt. 14pcs  
P.U. 18,50€



**002.011GO.E27**

E27 - Max. 26W  
295x96mm  
Cinza / Grey  
Emb./Box Qt. 14pcs  
P.U. 18,50€



**002.011BO.E27**

E27 - Max- 26W  
295x96mm  
Preto / Black  
Emb./Box Qt. 14pcs  
P.U. 18,50€



**002.011AO.E27**

E27 - Max. 26W  
295x96mm  
Antacite / Dark Grey  
Emb./Box Qt. 14pcs  
P.U. 19,00€

## Sofia-OS E27



**002.020WO.E27**

E27 - Max. 26W  
320x230x96mm  
Branco / White  
Emb./Box Qt. 14pcs  
P.U. 18,50€



**002.020GO.E27**

E27 - Max. 26W  
320x230x96mm  
Cinza / Grey  
Emb./Box Qt. 14pcs  
P.U. 18,50€



**002.020BO.E27**

E27 - Max- 26W  
320x230x96mm  
Preto / Black  
Emb./Box Qt. 14pcs  
P.U. 18,50€



**002.020AO.E27**

E27 - Max. 26W  
320x230x96mm  
Antacite / Dark Grey  
Emb./Box Qt. 14pcs  
P.U. 19,00€

## Sofia-OC E27



**002.021WO.E27**

E27 - Max. 26W  
320x230x96mm  
Branco / White  
Emb./Box Qt. 14pcs  
P.U. 18,50€



**002.021GO.E27**

E27 - Max. 26W  
320x230x96mm  
Cinza / Grey  
Emb./Box Qt. 14pcs  
P.U. 18,50€



**002.021BO.E27**

E27 - Max- 26W  
320x230x96mm  
Preto / Black  
Emb./Box Qt. 14pcs  
P.U. 18,50€

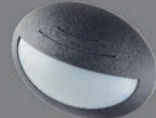

**002.021AO.E27**

E27 - Max. 26W  
320x230x96mm  
Antacite / Dark Grey  
Emb./Box Qt. 14pcs  
P.U. 19,00€



# Sofia QS/QC-E27

soflight®



Plafonier em Resina com Difusor Opalino em PMMA  
Bulkhead Resin Material Opal Diffuser, PMMA  
220-240Vac, Max. 2x15W - E27, IP 65

VERSÃO E27 / E27 VERSION



(Não Incluída)

## Sofia-QS E27



**002.030WO.2E27**

E27 - Max. 2x15W  
295x295x85mm  
Branco / White  
Emb./Box Qt. 14pcs  
P.U. 24,30€



**002.030GO.2E27**

E27 - Max. 2x15W  
295x295x85mm  
Cinza / Grey  
Emb./Box Qt. 14pcs  
P.U. 24,30€



**002.030BO.2E27**

E27 - Max. 2x15W  
295x295x85mm  
Preto / Black  
Emb./Box Qt. 14pcs  
P.U. 24,30€



**002.030AO.2E27**

E27 - Max. 2x15W  
295x295x85mm  
Antracite / Dark Grey  
Emb./Box Qt. 14pcs  
P.U. 25,50€

## Sofia-QC E27



**002.031WO.2E27**

E27 - Max. 2x15W  
295x295x85mm  
Branco / White  
Emb./Box Qt. 14pcs  
P.U. 24,30€



**002.031GO.2E27**

E27 - Max. 2x15W  
295x295x85mm  
Cinza / Grey  
Emb./Box Qt. 14pcs  
P.U. 24,30€



**002.031BO.2E27**

E27 - Max. 2x15W  
295x295x85mm  
Preto / Black  
Emb./Box Qt. 14pcs  
P.U. 24,30€



**002.031AO.2E27**

E27 - Max. 2x15W  
295x295x85mm  
Antracite / Dark Grey  
Emb./Box Qt. 14pcs  
P.U. 25,50€

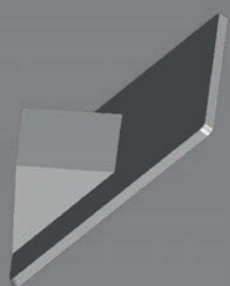

## Tampa 35° para Plafonier SOFIA Quadrado Back cover for Bulkhead SOFIA Square

003.050W035.Q Tampa / Back Cover SOFIA-QS/QC (BR/WH)

P.U. 8,50€

003.050B035.Q Tampa / Back Cover SOFIA-QS/QC (PT/BK)

P.U. 8,50€

003.050G035.Q Tampa / Back Cover SOFIA-QS/QC (CZ/GR)

P.U. 8,50€

003.050A035.Q Tampa / Back Cover SOFIA-QS/QC (AN/DG)

P.U. 9,00€



# Projetores Espeto PORTO

Projektor Espeto GU10 Led IP 65  
Led Spike GU10 Led IP 65  
Máximo 6W Led

## Porto

VERSÃO LED / LED VERSION

### Porto



(Incluída Lâmpada 2700K)



Fornecido sem Lâmpada

**007.010.WC.010**

Branco / White  
Emb./Box Qt. 15pcs  
P.U. 37,00€

**007.010.GC.010**

Cinza / Grey  
Emb./Box Qt. 15pcs  
P.U. 37,00€

**007.010.BC.010**

Preto / Black  
Emb./Box Qt. 15pcs  
P.U. 37,00€

**007.010.AC.010**

Antracite / Dark Grey  
Emb./Box Qt. 15pcs  
P.U. 38,00€

Oferta Lâmpada na cor 2700K

**007.010.WC.010.82**

GU 10-2700K - Max.6W  
Com Lâmp. Incluída 3W  
Branco / White  
Emb./Box Qt. 15pcs  
P.U. 37,00€

**007.010.GC.010.82**

GU10-2700K - Max.6W  
Com Lâmp. Incluída 3W  
Cinza / Grey  
Emb./Box Qt. 15pcs  
P.U. 37,00€

**007.010.BC.010.82**

GU10-2700K - Max.6W  
Com Lâmp. Incluída 3W  
Preto / Black  
Emb./Box Qt. 15pcs  
P.U. 37,00€

**007.010.AC.010.82**

GU10-2700K - Max.6W  
Com Lâmp. Incluída 3W  
Antracite / Dark Grey  
Emb./Box Qt. 15pcs  
P.U.38.000€

# Projetores Pavimento GIL





**Projektor Pavimento GU 10 Led em Resina 220-240Vac**  
**Resin In-Ground Light GU 10 Led 220-240Vac**  
**Max. 7W Led**

**VERSÃO LED / LED VERSION**

## Gil 120-Led



(Incluída Lâmpada 2700K)

Fornecido sem Lâmpada



**001.120GC.GU10**

GU 10 - Max. 7W  
 Diam. Aro 125mm  
 Caixa 142x74mm  
 Aro/Ring: Cinza / Grey  
 Emb./Box Qt. 15pcs  
**P.U. 36,00€**



**001.120BC.GU10**

GU 10 - Max. 7W  
 Diam. Aro 125mm  
 Caixa 142x74mm  
 Aro/Ring: Preto / Black  
 Emb./Box Qt. 15pcs  
**P.U. 36,00€**



**001.120AC.GU10**

GU 10 - Max. 7W  
 Diam. Aro 125mm  
 Caixa 142x74mm  
 Aro/Ring: Antracite/Dark Grey  
 Emb./Box Qt. 15pcs  
**P.U. 36,00€**



**001.120SC.GU10**

GU 10 - Max. 7W  
 Diam. Aro 125mm  
 Caixa 142x74mm  
 Aro: Inox  
 Emb./Box Qt. 15pcs  
**P.U. 40,00€**



**001.125SC.GU10**

GU 10 - Max. 7W  
 Diam. Aro 125mm  
 Caixa 142x74mm  
 Aro: Inox 316  
 Emb./Box Qt. 15pcs  
**P.U. 50,00€**

Oferta Lâmpada na cor 2700K

**001.120GC.GU10.82**

GU 10 - Max. 7W  
 C/Lâmp.Incl. 3W - 2700K  
 Diam. Aro 125mm  
 Caixa 142x74mm  
 Aro/Ring: Cinza / Grey  
 Emb./Box Qt. 15pcs  
**P.U. 36,00€**

**001.120BC.GU10.82**

GU 10 - Max. 7W  
 C/Lâmp.Incl. 3W - 2700K  
 Diam. Aro 125mm  
 Caixa 142x74mm  
 Aro/Ring: Preto / Black  
 Emb./Box Qt. 15pcs  
**P.U. 36,00€**

**001.120AC.GU10.82**

GU 10 - Max. 7W  
 C/Lâmp.Incl. 3W - 2700K  
 Diam. Aro 125mm  
 Caixa 142x74mm  
 Aro/Ring: Antracite/Dark Grey  
 Emb./Box Qt. 15pcs  
**P.U. 36,00€**

**001.120SC.GU10.82**

GU 10 - Max. 7W  
 C/Lâmp.Incl. 3W - 2700K  
 Diam. Aro 125mm  
 Caixa 142x74mm  
 Aro: Inox  
 Emb./Box Qt. 15pcs  
**P.U. 40,00€**

**001.125SC.GU10.82**

GU 10 - Max. 7W  
 C/Lâmp.Incl. 3W - 2700K  
 Diam. Aro 125mm  
 Caixa 142x74mm  
 Aro: Inox 316  
 Emb./Box Qt. 15pcs  
**P.U. 50,00€**

Fornecido sem Lâmpada

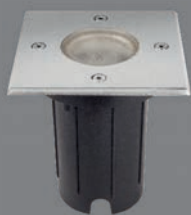

**001.121SC.GU10**

GU 10 - Max. 7W  
 Diam. Aro 125X125mm  
 Caixa 142x74mm  
 Aro/Ring: Inox  
 Emb./Box Qt. 15pcs  
**P.U. 45,00€**



**001.126SC.GU10**

GU 10 - Max. 7W  
 Diam. Aro 125X125mm  
 Caixa 142x74mm  
 Aro/Ring: Inox 316  
 Emb./Box Qt. 15pcs  
**P.U. 57,00€**



**001.122GC.GU10**

GU 10 - Max. 7W  
 Diam. Aro 125mm  
 Caixa 142x74mm  
 Aro/Ring: Cinza / Grey  
 Emb./Box Qt. 15pcs  
**P.U. 38,50€**



**001.122BC.GU10**

GU 10 - Max. 7W  
 Diam. Aro 125mm  
 Caixa 142x74mm  
 Aro/Ring: Preto / Black  
 Emb./Box Qt. 15pcs  
**P.U. 38,50€**



**001.122AC.GU10**

GU 10 - Max. 7W  
 Diam. Aro 125mm  
 Caixa 142x74mm  
 Aro/Ring: Antr. / Dark Grey  
 Emb./Box Qt. 15pcs  
**P.U. 39,50€**

Oferta Lâmpada na cor 2700K

**001.121SC.GU10.82**

GU 10 - Max. 7W  
 C/Lâmp.Incl. 3W - 2700K  
 Diam. Aro 125X125mm  
 Caixa 142x74mm  
 Aro/Ring: Inox  
 Emb./Box Qt. 15pcs  
**P.U. 45,00€**

**001.126SC.GU10.82**

GU 10 - Max. 7W  
 C/Lâmp.Incl. 3W - 2700K  
 Diam. Aro 125X125mm  
 Caixa 142x74mm  
 Aro/Ring: Inox 316  
 Emb./Box Qt. 15pcs  
**P.U. 57,00€**

**001.122GC.GU10.82**

GU 10 - Max. 7W  
 C/Lâmp.Incl. 3W - 2700K  
 Diam. Aro 125mm  
 Caixa 142x74mm  
 Aro/Ring: Cinza / Grey  
 Emb./Box Qt. 15pcs  
**P.U. 38,50€**

**001.122BC.GU10.82**

GU 10 - Max. 7W  
 C/Lâmp.Incl. 3W - 2700K  
 Diam. Aro 125mm  
 Caixa 142x74mm  
 Aro/Ring: Preto / Black  
 Emb./Box Qt. 15pcs  
**P.U. 38,50€**

**001.122AC.GU10.82**

GU 10 - Max. 7W  
 C/Lâmp.Incl. 3W - 2700K  
 Diam. Aro 125mm  
 Caixa 142x74mm  
 Aro/Ring: Antr. / Dark Grey  
 Emb./Box Qt. 15pcs  
**P.U. 39,50€**



Projektor Pavimento Led em Resina 100-240Vac  
Resin In-Ground Light Led 100-240Vac

Led: **OSRAM**

Placa Led 50 000 Horas; 2 Anos Garantia  
Led PCB 50 000 Hours; 2 Years Warranty

VERSÃO LED / LED VERSION



## Gil 190-Led



**001.190GC.LED.54**

LED-12W-1800lm-6000K  
Diam. Aro 192mm  
Caixa 271x140mm  
Aro/Ring: Cinza / Grey  
Emb./Box Qt. 8pcs  
P.U. 180,00€



**001.190BC.LED.54**

LED-12W-1800lm-6000K  
Diam. Aro 192mm  
Caixa 271x140mm  
Aro/Ring: Preto / Black  
Emb./Box Qt. 8pcs  
P.U. 180,00€



**001.190AC.LED.54**

LED-12W-1800lm-6000K  
Diam. Aro 192mm  
Caixa 271x140mm  
Aro/Ring: Antr. / Dark Grey  
Emb./Box Qt. 8pcs  
P.U. 182,00€



**001.190SC.LED.54**

LED-12W-1800lm-6000K  
Diam. Aro 192mm  
Caixa 271x140mm  
Aro/Ring: Inox  
Emb./Box Qt. 8pcs  
P.U. 215,00€



**001.195SC.LED.54**

LED-12W-1800lm-6000K  
Diam. Aro 192mm  
Caixa 271x140mm  
Aro/Ring: Inox 316  
Emb./Box Qt. 8pcs  
P.U. 250,00€

**001.190GC.LED.82**

LED-12W-1800lm-2700K  
Diam. Aro 192mm  
Caixa 271x140mm  
Aro/Ring: Cinza / Grey  
Emb./Box Qt. 8pcs  
P.U. 180,00€

**001.190BC.LED.82**

LED-12W-1800lm-2700K  
Diam. Aro 192mm  
Caixa 271x140mm  
Aro/Ring: Preto / Black  
Emb./Box Qt. 8pcs  
P.U. 180,00€

**001.190AC.LED.82**

LED-12W-1800lm-2700K  
Diam. Aro 192mm  
Caixa 271x140mm  
Aro/Ring: Antr. / Dark Grey  
Emb./Box Qt. 8pcs  
P.U. 182,00€

**001.190SC.LED.82**

LED-12W-1800lm-2700K  
Diam. Aro 192mm  
Caixa 271x140mm  
Aro/Ring: Inox  
Emb./Box Qt. 8pcs  
P.U. 215,00€

**001.195SC.LED.82**

LED-12W-1800lm-2700K  
Diam. Aro 192mm  
Caixa 271x140mm  
Aro/Ring: Inox 316  
Emb./Box Qt. 8pcs  
P.U. 250,00€

**001.190GC.LED.84**

LED-12W-1800lm-4000K  
Diam. Aro 192mm  
Caixa 271x140mm  
Aro/Ring: Cinza / Grey  
Emb./Box Qt. 8pcs  
P.U. 180,00€

**001.190BC.LED.84**

LED-12W-1800lm-4000K  
Diam. Aro 192mm  
Caixa 271x140mm  
Aro/Ring: Preto / Black  
Emb./Box Qt. 8pcs  
P.U. 180,00€

**001.190AC.LED.84**

LED-12W-1800lm-4000K  
Diam. Aro 192mm  
Caixa 271x140mm  
Aro/Ring: Antr. / Dark Grey  
Emb./Box Qt. 8pcs  
P.U. 182,00€

**001.190SC.LED.84**

LED-12W-1800lm-4000K  
Diam. Aro 192mm  
Caixa 271x140mm  
Aro/Ring: Inox  
Emb./Box Qt. 8pcs  
P.U. 215,00€

**001.195SC.LED.84**

LED-12W-1800lm-4000K  
Diam. Aro 192mm  
Caixa 271x140mm  
Aro/Ring: Inox 316  
Emb./Box Qt. 8pcs  
P.U. 250,00€



**001.191SC.LED.54**

LED-12W-1800lm-6000K  
Diam. Aro 192x192mm  
Caixa 271x140mm  
Aro/Ring: Inox  
Emb./Box Qt. 8pcs  
P.U. 235,00€



**001.196SC.LED.54**

LED-12W-1800lm-6000K  
Diam. Aro 192x192mm  
Caixa 271x140mm  
Aro/Ring: Inox 316  
Emb./Box Qt. 8pcs  
P.U. 265,00€



**001.192GC.LED.54**

LED-12W-1800lm-6000K  
Diam. Aro 192mm  
Caixa 271x140mm  
Aro/Ring: Cinza / Grey  
Emb./Box Qt. 8pcs  
P.U. 190,00€



**001.192BC.LED.54**

LED-12W-1800lm-6000K  
Diam. Aro 192mm  
Caixa 271x140mm  
Aro/Ring: Preto / Black  
Emb./Box Qt. 8pcs  
P.U. 190,00€



**001.192AC.LED.54**

LED-12W-1800lm-6000K  
Diam. Aro 192mm  
Caixa 271x140mm  
Aro/Ring: Antr./Dark Grey  
Emb./Box Qt. 8pcs  
P.U. 195,00€

**001.191SC.LED.82**

LED-12W-1800lm-2700K  
Diam. Aro 192x192mm  
Caixa 271x140mm  
Aro/Ring: Inox  
Emb./Box Qt. 8pcs  
P.U. 235,00€

**001.196SC.LED.82**

LED-12W-1800lm-2700K  
Diam. Aro 192x192mm  
Caixa 271x140mm  
Aro/Ring: Inox 316  
Emb./Box Qt. 8pcs  
P.U. 265,00€

**001.192GC.LED.82**

LED-12W-1800lm-2700K  
Diam. Aro 192mm  
Caixa 271x140mm  
Aro/Ring: Cinza / Grey  
Emb./Box Qt. 8pcs  
P.U. 190,00€

**001.192BC.LED.82**

LED-12W-1800lm-2700K  
Diam. Aro 192mm  
Caixa 271x140mm  
Aro/Ring: Preto / Black  
Emb./Box Qt. 8pcs  
P.U. 190,00€

**001.192AC.LED.82**

LED-12W-1800lm-2700K  
Diam. Aro 192mm  
Caixa 271x140mm  
Aro/Ring: Antr./Dark Grey  
Emb./Box Qt. 8pcs  
P.U. 195,00€

**001.191SC.LED.84**

LED-12W-1800lm-4000K  
Diam. Aro 192x192mm  
Caixa 271x140mm  
Aro/Ring: Inox  
Emb./Box Qt. 8pcs  
P.U. 235,00€

**001.196SC.LED.84**

LED-12W-1800lm-4000K  
Diam. Aro 192x192mm  
Caixa 271x140mm  
Aro/Ring: Inox 316  
Emb./Box Qt. 8pcs  
P.U. 265,00€

**001.192GC.LED.84**

LED-12W-1800lm-4000K  
Diam. Aro 192mm  
Caixa 271x140mm  
Aro/Ring: Cinza / Grey  
Emb./Box Qt. 8pcs  
P.U. 190,00€

**001.192BC.LED.84**

LED-12W-1800lm-4000K  
Diam. Aro 192mm  
Caixa 271x140mm  
Aro/Ring: Preto / Black  
Emb./Box Qt. 8pcs  
P.U. 190,00€

**001.192AC.LED.84**

LED-12W-1800lm-4000K  
Diam. Aro 192mm  
Caixa 271x140mm  
Aro/Ring: Antr./Dark Grey  
Emb./Box Qt. 8pcs  
P.U. 195,00€



**Projektor Pavimento Led em Resina 100-240Vac  
Resin In-Ground Light Led 100-240Vac**

**Led: OSRAM**

**Placa Led 50 000 Horas; 2 Anos Garantia  
Led PCB 50 000 Hours; 2 Years Warranty**

**Gil 230-Led**

**VERSÃO LED / LED VERSION**



**001.230GC.LED.54**

LED-25W-3000lm-6000K  
Diam. Aro 228mm  
Caixa 265x175mm  
Aro/Ring: Cinza / Grey  
Emb./Box Qt. 1pcs  
**P.U. 240,00€**



**001.230BC.LED.54**

LED-25W-3000lm-6000K  
Diam. Aro 228mm  
Caixa 265x175mm  
Aro/Ring: Preto / Black  
Emb./Box Qt. 1pcs  
**P.U. 240,00€**



**001.230AC.LED.54**

LED-25W-3000lm-6000K  
Diam. Aro 228mm  
Caixa 265x175mm  
Aro/Ring: Antr. / Dark Grey  
Emb./Box Qt. 1pcs  
**P.U. 242,00€**



**001.230SC.LED.54**

LED-25W-3000lm-6000K  
Diam. Aro 228mm  
Caixa 265x175mm  
Aro/Ring: Inox  
Emb./Box Qt. 1pcs  
**P.U. 270,00€**



**001.235SC.LED.54**

LED-25W-3000lm-6000K  
Diam. Aro 228mm  
Caixa 265x175mm  
Aro/Ring: Inox 316  
Emb./Box Qt. 1pcs  
**P.U. 295,00€**

**001.230GC.LED.82**

LED-25W-3000lm-2700K  
Diam. Aro 228mm  
Caixa 265x175mm  
Aro/Ring: Cinza / Grey  
Emb./Box Qt. 1pcs  
**P.U. 240,00€**

**001.230BC.LED.82**

LED-25W-3000lm-2700K  
Diam. Aro 228mm  
Caixa 265x175mm  
Aro/Ring: Preto / Black  
Emb./Box Qt. 1pcs  
**P.U. 240,00€**

**001.230AC.LED.82**

LED-25W-3000lm-2700K  
Diam. Aro 228mm  
Caixa 265x175mm  
Aro/Ring: Antr. / Dark Grey  
Emb./Box Qt. 1pcs  
**P.U. 242,00€**

**001.230SC.LED.82**

LED-25W-3000lm-2700K  
Diam. Aro 228mm  
Caixa 265x175mm  
Aro/Ring: Inox  
Emb./Box Qt. 1pcs  
**P.U. 270,00€**

**001.235SG.LED.82**

LED-25W-3000lm-2700K  
Diam. Aro 228mm  
Caixa 265x175mm  
Aro/Ring: Inox 316  
Emb./Box Qt. 1pcs  
**P.U. 295,00€**

**001.230GC.LED.84**

LED-25W-3000lm-4000K  
Diam. Aro 228mm  
Caixa 265x175mm  
Aro/Ring: Cinza / Grey  
Emb./Box Qt. 1cs  
**P.U. 240,00€**

**001.230BC.LED.84**

LED-25W-3000lm-4000K  
Diam. Aro 228mm  
Caixa 265x175mm  
Aro/Ring: Preto / Black  
Emb./Box Qt. 1pcs  
**P.U. 240,00€**

**001.230AC.LED.84**

LED-25W-3000lm-4000K  
Diam. Aro 228mm  
Caixa 265x175mm  
Aro/Ring: Antr. / Dark Grey  
Emb./Box Qt. 1pcs  
**P.U. 242,00€**

**001.230SC.LED.84**

LED-25W-3000lm-4000K  
Diam. Aro 228mm  
Caixa 265x175mm  
Aro/Ring: Inox  
Emb./Box Qt. 1pcs  
**P.U. 270,00€**

**001.235SG.LED.84**

LED-25W-3000lm-4000K  
Diam. Aro 228mm  
Caixa 265x175mm  
Aro/Ring: Inox 316  
Emb./Box Qt. 1pcs  
**P.U. 295,00€**

**Projektor Pavimento Orientável 25° Redondo 228mm em Resina 100/240 Vac  
Resin In-Ground light 228mm 100/240 Vac**

**Gil 230-Led Orientável**



**001.231GC.LED.54**

LED-12W-1800lm-6000K  
Diam. Aro 228mm  
Caixa 265x175mm  
Aro/Ring: Cinza / Grey  
Emb./Box Qt. 1pcs  
**P.U. 240,00€**



**001.231BC.LED.54**

LED-12W-1800lm-6000K  
Diam. Aro 228mm  
Caixa 265x175mm  
Aro/Ring: Preto / Black  
Emb./Box Qt. 1pcs  
**P.U. 240,00€**



**001.231AC.LED.54**

LED-12W-1800lm-6000K  
Diam. Aro 228mm  
Caixa 265x175mm  
Aro/Ring: Antr. / Dark Grey  
Emb./Box Qt. 1pcs  
**P.U. 245,00€**



**001.231SC.LED.54**

LED-12W-1800lm-6000K  
Diam. Aro 228mm  
Caixa 265x175mm  
Aro/Ring: Inox  
Emb./Box Qt. 1pcs  
**P.U. 270,00€**



**001.237SC.LED.54**

LED-12W-1800lm-6000K  
Diam. Aro 228mm  
Caixa 265x175mm  
Aro/Ring: Inox 316  
Emb./Box Qt. 1pcs  
**P.U. 296,00€**

**001.231GC.LED.82**

LED-12W-1800lm-2700K  
Diam. Aro 228mm  
Caixa 265x175mm  
Aro/Ring: Cinza / Grey  
Emb./Box Qt. 1pcs  
**P.U. 240,00€**

**001.231BC.LED.82**

LED-12W-1800lm-2700K  
Diam. Aro 228mm  
Caixa 265x175mm  
Aro/Ring: Preto / Black  
Emb./Box Qt. 1pcs  
**P.U. 240,00€**

**001.231AC.LED.82**

LED-12W-1800lm-2700K  
Diam. Aro 228mm  
Caixa 265x175mm  
Aro/Ring: Antr. / Dark Grey  
Emb./Box Qt. 1pcs  
**P.U. 245,00€**

**001.231SC.LED.82**

LED-12W-1800lm-2700K  
Diam. Aro 228mm  
Caixa 265x175mm  
Aro/Ring: Inox  
Emb./Box Qt. 1pcs  
**P.U. 270,00€**

**001.237SC.LED.82**

LED-12W-1800lm-2700K  
Diam. Aro 228mm  
Caixa 265x175mm  
Aro/Ring: Inox 316  
Emb./Box Qt. 1pcs  
**P.U. 296,00€**

**001.231GC.LED.84**

LED-12W-1800lm-4000K  
Diam. Aro 228mm  
Caixa 265x175mm  
Aro/Ring: Cinza / Grey  
Emb./Box Qt. 1pcs  
**P.U. 240,00€**

**001.231BC.LED.84**

LED-12W-1800lm-4000K  
Diam. Aro 228mm  
Caixa 265x175mm  
Aro/Ring: Preto / Black  
Emb./Box Qt. 1pcs  
**P.U. 240,00€**

**001.231AC.LED.84**

LED-12W-1800lm-4000K  
Diam. Aro 228mm  
Caixa 265x175mm  
Aro/Ring: Antr. / Dark Grey  
Emb./Box Qt. 1pcs  
**P.U. 245,00€**

**001.231SC.LED.84**

LED-12W-1800lm-4000K  
Diam. Aro 228mm  
Caixa 265x175mm  
Aro/Ring: Inox  
Emb./Box Qt. 1pcs  
**P.U. 270,00€**

**001.237SC.LED.84**

LED-12W-1800lm-4000K  
Diam. Aro 228mm  
Caixa 265x175mm  
Aro/Ring: Inox 316  
Emb./Box Qt. 1pcs  
**P.U. 296,00€**

# Gil 190/230-E27

soflight®



VERSÃO E27 / E27 VERSION

Projektor Pavimento E27 em Resina 220-240Vac  
Resin In-Ground Light E27 220-240Vac



(Não Incluída)

## Gil 190-E27



**001.190GC.E27**

E27 - Max. 20W  
Diam. Aro 192mm  
Caixa 271x140mm  
Aro/Ring: Cinza / Grey  
Emb./Box Qt. 8pcs  
P.U. 64,00€



**001.190BC.E27**

E27 - Max. 20W  
Diam. Aro 192mm  
Caixa 271x140mm  
Aro/Ring: Preto / Black  
Emb./Box Qt. 8pcs  
P.U. 64,00€



**001.190AC.E27**

E27 - Max. 20W  
Diam. Aro 192mm  
Caixa 271x140mm  
Aro/Ring: Antr. / Dark Grey  
Emb./Box Qt. 8pcs  
P.U. 65,00€



**001.190SC.E27**

E27 - Max. 20W  
Diam. Aro 192mm  
Caixa 271x140mm  
Aro/Ring: Inox  
Emb./Box Qt. 8pcs  
P.U. 79,00€



**001.195SC.E27**

E27 - Max. 20W  
Diam. Aro 192mm  
Caixa 271x140mm  
Aro/Ring: Inox 316  
Emb./Box Qt. 8pcs  
P.U. 92,50€

## Gil 190-E27



**001.192GC.E27**

E27 - Max. 20W  
Diam. Aro 192mm  
Caixa 271x140mm  
Aro/Ring: Cinza / Grey  
Emb./Box Qt. 8pcs  
P.U. 66,00€



**001.192BC.E27**

E27 - Max. 20W  
Diam. Aro 192mm  
Caixa 271x140mm  
Aro/Ring: Preto / Black  
Emb./Box Qt. 8pcs  
P.U. 66,00€



**001.192AC.E27**

E27 - Max. 20W  
Diam. Aro 192mm  
Caixa 271x140mm  
Aro/Ring: Antr. / Dark Grey  
Emb./Box Qt. 8pcs  
P.U. 68,00€



**001.191SC.E27**

E27 - Max. 20W  
Diam. Aro 192x192mm  
Caixa 271x140mm  
Aro/Ring: Inox  
Emb./Box Qt. 8pcs  
P.U. 90,00€



**001.196SC.E27**

E27 - Max. 20W  
Diam. Aro 192x192mm  
Caixa 271x140mm  
Aro/Ring: Inox 316  
Emb./Box Qt. 8pcs  
P.U. 110,00€

Projektor Pavimento 228mm E27 em Resina 240Vac  
Resin In-Ground Light 228mm E27 240Vac

## Gil 230-E27



**001.230GC.E27**

E27 - Max. 20W  
Diam. Aro 228mm  
Caixa 265x175mm  
Aro/Ring: Cinza / Grey  
Emb./Box Qt. 1pcs  
P.U. 75,00€



**001.230BC.E27**

E27 - Max. 20W  
Diam. Aro 228mm  
Caixa 265x175mm  
Aro/Ring: Preto / Black  
Emb./Box Qt. 1pcs  
P.U. 75,00€



**001.230AC.E27**

E27 - Max. 20W  
Diam. Aro 228mm  
Caixa 265x175mm  
Aro/Ring: Antr. / Dark Grey  
Emb./Box Qt. 1pcs  
P.U. 77,00€



**001.230SC.E27**

E27 - Max. 20W  
Diam. Aro 228mm  
Caixa 265x175mm  
Aro/Ring: Inox  
Emb./Box Qt. 1pcs  
P.U. 110,00€



**001.235SC.E27**

E27 - Max. 20W  
Diam. Aro 228mm  
Caixa 265x175mm  
Aro/Ring: Inox 316  
Emb./Box Qt. 1pcs  
P.U. 145,00€

# Apliques Muro CLARA

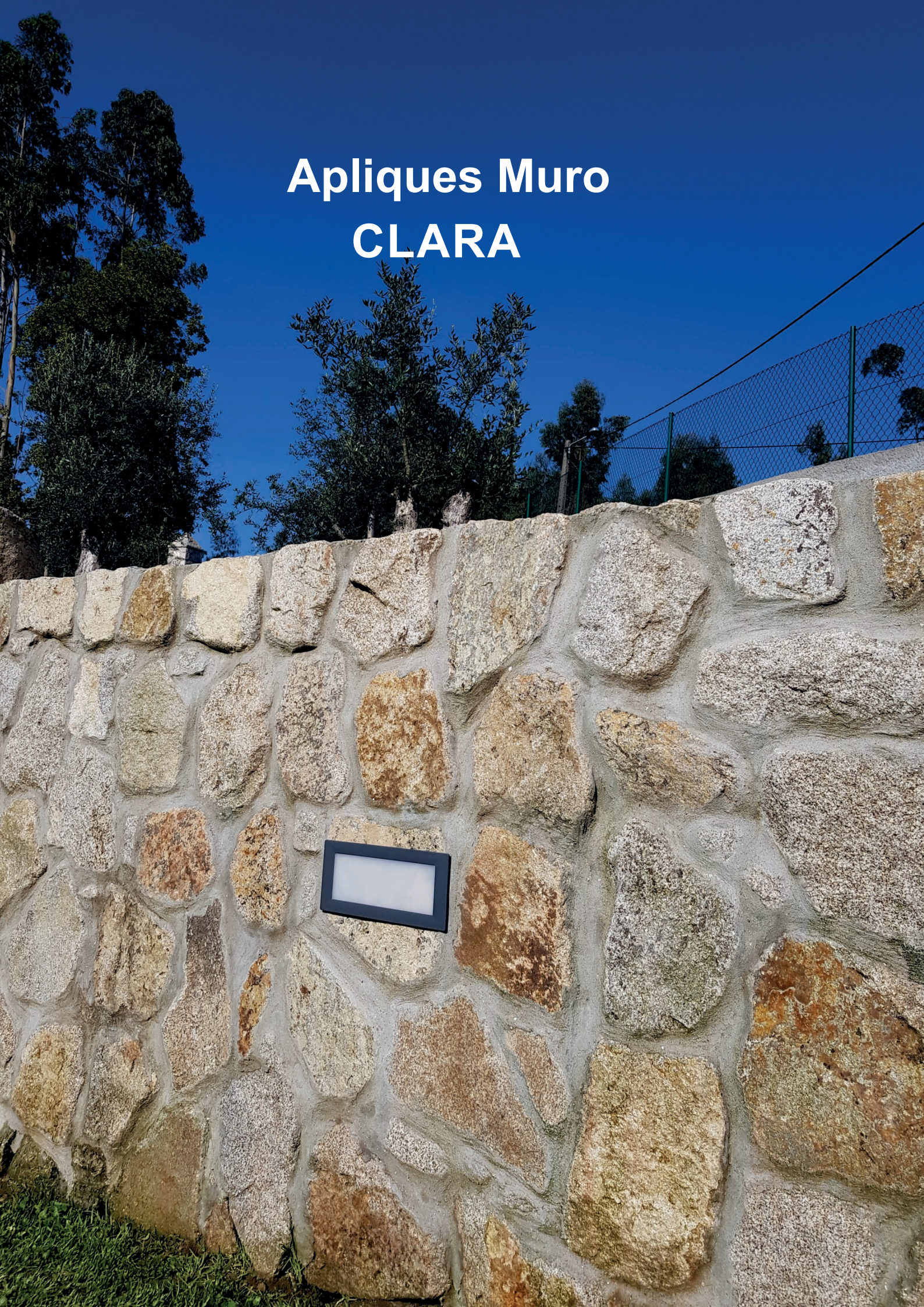



Aplique Muro em Resina com Difusor Opalino em PMMA, 220-240Vac  
Resin Recessed Wall, Opal Diffuser, PMMA, 220-240Vac

VERSÃO LED / LED VERSION

Led: **OSRAM**

Placa Led 50 000 Horas; 2 Anos Garantia  
Led PCB 50 000 Hours; 2 Years Warranty



(Incluída)

## Clara 85-Led

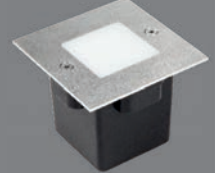
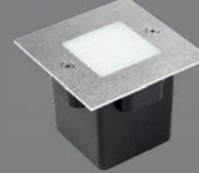
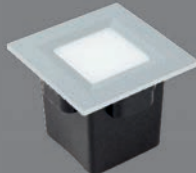
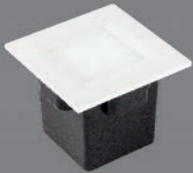

**004.011.WO.LED-82**

LED-2W-250lm-2700K  
Aro/Ring 85X85mm  
Cx/Box: 78x78x66mm  
Aro/Ring: Branco / White  
Emb./Box Qt. 20pcs  
P.U. 34,00€

**004.011.GO.LED-82**

LED-2W-250lm-2700K  
Aro/Ring 85X85mm  
Cx/Box: 78x78x66mm  
Aro/Ring: Cinza / Grey  
Emb./Box Qt. 20pcs  
P.U. 34,00€

**004.011.BO.LED-82**

LED-2W-250lm-2700K  
Aro/Ring 85X85mm  
Cx/Box: 78x78x66mm  
Aro/Ring: Preto / Black  
Emb./Box Qt. 20pcs  
P.U. 34,00€

**004.011.AO.LED-82**

LED-2W-250lm-2700K  
Aro/Ring 85X85mm  
Cx/Box: 78x78x66mm  
Aro/Ring: Antr./Dark Grey  
Emb./Box Qt. 20pcs  
P.U. 35,00€

**004.011.SO.LED-82**

LED-2W-250lm-2700K  
Aro/Ring 85X85mm  
Cx/Box: 78x78x66mm  
Aro/Ring: Inox  
Emb./Box Qt. 20pcs  
P.U. 41,00€

**004.017.SO.LED-82**

LED-2W-250lm-2700K  
Aro/Ring 85X85mm  
Cx/Box: 78x78x66mm  
Aro/Ring: Inox 316  
Emb./Box Qt. 20pcs  
P.U. 44,00€

**004.011.WO.LED-84**

LED-2W-250lm-4000K  
Aro/Ring 85x85mm  
Cx/Box: 78x78x66mm  
Aro/Ring: Branco / White  
Emb./Box Qt. 20pcs  
P.U. 34,00€

**004.011.GO.LED-84**

LED-2W-250lm-4000K  
Aro/Ring 85x85mm  
Cx/Box: 78x78x66mm  
Aro/Ring: Cinza / Grey  
Emb./Box Qt. 20pcs  
P.U. 34,00€

**004.011.BO.LED-84**

LED-2W-250lm-4000K  
Aro/Ring 85x85mm  
Cx/Box: 78x78x66mm  
Aro/Ring: Preto / Black  
Emb./Box Qt. 20pcs  
P.U. 34,00€

**004.011.AO.LED-84**

LED-2W-250lm-4000K  
Aro/Ring 85x85mm  
Cx/Box: 78x78x66mm  
Aro/Ring: Antr./Dark Grey  
Emb./Box Qt. 20pcs  
P.U. 35,00€

**004.011.SO.LED-84**

LED-2W-250lm-4000K  
Aro/Ring 85x85mm  
Cx/Box: 78x78x66mm  
Aro/Ring: Inox  
Emb./Box Qt. 20pcs  
P.U. 41,00€

**004.017.SO.LED-84**

LED-2W-250lm-4000K  
Aro/Ring 85x85mm  
Cx/Box: 78x78x66mm  
Aro/Ring: Inox 316  
Emb./Box Qt. 20pcs  
P.U. 44,00€

## Clara 97-Led

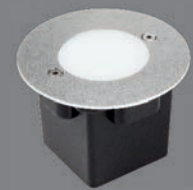
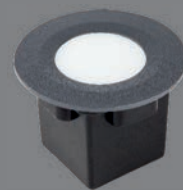

**004.021.WO.LED-82**

LED-2W-250lm-2700K  
Aro/Ring 97mm  
Cx/Box: 78x78x66mm  
Aro/Ring: Branco / White  
Emb./Box Qt. 20pcs  
P.U. 34,00€

**004.021.GO.LED-82**

LED-2W-250lm-2700K  
Aro/Ring 97mm  
Cx/Box: 78x78x66mm  
Aro/Ring: Cinza / Grey  
Emb./Box Qt. 20pcs  
P.U. 34,00€

**004.021.BO.LED-82**

LED-2W-250lm-2700K  
Aro/Ring 97mm  
Cx/Box: 78x78x66mm  
Aro/Ring: Preto / Black  
Emb./Box Qt. 20pcs  
P.U. 34,00€

**004.021.AO.LED-82**

LED-2W-250lm-2700K  
Aro/Ring 97mm  
Cx/Box: 78x78x66mm  
Aro/Ring: Antr./Dark Grey  
Emb./Box Qt. 20pcs  
P.U. 35,00€

**004.021.SO.LED-82**

LED-2W-250lm-2700K  
Aro/Ring 97mm  
Cx/Box: 78x78x66mm  
Aro/Ring: Inox  
Emb./Box Qt. 20pcs  
P.U. 41,00€

**004.027.SO.LED-82**

LED-2W-250lm-2700K  
Aro/Ring 97mm  
Cx/Box: 78x78x66mm  
Aro/Ring: Inox 316  
Emb./Box Qt. 20pcs  
P.U. 44,00€

**004.021.WO.LED-84**

LED-2W-250lm-4000K  
Aro/Ring 97mm  
Cx/Box: 78x78x66mm  
Aro/Ring: Branco / White  
Emb./Box Qt. 20pcs  
P.U. 34,00€

**004.021.GO.LED-84**

LED-2W-250lm-4000K  
Aro/Ring 97mm  
Cx/Box: 78x78x66mm  
Aro/Ring: Cinza / Grey  
Emb./Box Qt. 20pcs  
P.U. 34,00€

**004.021.BO.LED-84**

LED-2W-250lm-4000K  
Aro/Ring 97mm  
Cx/Box: 78x78x66mm  
Aro/Ring: Preto / Black  
Emb./Box Qt. 20pcs  
P.U. 34,00€

**004.021.AO.LED-84**

LED-2W-250lm-4000K  
Aro/Ring 97mm  
Cx/Box: 78x78x66mm  
Aro/Ring: Antr./Dark Grey  
Emb./Box Qt. 20pcs  
P.U. 35,00€

**004.021.SO.LED-84**

LED-2W-250lm-4000K  
Aro/Ring 97mm  
Cx/Box: 78x78x66mm  
Aro/Ring: Inox  
Emb./Box Qt. 20pcs  
P.U. 41,00€

**004.027.SO.LED-84**

LED-2W-250lm-4000K  
Aro/Ring 97mm  
Cx/Box: 78x78x66mm  
Aro/Ring: Inox 316  
Emb./Box Qt. 20pcs  
P.U. 44,00€

**VERSÃO LED / LED VERSION**

Aplique Muro em Resina com Difusor Opalino em PMMA, 220-240Vac  
Resin Recessed Wall, Opal Diffuser, PMMA, 220-240Vac

**Led: OSRAM**

Placa Led 50 000 Horas; 2 Anos Garantia  
Led PCB 50 000 Hours; 2 Years Warranty

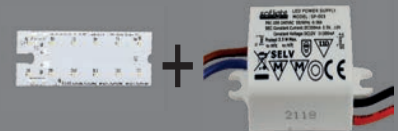

(Incluída)

### Clara 170-Led



004.031.WO.LED-82	004.031.GO.LED-82	004.031.BO.LED-82	004.031.AO.LED-82	004.031.SO.LED-82	004.037.SO.LED-82
LED-2,1W-300lm-2700K Aro/Ring 163x78mm Cx/Box:156x72x66mm Aro/Ring: Branco / White Emb./Box Qt. 20pcs P.U. 37,00€	LED-2,1W-300lm-2700K Aro/Ring 163X78mm Cx/Box:156X72X66mm Aro/Ring: Cinza / Grey Emb./Box Qt. 20pcs P.U. 37,00€	LED-2,1W-300lm-2700K Aro/Ring 163X78mm Cx/Box:156X72X66mm Aro/Ring: Preto / Black Emb./Box Qt. 20pcs P.U. 37,00€	LED-2,1W-300lm-2700K Aro/Ring 163X78mm Cx/Box:156X72X66mm Aro/Ring: Ant./Dark Grey Emb./Box Qt. 20pcs P.U. 39,00€	LED-2,1W-300lm-2700K Aro/Ring 163X78mm Cx/Box:156X72X66mm Aro/Ring: Inox Emb./Box Qt. 20pcs P.U. 45,00€	LED-2,1W-300lm-2700K Aro/Ring 163X78mm Cx/Box:156X72X66mm Aro/Ring: Inox 316 Emb./Box Qt. 20pcs P.U. 49,00€

004.031.WO.LED-84	004.031.GO.LED-84	004.031.BO.LED-84	004.031.AO.LED-84	004.031.SO.LED-84	004.037.SO.LED-84
LED-2,1W-300lm-4000K Aro/Ring 163x78mm Cx/Box 156x72x66mm Aro/Ring: Branco / White Emb./Box Qt. 20pcs P.U. 37,00€	LED-2,1W-300lm-4000K Aro/Ring 163X78mm Cx/Box 156X72X66mm Aro/Ring: Cinza / Grey Emb./Box Qt. 20pcs P.U. 37,00€	LED-2,1W-300lm-4000K Aro/Ring 163X78mm Cx/Box 156X72X66mm Aro/Ring: Preto / Black Emb./Box Qt. 20pcs P.U. 37,00€	LED-2,1W-300lm-4000K Aro/Ring 163X78mm Cx/Box 156X72X66mm Aro/Ring:Ant./Dark Grey Emb./Box Qt. 20pcs P.U. 39,00€	LED-2,1W-300lm-4000K Aro/Ring 163X78mm Cx/Box 156X72X66mm Aro/Ring: Inox Emb./Box Qt. 20pcs P.U. 45,00€	LED-2,1W-300lm-4000K Aro/Ring 163X78mm Cx/Box 156X72X66mm Aro/Ring: Inox 316 Emb./Box Qt. 20pcs P.U. 49,00€

# Clara 245-E27 / Led

soflight®



VERSÃO E27 / E27 VERSION

Aplique Muro em Resina com Difusor Opalino em PMMA, 220-240Vac  
Resin Recessed Wall, Opal Diffuser, PMMA, 220-240Vac

## Clara 245 - E27

( Caixa/negativo (004.049.B.O.CX) não Incluída )



(Não Incluída)

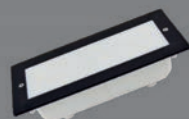

**004.040.WO.E27**

E27 - Max.15W  
Aro/Ring 248x106mm  
Cx/Box:224,5x84x69mm  
Aro/Ring: Branco / White  
Emb./Box Qt. 20pcs  
P.U. 17,00€

**004.040.GO.E27**

E27 - Max. 15W  
Aro/Ring 248x106mm  
Cx/Box:224,5x84x69mm  
Aro/Ring: Cinza / Grey  
Emb./Box Qt. 20pcs  
P.U. 17,00€

**004.040.BO.E27**

E27 - Max. 15W  
Aro/Ring 248x106mm  
Cx/Box:224,5x84x69mm  
Aro/Ring: Preto / Black  
Emb./Box Qt. 20pcs  
P.U. 17,00€

**004.040.AO.E27**

E27 - Max. 15W  
Aro/Ring 248x106mm  
Cx/Box:224,5x84x69mm  
Aro/Ring: Ant./Dark Grey  
Emb./Box Qt. 20pcs  
P.U. 18,00€

**004.040.SO.E27**

E27 - Max. 15W  
Aro/Ring 250x110mm  
Cx/Box:224,5x84x69mm  
Aro/Ring: Inox  
Emb./Box Qt. 20pcs  
P.U. 22,00€

**004.045.SO.E27**

E27 - Max.15W  
Aro/Ring 250x110mm  
Cx/Box:224,5x84x69mm  
Aro/Ring: Inox 316  
Emb./Box Qt. 20pcs  
P.U. 28,00€

## Opção Casambi e Dali por Encomenda

CASAMBI



Led: **OSRAM**

Placa Led 50 000 Horas; 2 Anos Garantia  
Led PCB 50 000 Hours; 2 Years Warranty

VERSÃO LED / LED VERSION

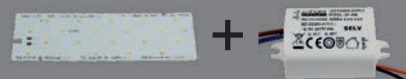

(Incluída)

## Clara 245 - Led

( Caixa/negativo (004.049.B.O.CX) não Incluída )

**004.040.WO.LED.82**

5,5W-810lm-2700K  
Aro/Ring 248x106mm  
Cx/Box:224,5x84x69mm  
Aro/Ring: Branco / White  
Emb./Box Qt. 20pcs  
P.U. 32,00€

**004.040.GO.LED.82**

5,5W-810lm-2700K  
Aro/Ring 248x106mm  
Cx/Box:224,5x84x69mm  
Aro/Ring: Cinza / Grey  
Emb./Box Qt. 20pcs  
P.U. 32,00€

**004.040.BO.LED.82**

5,5W-810lm-2700K  
Aro/Ring 248x106mm  
Cx/Box:224,5x84x69mm  
Aro/Ring: Preto / Black  
Emb./Box Qt. 20pcs  
P.U. 32,00€

**004.040.AO.LED.82**

5,5W-810lm-2700K  
Aro/Ring 248x106mm  
Cx/Box:224,5x84x69mm  
Aro/Ring: Ant./Dark Grey  
Emb./Box Qt. 20pcs  
P.U. 33,00€

**004.040.SO.LED.82**

5,5W-810lm-2700K  
Aro/Ring 250x110mm  
Cx/Box:224,5x84x69mm  
Aro/Ring: Inox  
Emb./Box Qt. 20pcs  
P.U. 41,00€

**004.045.SO.LED.82**

5,5W-810lm-2700K  
Aro/Ring 250x110mm  
Cx/Box:224,5x84x69mm  
Aro/Ring: Inox 316  
Emb./Box Qt. 20pcs  
P.U. 50,00€

**004.040.WO.LED.84**

5,5W-810lm-4000K  
Aro/Ring 248x106mm  
Cx/Box:224,5x84x69mm  
Aro/Ring: Branco / White  
Emb./Box Qt. 20pcs  
P.U. 32,00€

**004.040.GO.LED.84**

5,5W-810lm-4000K  
Aro/Ring 248x106mm  
Cx/Box:224,5x84x69mm  
Aro/Ring: Cinza / Grey  
Emb./Box Qt. 20pcs  
P.U. 32,00€

**004.040.BO.LED.84**

5,5W-810lm-4000K  
Aro/Ring 248x106mm  
Cx/Box:224,5x84x69mm  
Aro/Ring: Preto / Black  
Emb./Box Qt. 20pcs  
P.U. 32,00€

**004.040.AO.LED.84**

5,5W 810lm-4000K  
Aro/Ring 248x106mm  
Cx/Box:224,5x84x69mm  
Aro/Ring: Ant./Dark Grey  
Emb./Box Qt. 20pcs  
P.U. 33,00€

**004.040.SO.LED.84**

5,5W-810lm-4000K  
Aro/Ring 250x110mm  
Cx/Box:224,5x84x69mm  
Aro/Ring: Inox  
Emb./Box Qt. 20pcs  
P.U. 41,00€

**004.045.SO.LED.84**

5,5W-810lm-4000K  
Aro/Ring 250x110mm  
Cx/Box:224,5x84x69mm  
Aro/Ring: Inox 316  
Emb./Box Qt. 20pcs  
P.U. 50,00€

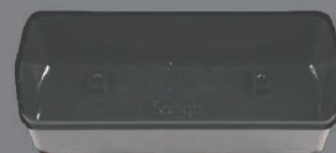
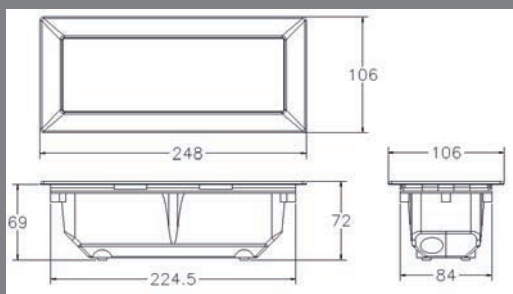

**004.049.B.O.CX**

Caixa para Aplique Muro  
Clara 245  
Emb./Box Qt. 150 pcs  
P.U. 1,80€



Opção Casambi e Dali por Encomenda

CASAMBI



Aplique Muro em Resina com Difusor Opalino em PMMA, 220-240Vac  
Resin Recessed Wall, Opal Diffuser, PMMA, 220-240Vac

VERSÃO LED / LED VERSION

Led: **OSRAM**

Placa Led 50 000 Horas; 2 Anos Garantia  
Led PCB 50 000 Hours; 2 Years Warranty



(Incluída)

Clara 300-Led



**004.050.WO.L15.82**

6,5W-1000lm-2700K  
Aro/Ring 294x124mm  
Cx/Box:282x112x97mm  
Aro/Ring: Branco / White  
Emb./Box Qt. 21pcs  
P.U. 39,00€

**004.050.GO.L15.82**

6,5W-1000lm-2700K  
Aro/Ring 294x124mm  
Cx/Box:282x112x97mm  
Aro/Ring: Cinza / Grey  
Emb./Box Qt. 21pcs  
P.U. 39,00€

**004.050.BO.L15.82**

6,5W-1000lm-2700K  
Aro/Ring 294x124mm  
Cx/Box:282x112x97mm  
Aro/Ring: Preto / Black  
Emb./Box Qt. 21pcs  
P.U. 39,00€

**004.050.AO.L15.82**

6,5W-1000lm-2700K  
Aro/Ring 294x124mm  
Cx/Box:282x112x97mm  
Aro/Ring: Ant./Dark Grey  
Emb./Box Qt. 21pcs  
P.U. 40,00€

**004.050.SO.L15.82**

6,5W-1000lm-2700K  
Aro/Ring 294x124mm  
Cx/Box:282x112x97mm  
Aro/Ring: Inox  
Emb./Box Qt. 21pcs  
P.U. 47,00€

**004.055.SO.L15.82**

6,5W-1000lm-2700K  
Aro/Ring 294x124mm  
Cx/Box:282x112x97mm  
Aro/Ring: Inox 316  
Emb./Box Qt. 21pcs  
P.U. 55,00€

**004.050.WO.L15.84**

6,5W-1000lm-4000K  
Aro/Ring 294x124mm  
Cx/Box 282x112x97mm  
Aro/Ring: Branco / White  
Emb./Box Qt. 21pcs  
P.U. 39,00€

**004.050.GO.L15.84**

6,5W-1000lm-4000K  
Aro/Ring 294x124mm  
Cx/Box 282x112x97mm  
Aro/Ring: Cinza / Grey  
Emb./Box Qt. 21pcs  
P.U. 39,00€

**004.050.BO.L15.84**

6,5-1000lm-4000K  
Aro/Ring 294x124mm  
Cx/Box 282x112x97mm  
Aro/Ring: Preto / Black  
Emb./Box Qt. 21pcs  
P.U. 39,00€

**004.050.AO.L15.84**

6,5W-1000lm-4000K  
Aro/Ring 294x124mm  
Cx/Box 282x112x97mm  
Aro/Ring: Ant./Dark Grey  
Emb./Box Qt. 21pcs  
P.U. 40,00€

**004.050.SO.L15.84**

6,5W-1000lm-4000K  
Aro/Ring 294x124mm  
Cx/Box 282x112x97mm  
Aro/Ring: Inox  
Emb./Box Qt. 21pcs  
P.U. 47,00€

**004.055.SO.L15.84**

6,5W-1000lm-4000K  
Aro/Ring 294x124mm  
Cx/Box 282x112x97mm  
Aro/Ring: Inox 316  
Emb./Box Qt. 21pcs  
P.U. 55,00€

Aplique Muro em Resina E27, Max. 26W com Difusor Opalino em PMMA  
Resin Recessed Wall E27, Opal Diffuser, PMMA

VERSÃO E27 / E27 VERSION

( Sem Lâmpada )

Clara 300-E27



**004.050.WO.E27**

E27 - Max.26w - 4200K  
Aro/Ring 294x124mm  
Cx/Box:282x112x97mm  
Aro/Ring: Branco / White  
Emb./Box Qt. 21pcs  
P.U. 20,50€

**004.050.GO.E27**

E27 - Max.26w - 4200K  
Aro/Ring 294x124mm  
Cx/Box:282x112x97mm  
Aro/Ring: Cinza / Grey  
Emb./Box Qt. 21pcs  
P.U. 20,50€

**004.050.BO.E27**

E27 - Max.26W - 4200K  
Aro/Ring 294x124mm  
Cx/Box:282x112x97mm  
Aro/Ring: Preto / Black  
Emb./Box Qt. 21pcs  
P.U. 20,50€

**004.050.AO.E27**

E27 - Max.26W - 4200K  
Aro/Ring 294x124mm  
Cx/Box:282x112x97mm  
Aro/Ring: Ant./Dark Grey  
Emb./Box Qt. 21pcs  
P.U. 22,00€

**004.050.SO.E27**

E27 - Max.26W - 4200K  
Aro/Ring 294x124mm  
Cx/Box:282x112x97mm  
Aro/Ring: Inox  
Emb./Box Qt. 21pcs  
P.U. 26,00€

**004.055.SO.E27**

E27 - Max.26W - 4200K  
Aro/Ring 294x124mm  
Cx/Box:282x112x97mm  
Aro/Ring: Inox 316  
Emb./Box Qt. 21pcs  
P.U. 43,00€

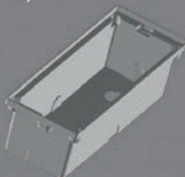

**004.059.B.O.CX**

Cx. p/Aplique Clara 300  
Cx/Box:282x112x97mm  
Cor: Preto  
Emb./Box Qt. 21pcs  
P.U. 2,55€

# Balizadores Redondos ZEZA-RD





(Não Incluída)

Balizador Redondo em Resina , Difusor PMMA  
Round Bollard Resin Material , Diffuser PMMA  
220-240Vac - Max. 18W Led E27 - IP 54



**003.210WO.E27**

Balizador redondo S/Lâmp.  
Base: 116mm  
Diam.90mm/Alt.286mm  
Cor: Branco / White  
Difusor: Opalino/Opal  
Emb./Box Qt. 1pcs  
P.U. 30,00€



**003.210GO.E27**

Balizador redondo S/Lâmp.  
Base: 116mm  
Diam.90mm/Alt.286mm  
Cor: Cinza / Grey  
Difusor: Opalino/Opal  
Emb./Box Qt. 1pcs  
P.U. 30,00€



**003.210BO.E27**

Balizador redondo S/Lâmp.  
Base: 116mm  
Diam.90mm/Alt.286mm  
Cor: Preto / Black  
Difusor: Opalino/Opal  
Emb./Box Qt. 1pcs  
P.U. 30,00€



**003.210AO.E27**

Balizador redondo S/Lâmp.  
Base: 116mm  
Diam.90mm/Alt.286mm  
Cor: Antracite / Dark Grey  
Difusor: Opalino/Opal  
Emb./Box Qt. 1pcs  
P.U. 31,00€



**003.220WO.E27**

Balizador redondo S/Lâmp.  
Base: 116mm  
Diam.90mm/Alt.411mm  
Cor: Branco / White  
Difusor: Opalino/Opal  
Emb./Box Qt. 1pcs  
P.U. 35,00€



**003.220GO.E27**

Balizador redondo S/Lâmp.  
Base: 116mm  
Diam.90mm/Alt.411mm  
Cor: Cinza / Grey  
Difusor: Opalino/Opal  
Emb./Box Qt. 1pcs  
P.U. 35,00€



**003.220BO.E27**

Balizador redondo S/Lâmp.  
Base: 116mm  
Diam.90mm/Alt.411mm  
Cor: Preto / Black  
Difusor: Opalino/Opal  
Emb./Box Qt. 1pcs  
P.U. 35,00€



**003.220AO.E27**

Balizador redondo S/Lâmp.  
Base: 116mm  
Diam.90mm/Alt.411mm  
Cor: Antracite / Dark Grey  
Difusor: Opalino/Opal  
Emb./Box Qt. 1pcs  
P.U. 36,00€



**003.230WO.E27**

Balizador redondo S/Lâmp.  
Base: 116mm  
Diam.90mm/Alt.581mm  
Cor: Branco / White  
Difusor: Opalino/Opal  
Emb./Box Qt. 1pcs  
P.U. 40,00€



**003.230GO.E27**

Balizador redondo S/Lâmp.  
Base: 116mm  
Diam.90mm/Alt.581mm  
Cor: Cinza / Grey  
Difusor: Opalino/Opal  
Emb./Box Qt. 1pcs  
P.U. 40,00€



**003.230BO.E27**

Balizador redondo S/Lâmp.  
Base: 116mm  
Diam.90mm/Alt.581mm  
Cor: Preto / Black  
Difusor: Opalino/Opal  
Emb./Box Qt. 1pcs  
P.U. 40,00€



**003.230AO.E27**

Balizador redondo S/Lâmp.  
Base: 116mm  
Diam.90mm/Alt.581mm  
Cor: Antracite / Dark Grey  
Difusor: Opalino/Opal  
Emb./Box Qt. 1pcs  
P.U. 42,00€



**003.240WO.E27**

Balizador redondo S/Lâmp.  
Base: 116mm  
Diam.90mm/Alt.290mm  
Cor: Branco / White  
Difusor: Opalino/Opal  
Emb./Box Qt. 1pcs  
P.U. 39,00€

**003.240GO.E27**

Balizador redondo S/Lâmp.  
Base: 116mm  
Diam.90mm/Alt.290mm  
Cor: Cinza / Grey  
Difusor: Opalino/Opal  
Emb./Box Qt. 1pcs  
P.U. 39,00€

**003.240BO.E27**

Balizador redondo S/Lâmp.  
Base: 116mm  
Diam.90mm/Alt.290mm  
Cor: Preto / Black  
Difusor: Opalino/Opal  
Emb./Box Qt. 1pcs  
P.U. 39,00€

**003.240AO.E27**

Balizador redondo S/Lâmp.  
Base: 116mm  
Diam.90mm/Alt.290mm  
Cor: Antracite / Dark Grey  
Difusor: Opalino/Opal  
Emb./Box Qt. 1pcs  
P.U. 41,00€

# Zeza-RD

Balizador Redondo em Resina , Difusor PMMA  
 Round Bollard Resin Material , Diffuser PMMA  
 220-240Vac - Max. 18W Led E27 - IP 54

soflight®



VERSÃO LED / LED VERSION

VERSÃO E27 / E27 VERSION

## Zeza 500 RD

Balizador Redondo 470mm em Resina , Difusor PMMA, Max.20W  
 Round Bollard 470mm Resin Material , Diffuser PMMA, Max.20W



(Não Incluídas)



(Não Incluída)



**003.110WO.E27**

E27 - Max. 18W  
 Base: 220mm  
 Diam.142mm/Alt.470mm  
 Cor: Branco / White  
 Difusor: Opalino/Opal  
 Emb./Box Qt. 1pcs  
 P.U. 90,00€



**003.110GO.E27**

E27 - Max. 18W  
 Base: 220mm  
 Diam.142mm/Alt.470mm  
 Cor: Cinza/Grey  
 Difusor: Opalino/Opal  
 Emb./Box Qt. 1pcs  
 P.U. 90,00€



**003.110BO.E27**

E27 - Max. 18W  
 Base: 220mm  
 Diam.142mm/Alt.470mm  
 Cor: Preto/Black  
 Difusor: Opalino/Opal  
 Emb./Box Qt. 1pcs  
 P.U. 90,00€



**003.110AO.E27**

E27 - Max. 18W  
 Base: 220mm  
 Diam.142mm/Alt.470mm  
 Cor: Antra. /Dark Grey  
 Difusor: Opalino/Opal  
 Emb./Box Qt. 1pcs  
 P.U. 92,00€



**003.110WO.3GU10**

LED-3xGU10-Max.12W  
 Base: 220mm  
 Diam.142mm/Alt.470mm  
 Cor: Branco / White  
 Difusor: Opalino/Opal  
 Emb./Box Qt. 1pcs  
 P.U. 105,00€



**003.110GO.3GU10**

LED-3xGU10-Max 12W  
 Base: 220mm  
 Diam.142mm/Alt.470mm  
 Cor: Cinza/Grey  
 Difusor: Opalino/Opal  
 Emb./Box Qt. 1pcs  
 P.U. 105,00€



**003.110BO.3GU10**

LED-3xGU10-Max12W  
 Base: 220mm  
 Diam.142mm/Alt.470mm  
 Cor: Preto/Black  
 Difusor: Opalino/Opal  
 Emb./Box Qt. 1pcs  
 P.U. 105,00€



**003.110AO.3GU10**

LED-3xGU10-Max.12W  
 Base: 220mm  
 Diam.142mm/Alt.470mm  
 Cor: Antrite /Dark Grey  
 Difusor: Opalino/Opal  
 Emb./Box Qt. 1pcs  
 P.U. 107,00€



**003.110WC.3GU10**

LED-3xGU10-Max.12W  
 Base: 220mm  
 Diam.142mm/Alt.470mm  
 Cor: Branco / White  
 Difusor: Transp./Clear  
 Emb./Box Qt. 1pcs  
 P.U. 105,00€



**003.110GC.3GU10**

LED-3xGU10-Max.12W  
 Base: 220mm  
 Diam.142mm/Alt.470mm  
 Cor: Cinza/Grey  
 Difusor: Transp./Clear  
 Emb./Box Qt. 1pcs  
 P.U. 105,00€



**003.110BC.3GU10**

LED-3xGU10-Max. 12W  
 Base: 220mm  
 Diam.142mm/Alt.470mm  
 Cor: Preto/Black  
 Difusor: Transp./Clear  
 Emb./Box Qt. 1pcs  
 P.U. 105,00€



**003.110AC.3GU10**

LED-3xGU10-Max.12W  
 Base: 220mm  
 Diam.142mm/Alt.470mm  
 Cor: Antrac. /Dark Grey  
 Difusor: Transp./Clear  
 Emb./Box Qt. 1pcs  
 P.U. 107,00€

## Zeza 90° RD

Balizador Redondo 90° em Resina , Difusor PMMA  
 Round Bollard 90° Resin Material ,Diffuser PMMA



**003.140WO.E27**

E27 - Max. 18W  
 Base: 220mm  
 Diam.142mm/Alt.522mm  
 Cor: Branco / White  
 Difusor: Opalino/Opal  
 Emb./Box Qt. 1pcs  
 P.U. 91,00€



**003.140GO.E27**

E27 - Max. 18W  
 Base: 220mm  
 Diam.142mm/Alt.522mm  
 Cor: Cinza/Grey  
 Difusor: Opalino/Opal  
 Emb./Box Qt. 1pcs  
 P.U. 91,00€



**003.140BO.E27**

E27 - Max. 18W  
 Base: 220mm  
 Diam.142mm/Alt.522mm  
 Cor: Preto/Black  
 Difusor: Opalino/Opal  
 Emb./Box Qt. 1pcs  
 P.U. 91,00€



**003.140AO.E27**

E27 - Max. 18W  
 Base: 220mm  
 Diam.142mm/Alt.522mm  
 Cor: Antrac. /Dark Grey  
 Difusor: Opalino/Opal  
 Emb./Box Qt. 1pcs  
 P.U. 93,00€



**003.140WO.3GU10**

LED-3xGU10-Max.12W  
 Base: 220mm  
 Diam.142mm/Alt.522mm  
 Cor: Branco / White  
 Difusor: Opalino/Opal  
 Emb./Box Qt. 1pcs  
 P.U. 106,00€



**003.140GO.3GU10**

LED-3xGU10-Max.12W  
 Base: 220mm  
 Diam.142mm/Alt.522mm  
 Cor: Cinza/Grey  
 Difusor: Opalino/Opal  
 Emb./Box Qt. 1pcs  
 P.U. 106,00€



**003.140BO.3GU10**

LED-3xGU10-Max.12W  
 Base: 220mm  
 Diam.142mm/Alt.522mm  
 Cor: Preto/Black  
 Difusor: Opalino/Opal  
 Emb./Box Qt. 1pcs  
 P.U. 106,00€



**003.140AO.3GU10**

LED-3xGU10-Max.12W  
 Base: 220mm  
 Diam.142mm/Alt.522mm  
 Cor: Antrac. /Dark Grey  
 Difusor: Opalino/Opal  
 Emb./Box Qt. 1pcs  
 P.U. 108,00€



**003.140WC.3GU10**

LED-3xGU10-Max.12W  
 Base: 220mm  
 Diam.142mm/Alt.522mm  
 Cor: Branco / White  
 Difusor: Transp./Clear  
 Emb./Box Qt. 1pcs  
 P.U. 106,00€



**003.140GC.3GU10**

LED-3xGU10-Max.12W  
 Base: 220mm  
 Diam.142mm/Alt.522mm  
 Cor: Cinza/Grey  
 Difusor: Transp./Clear  
 Emb./Box Qt. 1pcs  
 P.U. 106,00€



**003.140BC.3GU10**

LED-3xGU10-Max.12W  
 Base: 220mm  
 Diam.142mm/Alt.522mm  
 Cor: Preto/Black  
 Difusor: Transp./Clear  
 Emb./Box Qt. 1pcs  
 P.U. 106,00€



**003.140AC.3GU10**

LED-3xGU10-Max.12W  
 Base: 220mm  
 Diam.142mm/Alt.522mm  
 Cor: Antrac. /Dark Grey  
 Difusor: Transp./Clear  
 Emb./Box Qt. 1pcs  
 P.U. 108,00€

## Zeza 800 RD

Balizador Redondo 770mm em Resina, Difusor PMMA, Max.20W  
Round Bollard 770mm Resin Material, Diffuser PMMA, Max.20W

VERSÃO LED / LED VERSION

VERSÃO E27 / E27 VERSION



(Não Incluídas)



(Não Incluída)



**003.120WO.E27**

E27 - Max. 18W  
Base: 220mm  
Diam.142mm/Alt.770mm  
Cor: Branco / White  
Difusor: Opalino/Opal  
Emb./Box Qt. 1pcs  
P.U. 98,00€



**003.120GO.E27**

E27 - Max. 18W  
Base: 220mm  
Diam.142mm/Alt.770mm  
Cor: Cinza/Grey  
Difusor: Opalino/Opal  
Emb./Box Qt. 1pcs  
P.U. 98,00€



**003.120BO.E27**

E27 - Max. 18W  
Base: 220mm  
Diam.142mm/Alt.770mm  
Cor: Preto/Black  
Difusor: Opalino/Opal  
Emb./Box Qt. 1pcs  
P.U. 98,00€



**003.120AO.E27**

E27 - Max. 18W  
Base: 220mm  
Diam.142mm/Alt.770mm  
Cor: Antrac. /Dark Grey  
Difusor: Opalino/Opal  
Emb./Box Qt. 1pcs  
P.U. 100,00€



**003.120WO.3GU10**

LED-3xGU10-Max.12W  
Base: 220mm  
Diam.142mm/Alt.770mm  
Cor: Branco / White  
Difusor: Opalino/Opal  
Emb./Box Qt. 1pcs  
P.U. 112,00€



**003.120GO.3GU10**

LED-3xGU10-Max.12W  
Base: 220mm  
Diam.142mm/Alt.770mm  
Cor: Cinza/Grey  
Difusor: Opalino/Opal  
Emb./Box Qt. 1pcs  
P.U. 112,00€



**003.120BO.3GU10**

LED-3xGU10-Max.12W  
Base: 220mm  
Diam.142mm/Alt.770mm  
Cor: Preto/Black  
Difusor: Opalino/Opal  
Emb./Box Qt. 1pcs  
P.U. 112,00€



**003.120AO.3GU10**

LED-3xGU10-Max.12W  
Base: 220mm  
Diam.142mm/Alt.770mm  
Cor: Antrac. /Dark Grey  
Difusor: Opalino/Opal  
Emb./Box Qt. 1pcs  
P.U. 114,00€



**003.120WC.3GU10**

LED-3xGU10-Max.12W  
Base: 220mm  
Diam.142mm/Alt.770mm  
Cor: Branco / White  
Difusor: Transp./Clear  
Emb./Box Qt. 1pcs  
P.U. 112,00€



**003.120GC.3GU10**

LED-3xGU10-Max.12W  
Base: 220mm  
Diam.142mm/Alt.770mm  
Cor: Cinza/Grey  
Difusor: Transp./Clear  
Emb./Box Qt. 1pcs  
P.U. 112,00€



**003.120BC.3GU10**

LED-3xGU10-Max.12W  
Base: 220mm  
Diam.142mm/Alt.770mm  
Cor: Preto/Black  
Difusor: Transp./Clear  
Emb./Box Qt. 1pcs  
P.U. 112,00€



**003.120AC.3GU10**

LED-3xGU10-Max.12W  
Base: 220mm  
Diam.142mm/Alt.770mm  
Cor: Antrac. /Dark Grey  
Difusor: Transp./Clear  
Emb./Box Qt. 1pcs  
P.U. 114,00€

## Zeza 1100 RD

Balizador Redondo 1070mm em Resina, Difusor PMMA  
Round Bollard 1070mm Resin Material, Diffuser PMMA



**003.130WO.E27**

E27 - Max. 18W  
Base: 220mm  
Diam142mm/Alt.1070mm  
Cor: Branco / White  
Difusor: Opalino/Opal  
Emb./Box Qt. 1pcs  
P.U. 110,00€



**003.130GO.E27**

E27 - Max. 18W  
Base: 220mm  
Diam142mm/Alt.1070mm  
Cor: Cinza/Grey  
Difusor: Opalino/Opal  
Emb./Box Qt. 1pcs  
P.U. 110,00€



**003.130BO.E27**

E27 - Max. 18W  
Base: 220mm  
Diam142mm/Alt.1070mm  
Cor: Preto/Black  
Difusor: Opalino/Opal  
Emb./Box Qt. 1pcs  
P.U. 110,00€



**003.130AO.E27**

E27 - Max. 18W  
Base: 220mm  
Diam142mm/Alt.1070mm  
Cor: Antrac./Dark Grey  
Difusor: Opalino/Opal  
Emb./Box Qt. 1pcs  
P.U. 114,00€



**003.130WO.3GU10**

LED-3xGU10-Max.12W  
Base: 220mm  
Diam142mm/Alt.1070mm  
Cor: Branco / White  
Difusor: Opalino/Opal  
Emb./Box Qt. 1pcs  
P.U. 125,00€



**003.130GO.3GU10**

LED-3xGU10-Max.12W  
Base: 220mm  
Diam142mm/Alt.1070mm  
Cor: Cinza/Grey  
Difusor: Opalino/Opal  
Emb./Box Qt. 1pcs  
P.U. 125,00€



**003.130BO.3GU10**

LED-3xGU10-Max.12W  
Base: 220mm  
Diam142mm/Alt.1070mm  
Cor: Preto/Black  
Difusor: Opalino/Opal  
Emb./Box Qt. 1pcs  
P.U. 125,00€



**003.130AO.3GU10**

LED-3xGU10-Max.12W  
Base: 220mm  
Diam142mm/Alt.1070mm  
Cor: Antrac. /Dark Grey  
Difusor: Opalino/Opal  
Emb./Box Qt. 1pcs  
P.U. 125,00€



**003.130WC.3GU10**

LED-3xGU10-Max.12W  
Base: 220mm  
Diam142mm/Alt.1070mm  
Cor: Branco / White  
Difusor: Transp./Clear  
Emb./Box Qt. 1pcs  
P.U. 125,00€



**003.130GC.3GU10**

LED-3xGU10-Max.12W  
Base: 220mm  
Diam142mm/Alt.1070mm  
Cor: Cinza/Grey  
Difusor: Transp./Clear  
Emb./Box Qt. 1pcs  
P.U. 125,00€

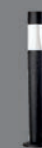

**003.130BC.3GU10**

LED-3xGU10-Max.12W  
Base: 220mm  
Diam142mm/Alt.1070mm  
Cor: Preto/Black  
Difusor: Transp./Clear  
Emb./Box Qt. 1pcs  
P.U. 125,00€



**003.130AC.3GU10**

LED-3xGU10-Max.12W  
Base: 220mm  
Diam142mm/Alt.1070mm  
Cor: Antrac. /Dark Grey  
Difusor: Transp./Clear  
Emb./Box Qt. 1pcs  
P.U. 128,00€



# Balizadores Quadrados

## ZEZA-SQ

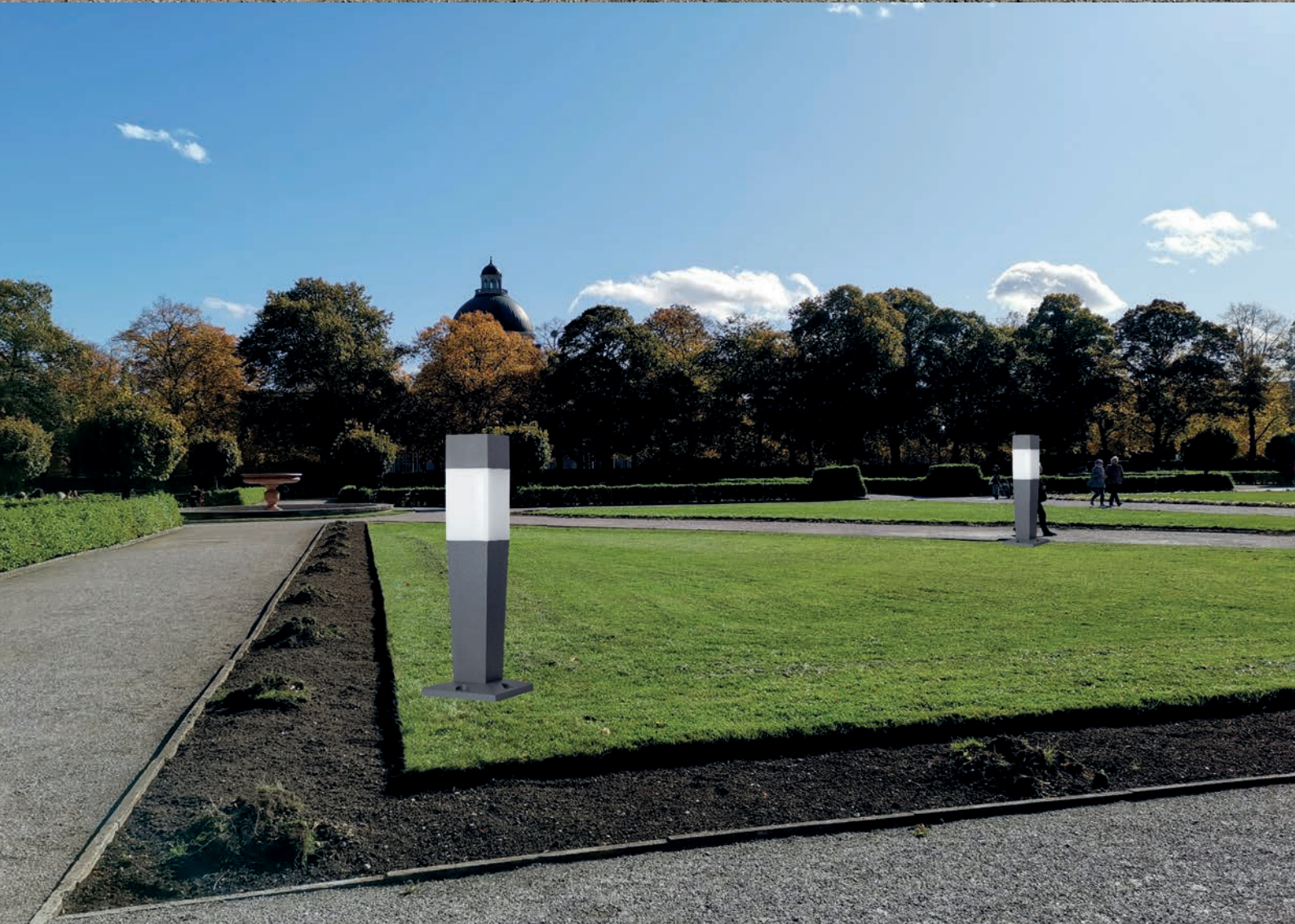

## Zeza 500 SQ

Balizador Quadrado 770mm em Resina, Difusor PMMA, Max.20W  
Square Bollard 770mm Resin Material, Diffuser PMMA, Max.20W

VERSÃO LED / LED VERSION

VERSÃO E27 / E27 VERSION



(Não Incluídas)



(Não Incluída)



**003.010WO.E27**

E27 - Max. 18W  
Base: 220mm  
Diam. 142mm/Alt. 470mm  
Cor: Branco / White  
Difusor: Opalino/Opal  
Emb./Box Qt. 1pcs  
P.U. 90,00€



**003.010GO.E27**

E27 - Max. 18W  
Base: 220mm  
Diam. 142mm/Alt. 470mm  
Cor: Cinza/Grey  
Difusor: Opalino/Opal  
Emb./Box Qt. 1pcs  
P.U. 90,00€



**003.010BO.E27**

E27 - Max. 18W  
Base: 220mm  
Diam. 142mm/Alt. 470mm  
Cor: Preto/Black  
Difusor: Opalino/Opal  
Emb./Box Qt. 1pcs  
P.U. 90,00€



**003.010AO.E27**

E27 - Max. 18W  
Base: 220mm  
Diam. 142mm/Alt. 470mm  
Cor: Antrac. /Dark Grey  
Difusor: Opalino/Opal  
Emb./Box Qt. 1pcs  
P.U. 92,00€



**003.010WO.4GU10**

4xGU10-Max. 12W  
Base: 220mm  
Diam. 142mm/Alt. 470mm  
Cor: Branco / White  
Difusor: Opalino/Opal  
Emb./Box Qt. 1pcs  
P.U. 105,00€



**003.010GO.4GU10**

4xGU10-Max. 12W  
Base: 220mm  
Diam. 142mm/Alt. 470mm  
Cor: Cinza/Grey  
Difusor: Opalino/Opal  
Emb./Box Qt. 1pcs  
P.U. 105,00€



**003.010BO.4GU10**

4xGU10-Max. 12W  
Base: 220mm  
Diam. 142mm/Alt. 470mm  
Cor: Preto/Black  
Difusor: Opalino/Opal  
Emb./Box Qt. 1pcs  
P.U. 105,00€



**003.010AO.4GU10**

4xGU10-Max. 12W  
Base: 220mm  
Diam. 142mm/Alt. 470mm  
Cor: Antrac. /Dark Grey  
Difusor: Opalino/Opal  
Emb./Box Qt. 1pcs  
P.U. 108,00€

## Zeza 90° SQ

Balizador Quadrado 90° em Resina, Difusor PMMA  
Square Bollard 90° Resin Material, Diffuser PMMA



**003.040WO.E27**

E27 - Max. 18W  
Base: 220mm  
Diam. 142mm/Alt. 522mm  
Cor: Branco / White  
Difusor: Opalino/Opal  
Emb./Box Qt. 1pcs  
P.U. 91,00€



**003.040GO.E27**

E27 - Max. 18W  
Base: 220mm  
Diam. 142mm/Alt. 522mm  
Cor: Cinza/Grey  
Difusor: Opalino/Opal  
Emb./Box Qt. 1pcs  
P.U. 91,00€



**003.040BO.E27**

E27 - Max. 18W  
Base: 220mm  
Diam. 142mm/Alt. 522mm  
Cor: Preto/Black  
Difusor: Opalino/Opal  
Emb./Box Qt. 1pcs  
P.U. 91,00€



**003.040AO.E27**

E27 - Max. 18W  
Base: 220mm  
Diam. 142mm/Alt. 522mm  
Cor: Antrac. /Dark Grey  
Difusor: Opalino/Opal  
Emb./Box Qt. 1pcs  
P.U. 93,00€



**003.040WO.4GU10**

4xGU10-Max. 12W  
Base: 220mm  
Diam. 142mm/Alt. 522mm  
Cor: Branco / White  
Difusor: Opalino/Opal  
Emb./Box Qt. 1pcs  
P.U. 106,00€



**003.040GO.4GU10**

4xGU10-Max. 12W  
Base: 220mm  
Diam. 142mm/Alt. 522mm  
Cor: Cinza/Grey  
Difusor: Opalino/Opal  
Emb./Box Qt. 1pcs  
P.U. 106,00€



**003.040BO.4GU10**

4xGU10-Max. 12W  
Base: 220mm  
Diam. 142mm/Alt. 522mm  
Cor: Preto/Black  
Difusor: Opalino/Opal  
Emb./Box Qt. 1pcs  
P.U. 106,00€



**003.040AO.4GU10**

4xGU10-Max. 12W  
Base: 220mm  
Diam. 142mm/Alt. 522mm  
Cor: Antrac. /Dark Grey  
Difusor: Opalino/Opal  
Emb./Box Qt. 1pcs  
P.U. 108,00€

## Zeza 800 SQ

Balizador Quadrado 770mm em Resina, Difusor PMMA, Max. 20W  
Square Bollard 770mm Resin Material, Diffuser PMMA, Max.20W

VERSÃO LED / LED VERSION

VERSÃO E27 / E27 VERSION



**003.020WO.E27**

E27 - Max. 18W  
Base: 250mm  
Diam.142mm/Alt.770mm  
Cor: Branco / White  
Difusor: Opalino/Opal  
Emb./Box Qt. 1pcs  
P.U. 98,00€



**003.020GO.E27**

E27 - Max. 18W  
Base: 250mm  
Diam.142mm/Alt.770mm  
Cor: Cinza/Grey  
Difusor: Opalino/Opal  
Emb./Box Qt. 1pcs  
P.U. 98,00€



**003.020BO.E27**

E27 - Max. 18W  
Base: 250mm  
Diam.142mm/Alt.770mm  
Cor: Preto/Black  
Difusor: Opalino/Opal  
Emb./Box Qt. 1pcs  
P.U. 98,00€



**003.020AO.E27**

E27 - Max. 18W  
Base: 250mm  
Diam.142mm/Alt.770mm  
Cor: Antrac. /Dark Grey  
Difusor: Opalino/Opal  
Emb./Box Qt. 1pcs  
P.U. 101,00€



**003.020WO.4GU10**

LED-4xGU10-Max.12W  
Base: 250mm  
Diam.142mm/Alt.770mm  
Cor: Branco / White  
Difusor: Opalino/Opal  
Emb./Box Qt. 1pcs  
P.U. 112,00€



**003.020GO.4GU10**

LED-4xGU10-Max.12W  
Base: 250mm  
Diam.142mm/Alt.770mm  
Cor: Cinza/Grey  
Difusor: Opalino/Opal  
Emb./Box Qt. 1pcs  
P.U. 112,00€



**003.020BO.4GU10**

LED-4xGU10-Max.12W  
Base: 250mm  
Diam.142mm/Alt.770mm  
Cor: Preto/Black  
Difusor: Opalino/Opal  
Emb./Box Qt. 1pcs  
P.U. 112,00€



**003.020AO.4GU10**

LED-4xGU10-Max.12W  
Base: 250mm  
Diam.142mm/Alt.770mm  
Cor: Antrac. /Dark Grey  
Difusor: Opalino/Opal  
Emb./Box Qt. 1pcs  
P.U. 114,00€

## Zeza 1100 SQ

Balizador Quadrado 1070mm em Resina, Difusor PMMA  
Square Bollard 1070mm Resin Material, Diffuser PMMA



**003.030WO.E27**

E27 - Max. 18W  
Base: 250mm  
Diam142mm/Alt.1070mm  
Cor: Branco / White  
Difusor: Opalino/Opal  
Emb./Box Qt. 1pcs  
P.U. 110,00€



**003.030GO.E27**

E27 - Max. 18W  
Base: 250mm  
Diam142mm/Alt.1070mm  
Cor: Cinza/Grey  
Difusor: Opalino/Opal  
Emb./Box Qt. 1pcs  
P.U. 110,00€



**003.030BO.E27**

E27 - Max. 18W  
Base: 250mm  
Diam142mm/Alt.1070mm  
Cor: Preto/Black  
Difusor: Opalino/Opal  
Emb./Box Qt. 1pcs  
P.U. 110,00€



**003.030AO.E27**

E27 - Max. 18W  
Base: 250mm  
Diam142mm/Alt.1070mm  
Cor: Antrac. /Dark Grey  
Difusor: Opalino/Opal  
Emb./Box Qt. 1pcs  
P.U. 113,00€



**003.030WO.4GU10**

LED-4xGU10-Max.12W  
Base: 250mm  
Diam142mm/Alt.1070mm  
Cor: Branco / White  
Difusor: Opalino/Opal  
Emb./Box Qt. 1pcs  
P.U. 125,00€



**003.030GO.4GU10**

LED-4xGU10-Max.12W  
Base: 250mm  
Diam142mm/Alt.1070mm  
Cor: Cinza/Grey  
Difusor: Opalino/Opal  
Emb./Box Qt. 1pcs  
P.U. 125,00€



**003.030BO.4GU10**

LED-4xGU10-Max.12W  
Base: 250mm  
Diam142mm/Alt.1070mm  
Cor: Preto/Black  
Difusor: Opalino/Opal  
Emb./Box Qt. 1pcs  
P.U. 125,00€



**003.030AO.4GU10**

LED-4xGU10-Max.12W  
Base: 250mm  
Diam142mm/Alt.1070mm  
Cor: Antrac. /Dark Grey  
Difusor: Opalino/Opal  
Emb./Box Qt. 1pcs  
P.U. 128,00€

# México

# soflight®



Led: **OSRAM**

Driver: **AMV** ou / or **TRIDONIC**

Placa Led 50 000 Horas; 5 Anos Garantia

Led PCB 50 000 Hours; 5 Years Warranty

Campânula Led em Resina  
LED High Bay Resin Material

# MÉXICO

Opção Casambi e Dalli por Encomenda

# CASAMBI

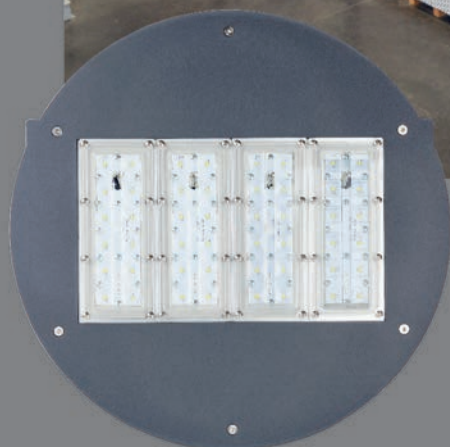

Led: **OSRAM**

Driver: **AMV** ou / or **TRIDONIC**

Placa Led 50 000 Horas; 5 Anos Garantia

Led PCB 50 000 Hours; 5 Years Warranty

## Opção Casambi e Dalli por Encomenda

# CASAMBI



México-HB

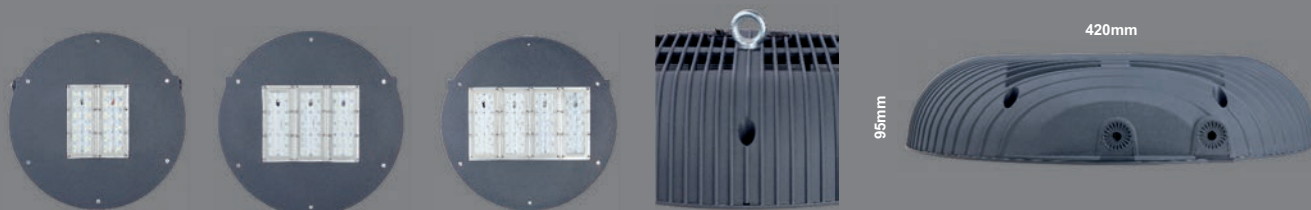

### Campânula Led em Resina 120° / Led High Bay Resin Material

006.010.AC.050.54 Campanula / High Bay Led 40W 5 200lm 5700K em Resina / Resin Body	P.U. 147,00€
006.010.AC.050.84 Campanula / High Bay Led 40W 5 000lm 4000K em Resina / Resin Body	P.U. 147,00€
006.010.AC.100.54 Campanula / High Bay Led 80W 10 400lm 5700K em Resina / Resin Body	P.U. 182,00€
006.010.AC.100.84 Campanula / High Bay Led 80W 10 000lm 4000K em Resina / Resin Body	P.U. 182,00€
006.010.AC.150.54 Campanula / High Bay Led 120W 15 600lm 5700K em Resina / Resin Body	P.U. 216,00€
006.010.AC.150.84 Campanula / High Bay Led 120W 15 000lm 4000K em Resina / Resin Body	P.U. 216,00€
006.010.AC.200.54 Campanula / High Bay Led 160W 20 800lm 5700K em Resina / Resin Body	P.U. 287,00€
006.010.AC.200.84 Campanula / High Bay Led 160W 20 000lm 4000K em Resina / Resin Body	P.U. 287,00€

### Campânula Led em Resina 90° / Led High Bay Resin Material

006.015.AC.050.54 Campanula / High Bay Led 40W 5 200lm 5700K em Resina / Resin Body	P.U. 147,00€
006.015.AC.050.84 Campanula / High Bay Led 40W 5 000lm 4000K em Resina / Resin Body	P.U. 147,00€
006.015.AC.100.54 Campanula / High Bay Led 80W 10 400lm 5700K em Resina / Resin Body	P.U. 182,00€
006.015.AC.100.84 Campanula / High Bay Led 80W 10 000lm 4000K em Resina / Resin Body	P.U. 182,00€
006.015.AC.150.54 Campanula / High Bay Led 120W 15 600lm 5700K em Resina / Resin Body	P.U. 216,00€
006.015.AC.150.84 Campanula / High Bay Led 120W 15 000lm 4000K em Resina / Resin Body	P.U. 216,00€
006.015.AC.200.54 Campanula / High Bay Led 160W 20 800lm 5700K em Resina / Resin Body	P.U. 287,00€
006.015.AC.200.84 Campanula / High Bay Led 160W 20 000lm 4000K em Resina / Resin Body	P.U. 287,00€

### Campânula Led em Resina 60° / Led High Bay Resin Material

006.020.AC.050.54 Campanula / High Bay Led 40W 5 200lm 5700K em Resina / Resin Body	P.U. 147,00€
006.020.AC.050.84 Campanula / High Bay Led 40W 5 000lm 4000K em Resina / Resin Body	P.U. 147,00€
006.020.AC.100.54 Campanula / High Bay Led 80W 10 400lm 5700K em Resina / Resin Body	P.U. 182,00€
006.020.AC.100.84 Campanula / High Bay Led 80W 10 000lm 4000K em Resina / Resin Body	P.U. 182,00€
006.020.AC.150.54 Campanula / High Bay Led 120W 15 600lm 5700K em Resina / Resin Body	P.U. 216,00€
006.020.AC.150.84 Campanula / High Bay Led 120W 15 000lm 4000K em Resina / Resin Body	P.U. 216,00€
006.020.AC.200.54 Campanula / High Bay Led 160W 20 800lm 5700K em Resina / Resin Body	P.U. 287,00€
006.020.AC.200.84 Campanula / High Bay Led 160W 20 000lm 4000K em Resina / Resin Body	P.U. 287,00€

AC Input Voltage Range:	180-295Vac
Corrent Adjustment Range:	50% ~100%
Over Voltage Protection:	105% ~145%
Over Current Protection	95% ~108% Constant Current Limiting, Auto-Recovery
Over Temperature Protection:	Shut Down O/P Voltage, re-power on to recover
Working Temperature:	-20 ~ + 45°
Protections:	Short Circuit / Over Voltage / Over Temperature / IP65
ECO Design:	No Load Power Consumption < 0,5W
High Efficiency:	98%

#### Opções por Encomenda / Options:

- \* DALI
- \* Dimming: 0-10Vdc, PWM signal, or Resistance
- \* Smart Timming Dimming Function
- \* Lux Control

Devido à constante evolução deste tipo de produtos a marca dos Leds e Drivers assim como as características técnicas podem ser alterados sem aviso prévio, por favor consultar o folheto ou solicite a ficha técnica atualizada dos artigos pretendidos

Obs: Não Ligar com Sensores  
Working Temperature -20 + 45°  
Temperatura Funcionamento -20 + 45°



Led: **OSRAM**

Driver: **AMW** ou / or **TRIDONIC**

Placa Led 50 000 Horas; 5 Anos Garantia

Led PCB 50 000 Hours; 5 Years Warranty

Opção Casambi e Dali por Encomenda

**CASAMBI**



México - FL

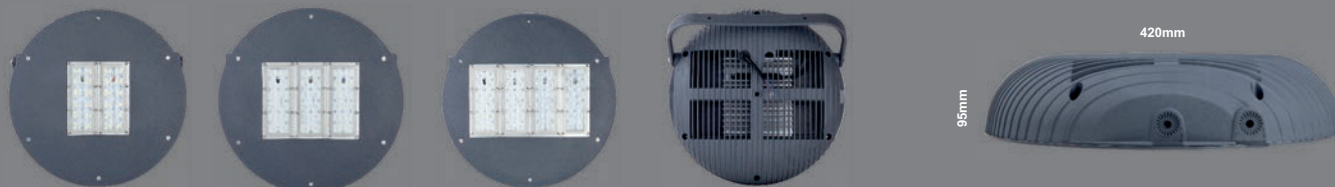

**Projektor Led em Resina 120° / Floodlight Resin Material**

006.045.AC.050.54	Projektor / Floodlight Led 40W 5 200lm 5700K em Resina / Resin Body	P.U. 151,00€
006.045.AC.050.84	Projektor / Floodlight Led 40W 5 000lm 4000K em Resina / Resin Body	P.U. 151,00€
006.045.AC.100.54	Projektor / Floodlight Led 80W 10 400lm 5700K em Resina / Resin Body	P.U. 187,00€
006.045.AC.100.84	Projektor / Floodlight Led 80W 10 000lm 4000K em Resina / Resin Body	P.U. 187,00€
006.045.AC.150.54	Projektor / Floodlight Led 120W 15 600lm 5700K em Resina / Resin Body	P.U. 220,00€
006.045.AC.150.84	Projektor / Floodlight Led 120W 15 000lm 4000K em Resina / Resin Body	P.U. 220,00€
006.045.AC.200.54	Projektor / Floodlight Led 160W 20 800lm 5700K em Resina / Resin Body	P.U. 291,00€
006.045.AC.200.84	Projektor / Floodlight Led 160W 20 000lm 4000K em Resina / Resin Body	P.U. 291,00€

**Projektor Led em Resina 90° / Floodlight Resin Material**

006.050.AC.050.54	Projektor / Floodlight Led 40W 5 200lm 5700K em Resina / Resin Body	P.U. 151,00€
006.050.AC.050.84	Projektor / Floodlight Led 40W 5 000lm 4000K em Resina / Resin Body	P.U. 151,00€
006.050.AC.100.54	Projektor / Floodlight Led 80W 10 400lm 5700K em Resina / Resin Body	P.U. 187,00€
006.050.AC.100.84	Projektor / Floodlight Led 80W 10 000lm 4000K em Resina / Resin Body	P.U. 187,00€
006.050.AC.150.54	Projektor / Floodlight Led 120W 15 600lm 5700K em Resina / Resin Body	P.U. 220,00€
006.050.AC.150.84	Projektor / Floodlight Led 120W 15 000lm 4000K em Resina / Resin Body	P.U. 220,00€
006.050.AC.200.54	Projektor / Floodlight Led 160W 20 800lm 5700K em Resina / Resin Body	P.U. 291,00€
006.050.AC.200.84	Projektor / Floodlight Led 160W 20 000lm 4000K em Resina / Resin Body	P.U. 291,00€

**Projektor Led em Resina 60° / Floodlight Resin Material**

006.055.AC.050.54	Projektor / Floodlight Led 40W 5 200lm 5700K em Resina / Resin Body	P.U. 151,00€
006.055.AC.050.84	Projektor / Floodlight Led 40W 5 000lm 4000K em Resina / Resin Body	P.U. 151,00€
006.055.AC.100.54	Projektor / Floodlight Led 80W 10 400lm 5700K em Resina / Resin Body	P.U. 187,00€
006.055.AC.100.84	Projektor / Floodlight Led 80W 10 000lm 4000K em Resina / Resin Body	P.U. 187,00€
006.055.AC.150.54	Projektor / Floodlight Led 120W 15 600lm 5700K em Resina / Resin Body	P.U. 220,00€
006.055.AC.150.84	Projektor / Floodlight Led 120W 15 000lm 4000K em Resina / Resin Body	P.U. 220,00€
006.055.AC.200.54	Projektor / Floodlight Led 160W 20 800lm 5700K em Resina / Resin Body	P.U. 291,00€
006.055.AC.200.84	Projektor / Floodlight Led 160W 20 000lm 4000K em Resina / Resin Body	P.U. 291,00€

**Projektor Led Resina Assimétrico / Floodlight Resin Material**

006.060.AC.050.54	Projektor / Floodlight Led 40W 5 200lm 5700K em Resina / Resin Body	P.U. 151,00€
006.060.AC.050.84	Projektor / Floodlight Led 40W 5 000lm 4000K em Resina / Resin Body	P.U. 151,00€
006.060.AC.100.54	Projektor / Floodlight Led 80W 10 400lm 5700K em Resina / Resin Body	P.U. 187,00€
006.060.AC.100.84	Projektor / Floodlight Led 80W 10 000lm 4000K em Resina / Resin Body	P.U. 187,00€
006.060.AC.150.54	Projektor / Floodlight Led 120W 15 600lm 5700K em Resina / Resin Body	P.U. 220,00€
006.060.AC.150.84	Projektor / Floodlight Led 120W 15 000lm 4000K em Resina / Resin Body	P.U. 220,00€
006.060.AC.200.54	Projektor / Floodlight Led 160W 20 800lm 5700K em Resina / Resin Body	P.U. 291,00€
006.060.AC.200.84	Projektor / Floodlight Led 160W 20 000lm 4000K em Resina / Resin Body	P.U. 291,00€

AC Input Voltage Range:	180-295Vac
Corrent Adjustment Range:	50% ~100%
Over Voltage Protection:	105% ~145%
Over Current Protection	95% ~108% Constant Current Limiting, Auto-Recovery
Over Temperature Protection:	Shut Down O/P Voltage, re-power on to recover
Working Temperature:	-20 ~ + 45°
Protections:	Short Circuit / Over Voltage / Over Temperature / IP65
ECO Design:	No Load Power Consumption < 0,5W
High Efficiency:	98%

**Opções por Encomenda / Options:**

- \* DALI
- \* Dimming: 0-10Vdc, PWM signal, or Resistance
- \* Smart Timming Dimming Function
- \* Lux Control

Devido à constante evolução deste tipo de produtos a marca dos Leds e Drivers assim como as características técnicas podem ser alterados sem aviso prévio, por favor consultar o folheto ou solicite a ficha técnica atualizada dos artigos pretendidos

Obs: Não Ligar com Sensores  
Working Temperature -20 + 45°  
Temperatura Funcionamento -20 + 45°

Armadura Estanque Led com Difusor Opalino em PC  
Waterproof Lighting Opal Diffuser PC

Led: **OSRAM**

Placa Led 50 000 Horas; 5 Anos Garantia  
Led PCB 50 000 Hours; 5 Years Warranty

Opção Casambi e Dalli por Encomenda

## CASAMBI



### Lisboa

#### Armadura Estanque Led IP 65 ( Barra com 1 linha Led ) Waterproof Lighting Led IP 65 ( Pcb with 1 Led Line )

- 008.010.GO.010.54 Arm. Est. Led 0,60mt / Led Waterp.6000K 12W 1620lm
- 008.010.GO.010.84 Arm. Est. Led 0,60mt / Led Waterp.4000K 12W 1440m
- 008.010.GO.020.54 Arm. Est. Led 1,20mt / Led Waterp.6000K 25W 3240lm
- 008.010.GO.020.84 Arm. Est. Led 1,20mt / Led Waterp.4000K 25W 2880lm
- 008.010.GO.030.54 Arm. Est. Led 1,50mt / Led Waterp.6000K 30W 4050lm
- 008.010.GO.030.84 Arm. Est. Led 1,50mt / Led Waterp.4000K 30W 3600lm



Electrificado com barra Led ( Osram ) Dupla ( 2 Linhas )  
Assembled with Osram Led ( 2 Led Line )



- P.U. 56,00€
- P.U. 56,00€
- P.U. 89,00€
- P.U. 89,00€
- P.U. 133,50€
- P.U. 133,50€

#### Armadura Estanque Led IP 65 ( Barra com 2 linhas Led ) Waterproof Lighting Led IP 65 ( Pcb with 2 Led Lines )

- 008.020.GO.010.54 Arm. Est. Led 0,60mt / Led Waterp.6000K 24W 3240lm
- 008.020.GO.010.84 Arm. Est. Led 0,60mt / Led Waterp.4000K 24W 2880lm
- 008.020.GO.020.54 Arm. Est. Led 1,20mt / Led Waterp. 6000K 50W 6480lm
- 008.020.GO.020.84 Arm. Est. Led 1,20mt / Led Waterp. 4000K 50W 5760lm
- 008.020.GO.030.54 Arm. Est. Led 1,50mt / Led Waterp. 6000K 60W 8100lm
- 008.020.GO.030.84 Arm. Est. Led 1,50mt / Led Waterp. 4000K 60W 7200lm



Electrificado com barra Led ( Osram ) Simples ( Linha )  
Assembled with Osram Led ( 1 Led Line )



- P.U. 75,00€
- P.U. 75,00€
- P.U. 150,00€
- P.U. 150,00€
- P.U. 190,00€
- P.U. 190,00€

### Rafa

Campânula Industrial em Resina  
Resin High Bay

### Rafa



**005.010.B0.E27**

E27 Vazia - Max. 400W  
Antracite/Dark Grey  
Emb./Box Qt. 2pcs  
P.U. 35,00€



**005.010.B0.E40**

E40 Vazia - Max. 400W  
Antracite/Dark Grey  
Emb./Box Qt. 2pcs  
P.U. 35,00€



**005.040.A0.000**

Refletor Alumínio Liso  
Aluminium Reflector  
Diam.: 480mm  
P.U. 22,00€



**005.050.A0.000**

Refletor Alum. Canelado  
Aluminium Reflector  
Diam.: 480mm  
P.U. 22,00€



**005.060.CC.000**

Vidro Temperado  
Clear Tempered Glass  
Diam.: 480mm  
P.U. 15,50€





Caixas de Aparelhagem para Paredes Ocas, Ensaio Fio Incandescente: 650°  
Flush Mounting Junction Boxes, Glow Wire 650°

**HF** Halogen FREE



**230.400.000.GG**

Caixa Pladur Quadrupla  
Mounting Aid, Cavity Wall systems  
IP 20  
Cinza / Grey: Ral 7035  
Comprimento 400mm  
Largura: 93mm  
Altura: 62mm  
Emb./Box Qt.: 50 pcs  
**P.U. 8,00€**

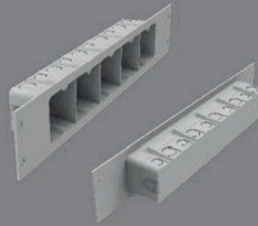

**230.500.000.GG**

Caixa Pladur Quintupla  
Mounting Aid, Cavity Wall systems  
IP 20  
Cinza / Grey: Ral 7035  
Comprimento 500mm  
Largura: 93mm  
Altura: 62mm  
Emb./Box Qt.: 50 pcs  
**P.U. 8,50€**

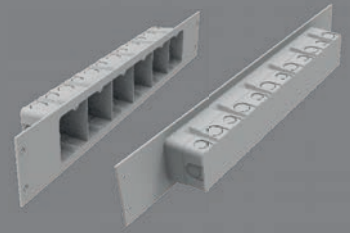

**230.600.000.GG**

Caixa Pladur Sextupla  
Mounting Aid, Cavity Wall systems  
IP 20  
Cinza / Grey: Ral 7035  
Comprimento 600mm  
Largura: 93mm  
Altura: 62mm  
Emb./Box Qt.: 50 pcs  
**P.U. 9,00€**



**220.045.040.000.GG**

Caixa Aplique  
M.Aid, Cavity Wall systems  
IP 20  
Cinza / Grey: Ral 7035  
Diam.: 45mm  
Altura: 40mm  
Emb./Box Qt.: 50 pcs  
**P.U. 0,99€**



**220.070.040.000.GG**

Caixa Aparelhagem Baixa  
M. Aid, Cavity Wall systems  
IP 20  
Cinza / Grey: Ral 7035  
Diam.: 70mm  
Altura: 40mm  
Emb./Box Qt.: 100 pcs  
**P.U. 1,05€**



**220.070.060.000.GG**

Caixa Aparelhagem Funda  
M.Aid, Cavity Wall systems  
IP 20  
Cinza / Grey: Ral 7035  
Diam.: 70mm  
Altura: 60mm  
Emb./Box Qt. 50 pcs  
**P.U. 1,10€**



**220.070.040.002.GG**

Caixa Aparelhagem Dupla  
M.Aid, Cavity Wall systems  
IP 20  
Cinza / Grey: Ral 7035  
Diam.: 70mm  
Altura: 50mm  
Emb./Box Qt.: 28 pcs  
**P.U. 2,20€**



**220.070.040.003.GG**

Caixa Aparelhagem Tripla  
M.Aid, Cavity Wall systems  
IP 20  
Cinza / Grey: Ral 7035  
Diam.: 70mm  
Altura: 50mm  
Emb./Box Qt. 16 pcs  
**P.U. 3,30€**



**220.115.045.000.GG**

Caixa Quadrada c/Tampa  
M.Aid, Cavity Wall systems  
IP 20  
Cinza / Grey: Ral 7035  
Diam.: 115x115mm  
Altura: 45mm  
Emb./Box Qt.: 36 pcs  
**P.U. 3,50€**



**220.045.TMP.WH**

Tampa p/ Caixa Aplique  
M.Aid, Cavity Wall systems  
IP 20  
Cor: Branca / White  
Diam.: 55mm



**220.070.001.TMP.WH**

Tampa p/Caixa Aparelhagem  
M.Aid, Cavity Wall systems  
IP 20  
Cor: Branca / White  
Diam.: 82mm



**220.070.002.TMP.WH**

T.dupla p/Caixa Aparelhagem  
M. Aid, Cavity Wall systems  
IP 20  
Cor: Branca / White  
Altura: 78mm  
Comprimento: 160mm



**220.070.003.TMP.WH**

T.Tripla p/Caixa Aparelhagem  
M. Aid, Cavity Wall systems  
IP 20  
Cor: Branca / White  
Altura: 78mm  
Comprimento: 235mm



**225.041.035.000.PP**

Caixa Aplique  
IP 20  
Cor: Branca / White  
Dimensões: 41x35mm  
Embalagem: 50Unid.  
**P.U. 0,13€**



**225.070.040.000.PP**

Caixa Aparelhagem Baixa  
Mounting Aid, Cavity Wall systems  
IP 20  
Cor: Branca / White  
Dimensões: 70x40mm  
Embalagem: 10Unid.  
**P.U. 0,19€**



**225.070.060.000.PP**

Caixa Aparelhagem Funda  
Mounting Aid, Cavity Wall systems  
IP 20  
Cor: Branca / White  
Dimensões: 70x60mm  
Embalagem: 10Unid.  
**P.U. 0,25€**



**225.090.090.040.PP**

Caixa Derivação Quadrada com Tampa  
Mounting Aid, Cavity Wall systems  
IP 20  
Cor: Branca / White  
Dimensões: 90x90x40mm  
Embalagem: 10Unid.  
**P.U. 0,50€**



Caixa Derivação IP 65 / IP 66- Ensaio Fio Incandescente 650°  
Junction Box IP 65/ IP 66 - Glow Wire 650°

**HF** Halogen FREE

## Caixas B...

Quantidade Mínima 96 Unid.

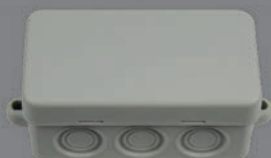

**200.080.044.035.GG**

Modelo: B044  
Caixa Derivação IP 65  
Junction Box IP 65  
Cinza / Grey: Ral 7035  
80x44x35mm  
Emb./Box Qt. 96pcs  
P.U. 0,92€



**200.200.150.080.GG**

Modelo B200  
Caixa Derivação IP 66  
Junction Box IP 66  
Cinza / Grey: Ral 7035  
200x150x80mm  
Emb./Box Qt. 12pcs  
P.U. 5,90€



**200.250.200.140.GT**

Modelo B250  
Caixa Derivação IP 66  
Junction Box IP 66  
Cinza / Grey: Ral 7035  
250x200x140mm  
Emb./Box Qt. 1pcs  
P.U. 17,00€

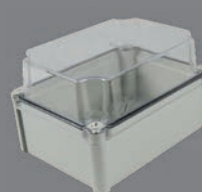

**201.200.150.125.GT**

Modelo B250  
Caixa Derivação IP 66  
Junction Box IP 66  
Cinza / Grey: Ral 7035  
200x150x125mm  
Emb./Box Qt. 1pcs  
P.U. 10,50€



**200.200.150.125.GM**

Caixa Guarda Motor  
Caixa Derivação IP 66  
Junction Box IP 66  
Cinza / Grey: Ral 7035  
200x150x125mm  
Emb./Box Qt. 1pcs  
P.U. 17,00€

Quantidade Mínima 168 Unid.

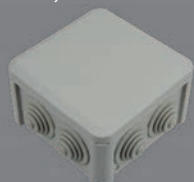

**200.090.090.053.GG**

Modelo: B090  
Caixa Derivação IP 65  
Junction Box IP 65  
Cinza / Grey: Ral 7035  
90x90x53mm  
Emb./Box Qt. 168pcs  
P.U. 1,50€



**200.200.150.125.GG**

Modelo B200  
Caixa Derivação IP 66  
Junction Box IP 66  
Cinza / Grey: Ral 7035  
200x150x125mm  
Emb./Box Qt. 12pcs  
P.U. 7,60€

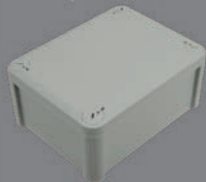

**201.150.115.070.GG**

Modelo B150  
Caixa Derivação IP 66  
Junction Box IP 66  
Cinza / Grey: Ral 7035  
150x115x70mm  
Emb./Box Qt. 12pcs  
P.U. 4,00€



**201.250.200.140.GG**

Modelo B250  
Caixa Derivação IP 66  
Junction Box IP 66  
Cinza / Grey: Ral 7035  
250x200x140mm  
Emb./Box Qt. 1pcs  
P.U. 9,70€

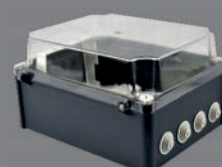

**200.250.200.140.QS**

Caixa para Quadro Sondas  
Caixa Derivação IP 66  
Junction Box IP 66  
Antracite / Dark  
250x200x140mm  
Emb./Box Qt. 1pcs  
P.U. 18,00€

Quantidade Mínima 36 Unid.



**200.115.115.060.GG**

Modelo: B115  
Caixa Derivação IP 66  
Junction Box IP 66  
Cinza / Grey: Ral 7035  
115x115x60mm  
Emb./Box Qt. 36pcs  
P.U. 2,20€



**200.200.150.125.GT**

Modelo B200  
Caixa Derivação IP 66  
Junction Box IP 66  
Cinza / Grey: Ral 7035  
200x150x125mm  
Emb./Box Qt. 1pcs  
P.U. 11,00€



**201.200.150.080.GG**

Modelo B200  
Caixa Derivação IP 66  
Junction Box IP 66  
Cinza / Grey: Ral 7035  
200x150x80mm  
Emb./Box Qt. 1pcs  
P.U. 5,80€

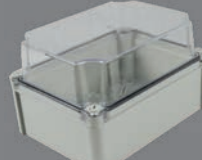

**201.250.200.140.GT**

Modelo B250  
Caixa Derivação IP 66  
Junction Box IP 66  
Cinza / Grey: Ral 7035  
250x200x140mm  
Emb./Box Qt. 1pcs  
P.U. 16,00€

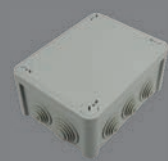

**200.150.115.070.GG**

Modelo B150  
Caixa Derivação IP 66  
Junction Box IP 66  
Cinza / Grey: Ral 7035  
150x115x70mm  
Emb./Box Qt. 12pcs  
P.U. 4,10€



**200.250.200.140.GG**

Modelo B250  
Caixa Derivação IP 66  
Junction Box IP 66  
Cinza / Grey: Ral 7035  
250x200x140mm  
Emb./Box Qt. 1pcs  
P.U. 10,50€

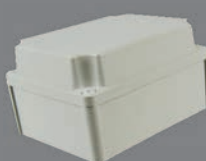

**201.200.150.125.GG**

Modelo B200  
Caixa Derivação IP 66  
Junction Box IP 66  
Cinza / Grey: Ral 7035  
200x150x125mm  
Emb./Box Qt. 1pcs  
P.U. 7,00€



Novos  
Produtos

HF  
Halogen  
FREE

SOFIX



## Abraçadeira Simples de Fixação para Tubo

### 250.001.016.CZ

Abraçadeira Simples 16mm  
Ø 16-17mm  
Polegadas: 3/8"  
Cinza / Grey: Ral 7035  
Proteção UV  
Qt. Min.Venda 100pcs  
P.U. 0,195€

### 250.001.020.CZ

Abraçadeira Simples 20mm  
Ø 20-21mm  
Polegadas: 1/2"  
Cinza / Grey: Ral 7035  
Proteção UV  
Qt. Min.Venda 100pcs  
P.U. 0,222

### 250.001.025.CZ

Abraçadeira Simples 25mm  
Ø 25-26mm  
Polegadas: 3/4"  
Cinza / Grey: Ral 7035  
Proteção UV  
Qt. Min.Venda 100pcs  
P.U. 0,233€

### 250.001.032.CZ

Abraçadeira Simples 32mm  
Ø 30-32mm  
Polegadas: 1"  
Cinza / Grey: Ral 7035  
Proteção UV  
Qt. Min.Venda 50pcs  
P.U. 0,360€



## PACK Abraçadeira Simples de Fixação para Tubo

(Quantidade Mínima Venda Pack, completo)

### 250.001.016.CZ.PK

Abraçadeira Simples 16mm  
Ø 16-17mm  
Polegadas: 3/8"  
Cinza / Grey: Ral 7035  
Proteção UV  
Qt. Pack 2800pcs  
P.U. 0,170€

### 250.001.020.CZ.PK

Abraçadeira Simples 20mm  
Ø 20-21mm  
Polegadas: 1/2"  
Cinza / Grey: Ral 7035  
Proteção UV  
Qt. Pack 2800pcs  
P.U. 0,190€

### 250.001.025.CZ.PK

Abraçadeira Simples 25mm  
Ø 25-26mm  
Polegadas: 3/4"  
Cinza / Grey: Ral 7035  
Proteção UV  
Qt. Pack 2800pcs  
P.U. 0,200€

### 250.001.032.CZ.PK

Abraçadeira Simples 32mm  
Ø 30-32mm  
Polegadas: 1"  
Cinza / Grey: Ral 7035  
Proteção UV  
Qt. Pack 1400pcs  
P.U. 0,310€



## Abraçadeira Dupla de Fixação para Tubo

### 250.021.016.CZ

Abraçadeira Dupla 16mm  
Ø 15-16mm  
Polegadas: 3/8"  
Cinza / Grey: Ral 7035  
Proteção UV  
Qt. Min.Venda 100pcs  
P.U. 0,231€

### 250.021.020.CZ

Abraçadeira Dupla 20mm  
Ø 20-21mm  
Polegadas: 1/2"  
Cinza / Grey: Ral 7035  
Proteção UV  
Qt. Min.Venda 50pcs  
P.U. 0,272€

### 250.021.025.CZ

Abraçadeira Dupla 25mm  
Ø 25-26mm  
Polegadas: 3/4"  
Cinza / Grey: Ral 7035  
Proteção UV  
Qt. Min.Venda 50pcs  
P.U. 0,328€

### 250.021.032.CZ

Abraçadeira Dupla 32mm  
Ø 28-32mm  
Polegadas: 1"  
Cinza / Grey: Ral 7035  
Proteção UV  
Qt. Min.Venda 50pcs  
P.U. 0,444€



## PACK Abraçadeira Dupla de Fixação para Tubo

(Quantidade Mínima Venda, Pack completo)

### 250.021.016.CZ.PK

Abraçadeira Dupla 16mm  
Ø 15-16mm  
Polegadas: 3/8"  
Cinza / Grey: Ral 7035  
Proteção UV  
Qt. Pack 2800pcs  
P.U. 0,197€

### 250.021.020.CZ.PK

Abraçadeira Dupla 20mm  
Ø 20-21mm  
Polegadas: 1/2"  
Cinza / Grey: Ral 7035  
Proteção UV  
Qt. Pack 1400pcs  
P.U. 0,235€

### 250.021.025.CZ.PK

Abraçadeira Dupla 25mm  
Ø 25-26mm  
Polegadas: 3/4"  
Cinza / Grey: Ral 7035  
Proteção UV  
Qt. Pack 1400pcs  
P.U. 0,295€

### 250.021.032.CZ.PK

Abraçadeira Dupla 32mm  
Ø 28-32mm  
Polegadas: 1"  
Cinza / Grey: Ral 7035  
Proteção UV  
Qt. Pack 1400pcs  
P.U. 0,410€



# Lineares em Led

Opção Casambi e Dalli por Encomenda

CASAMBI



### CASAMBI



Perfil em Alumínio para Fita Flexível, não Electrificado  
Aluminium Profile for flexivel Strip. Without Assembled



### Lapa 76

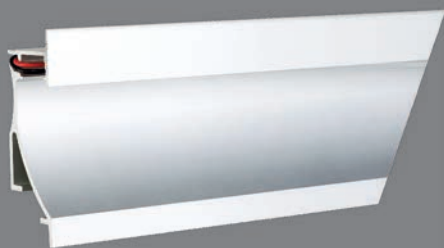

### Chelas 18

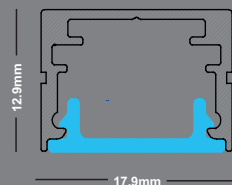

Perfil de Alumínio com Difusor e sem Barra Led  
Aluminium profile with Difusor, without Led

					€
097.1000ACO.000	Difusor Opalino	1000mm	Acet. Nat./Anodized	P.U.	8,50
097.2000ACO.000	Difusor Opalino	2000mm	Acet. Nat./Anodized	P.U.	17,00
097.1000WO.000	Difusor Opalino	1000mm	Branco	P.U.	8,50
097.2000WO.000	Difusor Opalino	2000mm	Branco	P.U.	17,00
097.1000ACC.000	Difusor Transparente	1000mm	Acet. Nat./Anodized	P.U.	8,50
097.2000ACC.000	Difusor Transparente	2000mm	Acet. Nat./Anodized	P.U.	17,00
097.1000WC.000	Difusor Transparente	1000mm	Branco	P.U.	8,50
097.2000WC.000	Difusor Transparente	2000mm	Branco	P.U.	17,00
097.TOPO.ACO.000	Topo			P.U.	0,70
097.MOLA.AC.O.000	Mola Fixação			P.U.	0,70

### Chelas 25

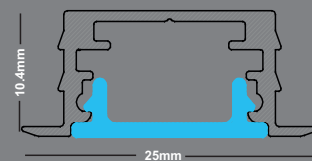

Perfil de Alumínio com Difusor e sem Barra Led  
Aluminium profile with Difusor, without Led

					€
098.1000ACO.000	Difusor Opalino	1000mm	Acet. Nat./Anodized	P.U.	8,50
098.2000ACO.000	Difusor Opalino	2000mm	Acet. Nat./Anodized	P.U.	17,00
098.1000ACC.000	Difusor Transparente	1000mm	Acet. Nat./Anodized	P.U.	8,50
098.2000ACC.000	Difusor Transparente	2000mm	Acet. Nat./Anodized	P.U.	17,00
098.TOPO.AC.O.000	098.TOPO.AC.O.000	Topo		P.U.	0,70
098.MOLA.AC.O.000	098.MOLA.AC.O.000	Mola Fixação		P.U.	0,70

### Chelas 28

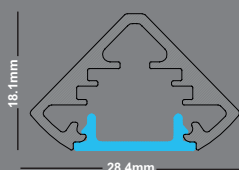

Perfil de Alumínio com Difusor e sem Barra Led  
Aluminium profile with Difusor, without Led

					€
099.1000ACO.000	Difusor Opalino	1000mm	Acet. Nat./Anodized	P.U.	17,00
099.2000ACO.000	Difusor Opalino	2000mm	Acet. Nat./Anodized	P.U.	34,00
099.1000ACC.000	Difusor Transparente	1000mm	Acet. Nat./Anodized	P.U.	17,00
099.2000ACC.000	Difusor Transparente	2000mm	Acet. Nat./Anodized	P.U.	34,00
099.TOPO.AC.O.000	Topo			P.U.	0,70
099.MOLA.AC.O.000	Mola Fixação			P.U.	0,70

Perfil de Alumínio ( Rodapé ) com Difusor e sem Barra Led

Código/Code	Led / Lm / W	L	Cor/Color	€
020.0500WO.000.00	Sem Led / Empty	500mm	BR/White	P.U. 25,00
020.0500ACO.000.00	Sem Led / Empty	500mm	Acet. Nat./ Nat.Satin	P.U. 25,00
020.1000WO.000.00	Sem Led / Empty	1000mm	BR/White	P.U. 50,00
020.1000ACO.000.00	Sem Led / Empty	1000mm	Acet. Nat./ Nat.Satin	P.U. 50,00
020.1500WO.000.00	Sem Led / Empty	1500mm	BR/White	P.U. 75,00
020.1500ACO.000.00	Sem Led / Empty	1500mm	Acet. Nat./ Nat.Satin	P.U. 75,00
020.2000WO.000.00	Sem Led / Empty	2000mm	BR/White	P.U. 100,00
020.2000ACO.000.00	Sem Led / Empty	2000mm	Acet. Nat./ Nat.Satin	P.U. 100,00
020.2500WO.000.00	Sem Led / Empty	2500mm	BR/White	P.U. 125,00
020.2500ACO.000.00	Sem Led / Empty	2500mm	Acet. Nat./ Nat.Satin	P.U. 125,00
020.3000WO.000.00	Sem Led / Empty	3000mm	BR/White	P.U. 150,00
020.3000ACO.000.00	Sem Led / Empty	3000mm	Acet. Nat./ Nat.Satin	P.U. 150,00
020.TOPOWO.000.00	Sem Led / Empty		BR/White	P.U. 7,00
020.TOPOACO.000.00	Sem Led / Empty		Acet. Nat./ Nat.Satin	P.U. 7,00

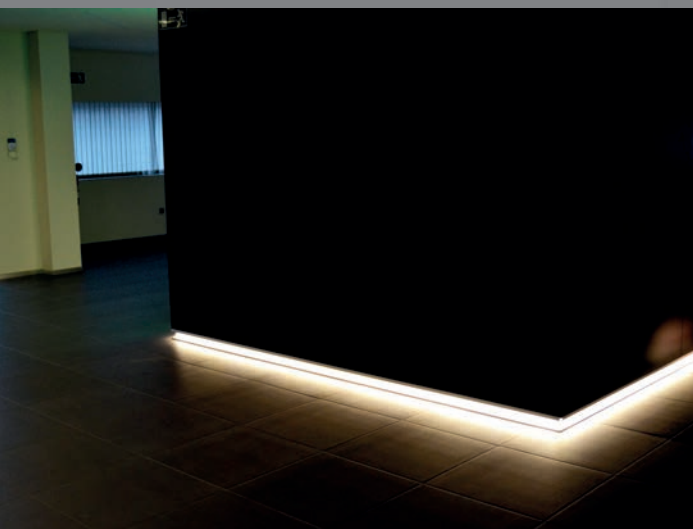

# Lumiar 46

Opção Casambi e Dali por Encomenda

soflight®



CASAMBI

DALI 2

Luminária em Alumínio Extrudido c/ Barra Led e Driver  
Extruded Aluminium Equipped with Led PCB and Driver

Led: **OSRAM**

Driver: **MLV** ou / or **TRIDONIC**

Placa Led 50 000 Horas; 5 Anos Garantia

Led PCB 50 000 Hours; 5 Years Warranty



Eletrificado com barra Led ( Osram ) Simples ( 1 Linha )

Assembled with Osram Led ( 1 Led Line )

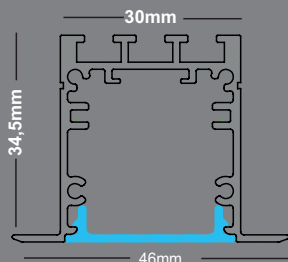

## Lumiar 46

Código/Code	Led / Lm / W	L	Cor/Color	€	Código/Code	Led / Lm / W	L	Cor/Color	€
010.0580WO.001.82	2700K / 1220Lm / 15W	580mm	BR/White	P.U. 110,00	010.1700WO.001.82	2700K / 3700Lm / 35W	1700mm	BR/White	P.U. 185,00
010.0580ACO.001.82	2700K / 1220Lm / 15W	580mm	Acet. Nat./ Nat.Satin	P.U. 110,00	010.1700ACO.001.82	2700K / 3700Lm / 35W	1700mm	Acet. Nat./Anodized	P.U. 185,00
010.0580WO.001.84	4000K / 1300Lm / 15W	580mm	BR/White	P.U. 110,00	010.1700WO.001.84	4000K / 3800Lm / 35W	1700mm	BR/White	P.U. 185,00
010.0580ACO.001.84	4000K / 1300Lm / 15W	580mm	Acet. Nat./ Nat.Satin	P.U. 110,00	010.1700ACO.001.84	4000K / 3800Lm / 35W	1700mm	Acet. Nat./Anodized	P.U. 185,00
010.0580WO.001.54	5700K / 1350Lm / 15W	580mm	BR/White	P.U. 110,00	010.1700WO.001.54	5700K / 3900Lm / 35W	1700mm	BR/White	P.U. 185,00
010.0580ACO.001.54	5700K / 1350Lm / 15W	580mm	Acet. Nat./ NAT.Satin	P.U. 110,00	010.1700ACO.001.54	5700K / 3900Lm / 35W	1700mm	Acet. Nat./Anodized	P.U. 185,00
010.0860WO.001.82	2700K / 1850Lm / 20W	860mm	BR/White	P.U. 125,00	010.1980WO.001.82	2700K / 4300Lm / 40W	1980mm	BR/White	P.U. 200,00
010.0860ACO.001.82	2700K / 1850Lm / 20W	860mm	Acet. Nat./ Nat.Satin	P.U. 125,00	010.1980ACO.001.82	2700K / 4300Lm / 40W	1980mm	Acet. Nat./Anodized	P.U. 200,00
010.0860WO.001.84	4000K / 1900Lm / 20W	860mm	BR/White	P.U. 125,00	010.1980WO.001.84	4000K / 4450Lm / 40W	1980mm	BR/White	P.U. 200,00
010.0860ACO.001.84	4000K / 1900Lm / 20W	860mm	Acet. Nat./ Nat.Satin	P.U. 125,00	010.1980ACO.001.84	4000K / 4450Lm / 40W	1980mm	Acet. Nat./Anodized	P.U. 200,00
010.0860WO.001.54	5700K / 1950Lm / 20W	860mm	BR/White	P.U. 125,00	010.1980WO.001.54	5700K / 4550Lm / 40W	1980mm	BR/White	P.U. 200,00
010.0860ACO.001.54	5700K / 1950Lm / 20W	860mm	Acet. Nat./ NAT.Satin	P.U. 125,00	010.1980ACO.001.54	5700K / 4550Lm / 40W	1980mm	Acet. Nat./Anodized	P.U. 200,00
010.1140WO.001.82	2700K / 2450Lm / 25W	1140mm	BR/White	P.U. 152,00	010.2260WO.001.82	2700K / 4900Lm / 45W	2260mm	BR/White	P.U. 218,00
010.1140ACO.001.82	2700K / 2450Lm / 25W	1140mm	Acet. Nat./ Nat. Satin	P.U. 152,00	010.2260ACO.001.82	2700K / 4900Lm / 45W	2260mm	Acet. Nat./Anodized	P.U. 218,00
010.1140WO.001.84	4000K / 2550Lm / 25W	1140mm	BR/White	P.U. 152,00	010.2260WO.001.84	4000K / 5050Lm / 45W	2260mm	BR/White	P.U. 218,00
010.1140ACO.001.84	4000K / 2550Lm / 25W	1140mm	Acet. Nat./ Nat.Satin	P.U. 152,00	010.2260ACO.001.84	4000K / 5050Lm / 45W	2260mm	Acet. Nat./Anodized	P.U. 218,00
010.1140WO.001.54	5700K / 2650Lm / 25W	1140mm	BR/White	P.U. 152,00	010.2260WO.001.54	5700K / 5200Lm / 45W	2260mm	BR/White	P.U. 218,00
010.1140ACO.001.54	5700K / 2650Lm / 25W	1140mm	Acet. Nat./ Nat. Satin	P.U. 152,00	010.2260ACO.001.54	5700K / 5200Lm / 45W	2260mm	Acet. Nat./Anodized	P.U. 218,00
010.1420WO.001.82	2700K / 3050Lm / 30W	1420mm	BR/White	P.U. 167,00	010.2540WO.001.82	2700K / 5500Lm / 50W	2540mm	BR/White	P.U. 231,00
010.1420ACO.001.82	2700K / 3050Lm / 30W	1420mm	Acet. Nat./ Nat. Satin	P.U. 167,00	010.2540ACO.001.82	2700K / 5500Lm / 50W	2540mm	Acet. Nat./Anodized	P.U. 231,00
010.1420WO.001.84	4000K / 3150Lm / 30W	1420mm	BR/White	P.U. 167,00	010.2540WO.001.84	4000K / 5700Lm / 50W	2540mm	BR/White	P.U. 231,00
010.1420ACO.001.84	4000K / 3150Lm / 30W	1420mm	Acet. Nat./ Nat. Satin	P.U. 167,00	010.2540ACO.001.84	4000K / 5700Lm / 50W	2540mm	Acet. Nat./Anodized	P.U. 231,00
010.1420WO.001.54	5700K / 3250Lm / 30W	1420mm	BR/White	P.U. 167,00	010.2540WO.001.54	5700K / 5900Lm / 50W	2540mm	BR/White	P.U. 231,00
010.1420ACO.001.54	5700K / 3250Lm / 30W	1420mm	Acet. Nat./Anodized	P.U. 167,00	010.2540ACO.001.54	5700K / 5900Lm / 50W	2540mm	Acet. Nat./Anodized	P.U. 231,00
					010.2820WO.001.82	2700K / 6100Lm / 55W	2820mm	BR/White	P.U. 254,00
					010.2820ACO.001.82	2700K / 6100Lm / 55W	2820mm	Acet. Nat./Anodized	P.U. 254,00
					010.2820WO.001.84	4000K / 6300Lm / 55W	2820mm	BR/White	P.U. 254,00
					010.2820ACO.001.84	4000K / 6300Lm / 55W	2820mm	Acet. Nat./Anodized	P.U. 254,00
					010.2820WO.001.54	5700K / 6500Lm / 55W	2820mm	BR/White	P.U. 254,00
					010.2820ACO.001.54	5700K / 6500Lm / 55W	2820mm	Acet. Nat./Anodized	P.U. 254,00

Opções por Encomenda: Dimensões Específicas (mínimo 56mm) - Kit de Emergência - DALI - Dimável - Sistema de controle de Iluminação ( lux contol )

Obs: Não ligar com Sensores

Devido à constante evolução deste tipo de produtos a marca dos Leds e Drivers assim como as características técnicas podem ser alterados sem aviso prévio, por favor consultar o folheto ou solicite a ficha técnica atualizada dos artigos pretendidos

Opção Casambi e Dali por Encomenda

## CASAMBI

## DALI 2

Luminária em Alumínio Extrudido c/ Barra Led e Driver  
Extruded Aluminium Equipped with Led PCB and Driver



Led: **OSRAM**

Driver: **MW** ou / or **TRIDONIC**

Placa Led 50 000 Horas; 5 Anos Garantia

Led PCB 50 000 Hours; 5 Years Warranty

Eletrificado com barra Led ( Osram ) Simples ( 1 Linha )  
Assembled with Osram Led ( 1 Led Line )

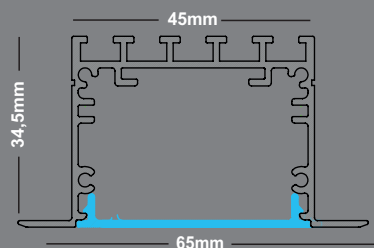

### Lumiar 65

Código/Code	Led / Lm / W	L	Cor/Color	€	Código/Code	Led / Lm / W	L	Cor/Color	€
011.0580WO.001.82	2700K / 1220Lm / 15W	580mm	BR/White	P.U. 116,00	011.1980WO.001.82	2700K / 4300Lm / 40W	1980mm	BR/White	P.U. 210,00
011.0580ACO.001.82	2700K / 1220Lm / 15W	580mm	Acet. Nat./ Nat.Satin	P.U. 116,00	011.1980ACO.001.82	2700K / 4300Lm / 40W	1980mm	Acet. Nat./Anodized	P.U. 210,00
011.0580WO.001.84	4000K / 1300Lm / 15W	580mm	BR/White	P.U. 116,00	011.1980WO.001.84	4000K / 4450Lm / 40W	1980mm	BR/White	P.U. 210,00
011.0580ACO.001.84	4000K / 1300Lm / 15W	580mm	Acet. Nat./ Nat.Satin	P.U. 116,00	011.1980ACO.001.84	4000K / 4450Lm / 40W	1980mm	Acet. Nat./Anodized	P.U. 210,00
011.0580WO.001.54	5700K / 1350Lm / 15W	580mm	BR/White	P.U. 116,00	011.1980WO.001.54	5700K / 4550Lm / 40W	1980mm	BR/White	P.U. 210,00
011.0580ACO.001.54	5700K / 1350Lm / 15W	580mm	Acet. Nat./ Nat.Satin	P.U. 116,00	011.1980ACO.001.54	5700K / 4550Lm / 40W	1980mm	Acet. Nat./Anodized	P.U. 210,00
011.0860WO.001.82	2700K / 1850Lm / 20W	860mm	BR/White	P.U. 131,00	011.2260WO.001.82	2700K / 4900Lm / 45W	2260mm	BR/White	P.U. 231,00
011.0860ACO.001.82	2700K / 1850Lm / 20W	860mm	Acet. Nat./ Nat.Satin	P.U. 131,00	011.2260ACO.001.82	2700K / 4900Lm / 45W	2260mm	Acet. Nat./Anodized	P.U. 231,00
011.0860WO.001.84	4000K / 1900Lm / 20W	860mm	BR/White	P.U. 131,00	011.2260WO.001.84	4000K / 5050Lm / 45W	2260mm	BR/White	P.U. 231,00
011.0860ACO.001.84	4000K / 1900Lm / 20W	860mm	Acet. Nat./ Nat.Satin	P.U. 131,00	011.2260ACO.001.84	4000K / 5050Lm / 45W	2260mm	Acet. Nat./Anodized	P.U. 231,00
011.0860WO.001.54	5700K / 1950Lm / 20W	860mm	BR/White	P.U. 131,00	011.2260WO.001.54	5700K / 5200Lm / 45W	2260mm	BR/White	P.U. 231,00
011.0860ACO.001.54	5700K / 1950Lm / 20W	860mm	Acet. Nat./ Nat.Satin	P.U. 131,00	011.2260ACO.001.54	5700K / 5200Lm / 45W	2260mm	Acet. Nat./Anodized	P.U. 231,00
011.1140WO.001.82	2700K / 2450Lm / 25W	1140mm	BR/White	P.U. 158,00	011.2540WO.001.82	2700K / 5500Lm / 50W	2540mm	BR/White	P.U. 243,00
011.1140ACO.001.82	2700K / 2450Lm / 25W	1140mm	Acet. Nat./ Nat. Satin	P.U. 158,00	011.2540ACO.001.82	2700K / 5500Lm / 50W	2540mm	Acet. Nat./Anodized	P.U. 243,00
011.1140WO.001.84	4000K / 2550Lm / 25W	1140mm	BR/White	P.U. 158,00	011.2540WO.001.84	4000K / 5700Lm / 50W	2540mm	BR/White	P.U. 243,00
011.1140ACO.001.84	4000K / 2550Lm / 25W	1140mm	Acet. Nat./ Nat.Satin	P.U. 158,00	011.2540ACO.001.84	4000K / 5700Lm / 50W	2540mm	Acet. Nat./Anodized	P.U. 243,00
011.1140WO.001.54	5700K / 2650Lm / 25W	1140mm	BR/White	P.U. 158,00	011.2540WO.001.54	5700K / 5900Lm / 50W	2540mm	BR/White	P.U. 243,00
011.1140ACO.001.54	5700K / 2650Lm / 25W	1140mm	Acet. Nat./ Nat. Satin	P.U. 158,00	011.2540ACO.001.54	5700K / 5900Lm / 50W	2540mm	Acet. Nat./Anodized	P.U. 243,00
011.1420WO.001.82	2700K / 3050Lm / 30W	1420mm	BR/White	P.U. 174,00	011.2820WO.001.82	2700K / 6100Lm / 55W	2820mm	BR/White	P.U. 267,00
011.1420ACO.001.82	2700K / 3050Lm / 30W	1420mm	Acet. Nat./ Nat. Satin	P.U. 174,00	011.2820ACO.001.82	2700K / 6100Lm / 55W	2820mm	Acet. Nat./Anodized	P.U. 267,00
011.1420WO.001.84	4000K / 3150Lm / 30W	1420mm	BR/White	P.U. 174,00	011.2820WO.001.84	4000K / 6300Lm / 55W	2820mm	BR/White	P.U. 267,00
011.1420ACO.001.84	4000K / 3150Lm / 30W	1420mm	Acet. Nat./ Nat. Satin	P.U. 174,00	011.2820ACO.001.84	4000K / 6300Lm / 55W	2820mm	Acet. Nat./Anodized	P.U. 267,00
011.1420WO.001.54	5700K / 3250Lm / 30W	1420mm	BR/White	P.U. 174,00	011.2820WO.001.54	5700K / 6500Lm / 55W	2820mm	BR/White	P.U. 267,00
011.1420ACO.001.54	5700K / 3250Lm / 30W	1420mm	Acet. Nat./Anodized	P.U. 174,00	011.2820ACO.001.54	5700K / 6500Lm / 55W	2820mm	Acet. Nat./Anodized	P.U. 267,00
011.1700WO.001.82	2700K / 3700Lm / 35W	1700mm	BR/White	P.U. 194,00					
011.1700ACO.001.82	2700K / 3700Lm / 35W	1700mm	Acet. Nat./ Nat. Satin	P.U. 194,00					
011.1700WO.001.84	4000K / 3800Lm / 35W	1700mm	BR/White	P.U. 194,00					
011.1700ACO.001.84	4000K / 3800Lm / 35W	1700mm	Acet. Nat./ Nat. Satin	P.U. 194,00					
011.1700WO.001.54	5700K / 3900Lm / 35W	1700mm	BR/White	P.U. 194,00					
011.1700ACO.001.54	5700K / 3900Lm / 35W	1700mm	Acet. Nat./Anodized	P.U. 194,00					

**Opções por Encomenda: Dimensões Específicas (mínimo 56mm) - Kit de Emergência - DALI - Dimável - Sistema de controle de Iluminação ( lux contol )**

**Obs: Não ligar com Sensores**

Opção Casambi e Dali por Encomenda

## CASAMBI

## DALI 2



Luminária em Alumínio Extrudido c/ Barra Led e Driver  
Extruded Aluminium Equipped with Led PCB and Driver

Led: **OSRAM**

Driver: **MTW** ou / or **TRIDONIC**

Placa Led 50 000 Horas; 5 Anos Garantia

Led PCB 50 000 Hours; 5 Years Warranty

Eletrificado com barra Led ( Osram ) Dupla ( 2 Linhas )  
Assembled with Osram Led ( 2 Led Line )

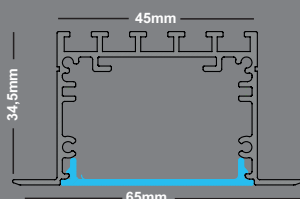

### Lumiar 65

Código/Code	Led / Lm / W	L	Cor/Color	€	Código/Code	Led / Lm / W	L	Cor/Color	€
011.0580WO.002.82	2700K / 2450Lm / 25W	580mm	BR/White	P.U. 130,00	011.1980WO.002.82	2700K / 8550Lm / 75W	1980mm	BR/White	P.U. 306,00
011.0580ACO.002.82	2700K / 2450Lm / 25W	580mm	Acet. Nat./ Nat.Satin	P.U. 130,00	011.1980ACO.002.82	2700K / 8550Lm / 75W	1980mm	Acet. Nat./Anodized	P.U. 306,00
011.0580ANO.002.82	2700K / 2450Lm / 25W	580mm	Antr./Dark Grey						
011.0580WO.002.84	4000K / 2550Lm / 25W	580mm	BR/White	P.U. 130,00	011.1980WO.002.84	4000K / 8850Lm / 75W	1980mm	BR/White	P.U. 306,00
011.0580ACO.002.84	4000K / 2550Lm / 25W	580mm	Acet. Nat./ Nat.Satin	P.U. 130,00	011.1980ACO.002.84	4000K / 8850Lm / 75W	1980mm	Acet. Nat./Anodized	P.U. 306,00
011.0580WO.002.54	5700K / 2620Lm / 25W	580mm	BR/White	P.U. 130,00	011.1980WO.002.54	5700K / 9150Lm / 75W	1980mm	BR/White	P.U. 306,00
011.0580ACO.002.54	5700K / 2620Lm / 25W	580mm	Acet. Nat./ Nat.Satin	P.U. 130,00	011.1980ACO.002.54	5700K / 9150Lm / 75W	1980mm	Acet. Nat./Anodized	P.U. 306,00
011.0860WO.002.82	2700K / 3700Lm / 35W	860mm	BR/White	P.U. 147,00	011.2260WO.002.82	2700K / 9750Lm / 90W	2260mm	BR/White	P.U. 330,00
011.0860ACO.002.82	2700K / 3700Lm / 35W	860mm	Acet. Nat./ Nat.Satin	P.U. 147,00	011.2260ACO.002.82	2700K / 9750Lm / 90W	2260mm	Acet. Nat./Anodized	P.U. 330,00
011.0860WO.002.84	4000K / 3800Lm / 35W	860mm	BR/White	P.U. 147,00	011.2260WO.002.84	4000K / 10100Lm / 90W	2260mm	BR/White	P.U. 330,00
011.0860ACO.002.84	4000K / 3800Lm / 35W	860mm	Acet. Nat./ Nat.Satin	P.U. 147,00	011.2260ACO.002.84	4000K / 10100Lm / 90W	2260mm	Acet. Nat./Anodized	P.U. 330,00
011.0860WO.002.54	5700K / 3900Lm / 35W	860mm	BR/White	P.U. 147,00	011.2260WO.002.54	5700K / 10400Lm / 90W	2260mm	BR/White	P.U. 330,00
011.0860ACO.002.54	5700K / 3900Lm / 35W	860mm	Acet. Nat./ Nat.Satin	P.U. 147,00	011.2260ACO.002.54	5700K / 10400Lm / 90W	2260mm	Acet. Nat./Anodized	P.U. 330,00
011.1140WO.002.82	2700K / 4900Lm / 45W	1140mm	BR/White	P.U. 172,00	011.2540WO.002.82	2700K / 11000Lm / 100W	2540mm	BR/White	P.U. 348,00
011.1140ACO.002.82	2700K / 4900Lm / 45W	1140mm	Acet. Nat./ Nat. Satin	P.U. 172,00	011.2540ACO.002.82	2700K / 11000Lm / 100W	2540mm	Acet. Nat./Anodized	P.U. 348,00
011.1140WO.002.84	4000K / 5050Lm / 45W	1140mm	BR/White	P.U. 172,00	011.2540WO.002.84	4000K / 11350Lm / 100W	2540mm	BR/White	P.U. 348,00
011.1140ACO.002.84	4000K / 5050Lm / 45W	1140mm	Acet. Nat./ Nat.Satin	P.U. 172,00	011.2540ACO.002.84	4000K / 11350Lm / 100W	2540mm	Acet. Nat./Anodized	P.U. 348,00
011.1140WO.002.54	5700K / 5200Lm / 45W	1140mm	BR/White	P.U. 172,00	011.2540WO.002.54	5700K / 11700Lm / 100W	2540mm	BR/White	P.U. 348,00
011.1140ACO.002.54	5700K / 5200Lm / 45W	1140mm	Acet. Nat./ Nat. Satin	P.U. 172,00	011.2540ACO.002.54	5700K / 11700Lm / 100W	2540mm	Acet. Nat./Anodized	P.U. 348,00
011.1420WO.002.82	2700K / 6100Lm / 55W	1420mm	BR/White	P.U. 186,00	011.2820WO.002.82	2700K / 12200Lm / 110W	2820mm	BR/White	P.U. 370,00
011.1420ACO.002.82	2700K / 6100Lm / 55W	1420mm	Acet. Nat./ Nat. Satin	P.U. 186,00	011.2820ACO.002.82	2700K / 12200Lm / 110W	2820mm	Acet. Nat./Anodized	P.U. 370,00
011.1420WO.002.84	4000K / 6300Lm / 55W	1420mm	BR/White	P.U. 186,00	011.2820WO.002.84	4000K / 12600Lm / 110W	2820mm	BR/White	P.U. 370,00
011.1420ACO.002.84	4000K / 6300Lm / 55W	1420mm	Acet. Nat./ Nat. Satin	P.U. 186,00	011.2820ACO.002.84	4000K / 12600Lm / 110W	2820mm	Acet. Nat./Anodized	P.U. 370,00
011.1420WO.002.54	5700K / 6500Lm / 55W	1420mm	BR/White	P.U. 186,00	011.2820WO.002.54	5700K / 13050Lm / 110W	2820mm	BR/White	P.U. 370,00
011.1420ACO.002.54	5700K / 6500Lm / 55W	1420mm	Acet. Nat./Anodized	P.U. 186,00	011.2820ACO.002.54	5700K / 13050Lm / 110W	2820mm	Acet. Nat./Anodized	P.U. 370,00
011.1700WO.002.82	2700K / 7300Lm / 65W	1700mm	BR/White	P.U. 210,00					
011.1700ACO.002.82	2700K / 7300Lm / 65W	1700mm	Acet. Nat./ Nat. Satin	P.U. 210,00					
011.1700WO.002.84	4000K / 7600Lm / 65W	1700mm	BR/White	P.U. 210,00					
011.1700ACO.002.84	4000K / 7600Lm / 65W	1700mm	Acet. Nat./ Nat. Satin	P.U. 210,00					
011.1700WO.002.54	5700K / 7850Lm / 65W	1700mm	BR/White	P.U. 210,00					
011.1700ACO.002.54	5700K / 7850Lm / 65W	1700mm	Acet. Nat./Anodized	P.U. 210,00					

Opções por Encomenda: Dimensões Específicas (mínimo 56mm) - Kit de Emergência - DALI - Dimável - Sistema de controle de Iluminação ( lux contol )

Obs: Não ligar com Sensores

Devido à constante evolução deste tipo de produtos a marca dos Led's e Drivers assim como as características técnicas podem ser alterados sem aviso prévio, por favor consultar o folheto ou solicitar a ficha técnica atualizada dos artigos pretendidos.



Opção Casambi e Dali por Encomenda

## CASAMBI



Luminária em Alumínio Extrudido c/ Barra Led e Driver  
Extruded Aluminium Equipped with Led PCB and Driver



Led: **OSRAM**

Driver: **MY** ou / or **TRIDONIC**

Placa Led 50 000 Horas; 5 Anos Garantia

Led PCB 50 000 Hours; 5 Years Warranty

Eletrificado com barra Led ( Osram ) Simples ( 1 Linha )  
Assembled with Osram Led ( 1 Led Line )

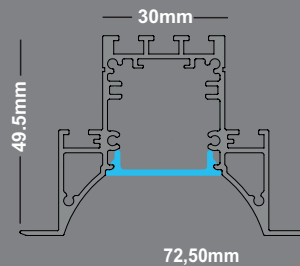

## Rossio 72

Código/Code	Led / Lm / W	L	Cor/Color	€	Código/Code	Led / Lm / W	L	Cor/Color	€
012.0580WO.001.82	2700K / 1220Lm / 15W	580mm	BR/White	P.U. 125,00	012.1700WO.001.82	2700K / 3700Lm / 35W	1700mm	BR/White	P.U. 208,00
012.0580ACO.001.82	2700K / 1220Lm / 15W	580mm	Acet. Nat./ Nat.Satin	P.U. 125,00	012.1700ACO.001.82	2700K / 3700Lm / 35W	1700mm	Acet. Nat./Anodized	P.U. 208,00
012.0580WO.001.84	4000K / 1300Lm / 15W	580mm	BR/White	P.U. 125,00	012.1700WO.001.84	4000K / 3800Lm / 35W	1700mm	BR/White	P.U. 208,00
012.0580ACO.001.84	4000K / 1300Lm / 15W	580mm	Acet. Nat./ Nat.Satin	P.U. 125,00	012.1700ACO.001.84	4000K / 3800Lm / 35W	1700mm	Acet. Nat./Anodized	P.U. 208,00
012.0580WO.001.54	5700K / 1350Lm / 15W	580mm	BR/White	P.U. 125,00	012.1700WO.001.54	5700K / 3900Lm / 35W	1700mm	BR/White	P.U. 208,00
012.0580ACO.001.54	5700K / 1350Lm / 15W	580mm	Acet. Nat./ Nat.Satin	P.U. 125,00	012.1700ACO.001.54	5700K / 3900Lm / 35W	1700mm	Acet. Nat./Anodized	P.U. 208,00
012.0860WO.001.82	2700K / 1850Lm / 20W	860mm	BR/White	P.U. 140,00	012.1980WO.001.82	2700K / 4300Lm / 40W	1980mm	BR/White	P.U. 230,00
012.0860ACO.001.82	2700K / 1850Lm / 20W	860mm	Acet. Nat./ Nat.Satin	P.U. 140,00	012.1980ACO.001.82	2700K / 4300Lm / 40W	1980mm	Acet. Nat./Anodized	P.U. 230,00
012.0860WO.001.84	4000K / 1900Lm / 20W	860mm	BR/White	P.U. 140,00	012.1980WO.001.84	4000K / 4450Lm / 40W	1980mm	BR/White	P.U. 230,00
012.0860ACO.001.84	4000K / 1900Lm / 20W	860mm	Acet. Nat./ Nat.Satin	P.U. 140,00	012.1980ACO.001.84	4000K / 4450Lm / 40W	1980mm	Acet. Nat./Anodized	P.U. 230,00
012.0860WO.001.54	5700K / 1950Lm / 20W	860mm	BR/White	P.U. 140,00	012.1980WO.001.54	5700K / 4550Lm / 40W	1980mm	BR/White	P.U. 230,00
012.0860ACO.001.54	5700K / 1950Lm / 20W	860mm	Acet. Nat./ Nat.Satin	P.U. 140,00	012.1980ACO.001.54	5700K / 4550Lm / 40W	1980mm	Acet. Nat./Anodized	P.U. 230,00
012.1140WO.001.82	2700K / 2450Lm / 25W	1140mm	BR/White	P.U. 171,00	012.2260WO.001.82	2700K / 4900Lm / 45W	2260mm	BR/White	P.U. 250,00
012.1140ACO.001.82	2700K / 2450Lm / 25W	1140mm	Acet. Nat./ Nat. Satin	P.U. 171,00	012.2260ACO.001.82	2700K / 4900Lm / 45W	2260mm	Acet. Nat./Anodized	P.U. 250,00
012.1140WO.001.84	4000K / 2550Lm / 25W	1140mm	BR/White	P.U. 171,00	012.2260WO.001.84	4000K / 5050Lm / 45W	2260mm	BR/White	P.U. 250,00
012.1140ACO.001.84	4000K / 2550Lm / 25W	1140mm	Acet. Nat./ Nat.Satin	P.U. 171,00	012.2260ACO.001.84	4000K / 5050Lm / 45W	2260mm	Acet. Nat./Anodized	P.U. 250,00
012.1140WO.001.54	5700K / 2650Lm / 25W	1140mm	BR/White	P.U. 171,00	012.2260WO.001.54	5700K / 5200Lm / 45W	2260mm	BR/White	P.U. 250,00
012.1140ACO.001.54	5700K / 2650Lm / 25W	1140mm	Acet. Nat./ Nat. Satin Antr./Dark Grey	P.U. 171,00	012.2260ACO.001.54	5700K / 5200Lm / 45W	2260mm	Acet. Nat./Anodized	P.U. 250,00
012.1420WO.001.82	2700K / 3050Lm / 30W	1420mm	BR/White	P.U. 186,00	012.2540WO.001.82	2700K / 5500Lm / 50W	2540mm	BR/White	P.U. 265,00
012.1420ACO.001.82	2700K / 3050Lm / 30W	1420mm	Acet. Nat./ Nat. Satin	P.U. 186,00	012.2540ACO.001.82	2700K / 5500Lm / 50W	2540mm	Acet. Nat./Anodized	P.U. 265,00
012.1420WO.001.84	4000K / 3150Lm / 30W	1420mm	BR/White	P.U. 186,00	012.2540WO.001.84	4000K / 5700Lm / 50W	2540mm	BR/White	P.U. 265,00
012.1420ACO.001.84	4000K / 3150Lm / 30W	1420mm	Acet. Nat./ Nat. Satin	P.U. 186,00	012.2540ACO.001.84	4000K / 5700Lm / 50W	2540mm	Acet. Nat./Anodized	P.U. 265,00
012.1420WO.001.54	5700K / 3250Lm / 30W	1420mm	BR/White	P.U. 186,00	012.2540WO.001.54	5700K / 5900Lm / 50W	2540mm	BR/White	P.U. 265,00
012.1420ACO.001.54	5700K / 3250Lm / 30W	1420mm	Acet. Nat./Anodized	P.U. 186,00	012.2540ACO.001.54	5700K / 5900Lm / 50W	2540mm	Acet. Nat./Anodized	P.U. 265,00
					012.2820WO.001.82	2700K / 6100Lm / 55W	2820mm	BR/White	P.U. 295,00
					012.2820ACO.001.82	2700K / 6100Lm / 55W	2820mm	Acet. Nat./Anodized	P.U. 295,00
					012.2820WO.001.84	4000K / 6300Lm / 55W	2820mm	BR/White	P.U. 295,00
					012.2820ACO.001.84	4000K / 6300Lm / 55W	2820mm	Acet. Nat./Anodized	P.U. 295,00
					012.2820WO.001.54	5700K / 6500Lm / 55W	2820mm	BR/White	P.U. 295,00
					012.2820ACO.001.54	5700K / 6500Lm / 55W	2820mm	Acet. Nat./Anodized	P.U. 295,00

Opções por Encomenda: Dimensões Específicas (mínimo 56mm) - Kit de Emergência - DALI - Dimável - Sistema de controle de Iluminação ( lux contol )

Obs: Não ligar com Sensores

Devido à constante evolução deste tipo de produtos a marca dos Led's e Drivers assim como as características técnicas podem ser alterados sem aviso prévio, por favor consultar o folheto ou solicitar a ficha técnica atualizada dos artigos pretendidos.



Opção Casambi e Dali por Encomenda

## CASAMBI

## DALI 2

Luminária em Alumínio Extrudido c/ Barra Led e Driver  
Extruded Aluminium Equipped with Led PCB and Driver



Led: **OSRAM**

Driver: ou / or

Eletrificado com barra Led ( Osram ) Simples ( 1 Linha )  
Assembled with Osram Led ( 1 Led Line )

Placa Led 50 000 Horas; 5 Anos Garantia

Led PCB 50 000 Hours; 5 Years Warranty

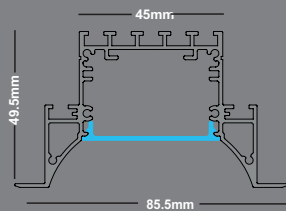

### Rossio 85

Código/Code	Led / Lm / W	L	Cor/Color	€	Código/Code	Led / Lm / W	L	Cor/Color	€
013.0580WO.001.82	2700K / 1220Lm / 15W	580mm	BR/White	P.U. 125,00	013.1980WO.001.82	2700K / 4300Lm / 40W	1980mm	BR/White	P.U. 235,00
013.0580ACO.001.82	2700K / 1220Lm / 15W	580mm	Acet. Nat./ Nat.Satin	P.U. 125,00	013.1980ACO.001.82	2700K / 4300Lm / 40W	1980mm	Acet. Nat./Anodized	P.U. 235,00
013.0580WO.001.84	4000K / 1300Lm / 15W	580mm	BR/White	P.U. 125,00	013.1980WO.001.84	4000K / 4450Lm / 40W	1980mm	BR/White	P.U. 235,00
013.0580ACO.001.84	4000K / 1300Lm / 15W	580mm	Acet. Nat./ Nat.Satin	P.U. 125,00	013.1980ACO.001.84	4000K / 4450Lm / 40W	1980mm	Acet. Nat./Anodized	P.U. 235,00
013.0580WO.001.54	5700K / 1300Lm / 15W	580mm	BR/White	P.U. 125,00	013.1980WO.001.54	5700K / 4550Lm / 40W	1980mm	BR/White	P.U. 235,00
013.0580ACO.001.54	5700K / 3150Lm / 15W	580mm	Acet. Nat./ Nat.Satin	P.U. 125,00	013.1980ACO.001.54	5700K / 4550Lm / 40W	1980mm	Acet. Nat./Anodized	P.U. 235,00
013.0860WO.001.82	2700K / 1850Lm / 20W	860mm	BR/White	P.U. 145,00	013.2260WO.001.82	2700K / 4900Lm / 45W	2260mm	BR/White	P.U. 255,00
013.0860ACO.001.82	2700K / 1850Lm / 20W	860mm	Acet. Nat./ Nat.Satin	P.U. 145,00	013.2260ACO.001.82	2700K / 4900Lm / 45W	2260mm	Acet. Nat./Anodized	P.U. 255,00
013.0860WO.001.84	4000K / 1900Lm / 20W	860mm	BR/White	P.U. 145,00	013.2260WO.001.84	4000K / 5050Lm / 45W	2260mm	BR/White	P.U. 255,00
013.0860ACO.001.84	4000K / 1900Lm / 20W	860mm	Acet. Nat./ Nat.Satin	P.U. 145,00	013.2260ACO.001.84	4000K / 5050Lm / 45W	2260mm	Acet. Nat./Anodized	P.U. 255,00
013.0860WO.001.54	5700K / 1950Lm / 20W	860mm	BR/White	P.U. 145,00	013.2260WO.001.54	5700K / 5200Lm / 45W	2260mm	BR/White	P.U. 255,00
013.0860ACO.001.54	5700K / 1950Lm / 20W	860mm	Acet. Nat./ Nat.Satin	P.U. 145,00	013.2260ACO.001.54	5700K / 5200Lm / 45W	2260mm	Acet. Nat./Anodized	P.U. 255,00
013.1140WO.001.82	2700K / 2450Lm / 25W	1140mm	BR/White	P.U. 175,00	013.2540WO.001.82	2700K / 5500Lm / 50W	2540mm	BR/White	P.U. 275,00
013.1140ACO.001.82	2700K / 2450Lm / 25W	1140mm	Acet. Nat./ Nat. Satin	P.U. 175,00	013.2540ACO.001.82	2700K / 5500Lm / 50W	2540mm	Acet. Nat./Anodized	P.U. 275,00
013.1140WO.001.84	4000K / 2550Lm / 25W	1140mm	BR/White	P.U. 175,00	013.2540WO.001.84	4000K / 5700Lm / 50W	2540mm	BR/White	P.U. 275,00
013.1140ACO.001.84	4000K / 2550Lm / 25W	1140mm	Acet. Nat./ Nat.Satin	P.U. 175,00	013.2540ACO.001.84	4000K / 5700Lm / 50W	2540mm	Acet. Nat./Anodized	P.U. 275,00
013.1140WO.001.54	5700K / 2650Lm / 25W	1140mm	BR/White	P.U. 175,00	013.2540WO.001.54	5700K / 5900Lm / 50W	2540mm	BR/White	P.U. 275,00
013.1140ACO.001.54	5700K / 2650Lm / 25W	1140mm	Acet. Nat./ Nat. Satin	P.U. 175,00	013.2540ACO.001.54	5700K / 5900Lm / 50W	2540mm	Acet. Nat./Anodized	P.U. 275,00
013.1420WO.001.82	2700K / 3050Lm / 30W	1420mm	BR/White	P.U. 190,00	013.2820WO.001.82	2700K / 6100Lm / 55W	2820mm	BR/White	P.U. 300,00
013.1420ACO.001.82	2700K / 3050Lm / 30W	1420mm	Acet. Nat./ Nat. Satin	P.U. 190,00	013.2820ACO.001.82	2700K / 6100Lm / 55W	2820mm	Acet. Nat./Anodized	P.U. 300,00
013.1420WO.001.84	4000K / 3150Lm / 30W	1420mm	BR/White	P.U. 190,00	013.2820WO.001.84	4000K / 6300Lm / 55W	2820mm	BR/White	P.U. 300,00
013.1420ACO.001.84	4000K / 3150Lm / 30W	1420mm	Acet. Nat./ Nat. Satin	P.U. 190,00	013.2820ACO.001.84	4000K / 6300Lm / 55W	2820mm	Acet. Nat./Anodized	P.U. 300,00
013.1420WO.001.54	5700K / 3250Lm / 30W	1420mm	BR/White	P.U. 190,00	013.2820WO.001.54	5700K / 6500Lm / 55W	2820mm	BR/White	P.U. 300,00
013.1420ACO.001.54	5700K / 3250Lm / 30W	1420mm	Acet. Nat./Anodized	P.U. 190,00	013.2820ACO.001.54	5700K / 6500Lm / 55W	2820mm	Acet. Nat./Anodized	P.U. 300,00
013.1700WO.001.82	2700K / 3700Lm / 35W	1700mm	BR/White	P.U. 215,00					
013.1700ACO.001.82	2700K / 3700Lm / 35W	1700mm	Acet. Nat./ Nat. Satin	P.U. 215,00					
013.1700WO.001.84	4000K / 3800Lm / 35W	1700mm	BR/White	P.U. 215,00					
013.1700ACO.001.84	4000K / 3800Lm / 35W	1700mm	Acet. Nat./ Nat. Satin	P.U. 215,00					
013.1700WO.001.54	5700K / 3900Lm / 35W	1700mm	BR/White	P.U. 215,00					
013.1700ACO.001.54	5700K / 3900Lm / 35W	1700mm	Acet. Nat./Anodized	P.U. 215,00					

Opções por Encomenda: Dimensões Específicas (mínimo 56mm) - Kit de Emergência - DALI - Dimável - Sistema de controle de Iluminação ( lux contol )

Obs: Não ligar com Sensores

Devido à constante evolução deste tipo de produtos a marca dos Leds e Drivers assim como as características técnicas podem ser alterados sem aviso prévio, por favor consultar o folheto ou solicitar a ficha técnica atualizada dos artigos pretendidos

## CASAMBI



Luminária em Alumínio Extrudido c/ Barra Led e Driver  
Extruded Aluminium Equipped with Led PCB and Driver

Led: **OSRAM**

Driver: **MW** ou / or **TRIDONIC**

Placa Led 50 000 Horas; 5 Anos Garantia

Led PCB 50 000 Hours; 5 Years Warranty

Eletrificado com barra Led ( **Osram** ) Dupla ( 2 Linhas )  
Assembled with **Osram** Led ( 2 Led Line )

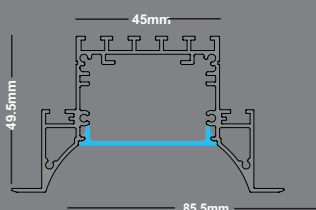

## Rossio 85

Código/Code	Led / Lm / W	L	Cor/Color	€	Código/Code	Led / Lm / W	L	Cor/Color	€
013.0580WO.002.82	2700K / 2450Lm / 25W	580mm	BR/White	P.U. 140,00	013.1980W.O.002.82	2700K / 8550Lm / 75W	1980mm	BR/White	P.U. 330,00
013.0580ACO.002.82	2700K / 2450Lm / 25W	580mm	Acet. Nat. / Nat.Satin	P.U. 140,00	013.1980ACO.002.82	2700K / 8550Lm / 75W	1980mm	Acet. Nat./Anodized	P.U. 330,00
013.0580WO.002.84	4000K / 2550Lm / 25W	580mm	BR/White	P.U. 140,00	013.1980WO.002.84	4000K / 8850Lm / 75W	1980mm	BR/White	P.U. 330,00
013.0580ACO.002.84	4000K / 2550Lm / 25W	580mm	Acet. Nat. / Nat.Satin	P.U. 140,00	013.1980ACO.002.84	4000K / 8850Lm / 75W	1980mm	Acet. Nat./Anodized	P.U. 330,00
013.0580WO.002.54	5700K / 2620Lm / 25W	580mm	BR/White	P.U. 140,00	013.1980WO.002.54	5700K / 9150Lm / 75W	1980mm	BR/White	P.U. 330,00
013.0580ACO.002.54	5700K / 2620Lm / 25W	580mm	Acet. Nat. / Nat.Satin	P.U. 140,00	013.1980ACO.002.54	5700K / 9150Lm / 75W	1980mm	Acet. Nat./Anodized	P.U. 330,00
013.0860WO.002.82	2700K / 3700Lm / 35W	860mm	BR/White	P.U. 160,00	013.2260WO.002.82	2700K / 9750Lm / 90W	2260mm	BR/White	P.U. 355,00
013.0860ACO.002.82	2700K / 3700Lm / 35W	860mm	Acet. Nat. / Nat.Satin	P.U. 160,00	013.2260ACO.002.82	2700K / 9750Lm / 90W	2260mm	Acet. Nat./Anodized	P.U. 355,00
013.0860WO.002.84	4000K / 3800Lm / 35W	860mm	BR/White	P.U. 160,00	013.2260WO.002.84	4000K / 10100Lm / 90W	2260mm	BR/White	P.U. 355,00
013.0860ACO.002.84	4000K / 3800Lm / 35W	860mm	Acet. Nat. / Nat.Satin	P.U. 160,00	013.2260ACO.002.84	4000K / 10100Lm / 90W	2260mm	Acet. Nat./Anodized	P.U. 355,00
013.0860WO.002.54	5700K / 3900Lm / 35W	860mm	BR/White	P.U. 160,00	013.2260WO.002.54	5700K / 10400Lm / 90W	2260mm	BR/White	P.U. 355,00
013.0860ACO.002.54	5700K / 3900Lm / 35W	860mm	Acet. Nat. / Nat.Satin	P.U. 160,00	013.2260ACO.002.54	5700K / 10400Lm / 90W	2260mm	Acet. Nat./Anodized	P.U. 355,00
013.1140WO.002.82	2700K / 4900Lm / 45W	1140mm	BR/White	P.U. 190,00	013.2540WO.002.82	2700K / 11000Lm / 100W	2540mm	BR/White	P.U. 380,00
013.1140ACO.002.82	2700K / 4900Lm / 45W	1140mm	Acet. Nat. / Nat. Satin	P.U. 190,00	013.2540ACO.002.82	2700K / 11000Lm / 100W	2540mm	Acet. Nat./Anodized	P.U. 380,00
013.1140WO.002.84	4000K / 5050Lm / 45W	1140mm	BR/White	P.U. 190,00	013.2540WO.002.84	4000K / 11350Lm / 100W	2540mm	BR/White	P.U. 380,00
013.1140ACO.002.84	4000K / 5050Lm / 45W	1140mm	Acet. Nat. / Nat.Satin	P.U. 190,00	013.2540ACO.002.84	4000K / 11350Lm / 100W	2540mm	Acet. Nat./Anodized	P.U. 380,00
013.1140WO.002.54	5700K / 5200Lm / 45W	1140mm	BR/White	P.U. 190,00	013.2540WO.002.54	5700K / 11700Lm / 100W	2540mm	BR/White	P.U. 380,00
013.1140ACO.002.54	5700K / 5200Lm / 45W	1140mm	Acet. Nat. / Nat. Satin	P.U. 190,00	013.2540ACO.002.54	5700K / 11700Lm / 100W	2540mm	Acet. Nat./Anodized	P.U. 380,00
013.1420WO.002.82	2700K / 6100Lm / 55W	1420mm	BR/White	P.U. 205,00	013.2820WO.002.82	2700K / 12200Lm / 110W	2820mm	BR/White	P.U. 405,00
013.1420ACO.002.82	2700K / 6100Lm / 55W	1420mm	Acet. Nat. / Nat. Satin	P.U. 205,00	013.2820ACO.002.82	2700K / 12200Lm / 110W	2820mm	Acet. Nat./Anodized	P.U. 405,00
013.1420WO.002.84	4000K / 6300Lm / 55W	1420mm	BR/White	P.U. 205,00	013.2820WO.002.84	4000K / 12600Lm / 110W	2820mm	BR/White	P.U. 405,00
013.1420ACO.002.84	4000K / 6300Lm / 55W	1420mm	Acet. Nat. / Nat. Satin	P.U. 205,00	013.2820ACO.002.84	4000K / 12600Lm / 110W	2820mm	Acet. Nat./Anodized	P.U. 405,00
013.1420WO.002.54	5700K / 6500Lm / 55W	1420mm	BR/White	P.U. 205,00	013.2820WO.002.54	5700K / 13050Lm / 110W	2820mm	BR/White	P.U. 405,00
013.1420ACO.002.54	5700K / 6500Lm / 55W	1420mm	Acet. Nat./Anodized	P.U. 205,00	013.2820ACO.002.54	5700K / 13050Lm / 110W	2820mm	Acet. Nat./Anodized	P.U. 405,00
013.1700WO.002.82	2700K / 7300Lm / 65W	1700mm	BR/White	P.U. 230,00					
013.1700ACO.002.82	2700K / 7300Lm / 65W	1700mm	Acet. Nat. / Nat. Satin	P.U. 230,00					
013.1700WO.002.84	4000K / 7600Lm / 65W	1700mm	BR/White	P.U. 230,00					
013.1700ACO.002.84	4000K / 7600Lm / 65W	1700mm	Acet. Nat. / Nat. Satin	P.U. 230,00					
013.1700WO.002.54	5700K / 7850Lm / 65W	1700mm	BR/White	P.U. 230,00					
013.1700ACO.002.54	5700K / 7850Lm / 65W	1700mm	Acet. Nat./Anodized	P.U. 230,00					

**Opções por Encomenda: Dimensões Específicas (mínimo 56mm) - Kit de Emergência - DALI - Dimável - Sistema de controle de Iluminação ( lux contol )**

**Obs: Não ligar com Sensores**

Devido à constante evolução deste tipo de produtos a marca dos Led's e Drivers assim como as características técnicas podem ser alterados sem aviso prévio, por favor consultar o folheto ou solicitar a ficha técnica atualizada dos artigos pretendidos.

Opção Casambi e Dali por Encomenda

## CASAMBI

## DALI 2

Luminária em Alumínio Extrudido c/ Barra Led e Driver  
Extruded Aluminium Equipped with Led PCB and Driver

Led: **OSRAM**

Driver: ou / or

Placa Led 50 000 Horas; 5 Anos Garantia

Led PCB 50 000 Hours; 5 Years Warranty



Eletrificado com barra Led ( Osram ) Simples ( 1 Linha )  
Assembled with Osram Led ( 1 Led Line )

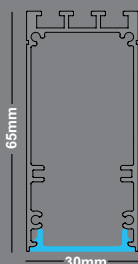

## Areiro 30

Código/Code	Led / Lm / W	L	Cor/Color	€	Código/Code	Led / Lm / W	L	Cor/Color	€
014.0580WO.001.82	2700K / 1220Lm / 15W	580mm	BR/White	P.U. 115,00	014.1700WO.001.82	2700K / 3700Lm / 35W	1700mm	BR/White	P.U. 195,00
014.0580ACO.001.82	2700K / 1220Lm / 15W	580mm	Acet. Nat./ Nat.Satin	P.U. 115,00	014.1700ACO.001.82	2700K / 3700Lm / 35W	1700mm	Acet. Nat./Anodized	P.U. 195,00
014.0580ANO.001.82	2700K / 1220Lm / 15W	580mm	Antr./Dark Grey	P.U. 115,00	014.1700ANO.001.82	2700K / 3700Lm / 35W	1700mm	Antr./Dark Grey	P.U. 195,00
014.0580WO.001.84	4000K / 1300Lm / 15W	580mm	BR/White	P.U. 115,00	014.1700WO.001.84	4000K / 3800Lm / 35W	1700mm	BR/White	P.U. 195,00
014.0580ACO.001.84	4000K / 1300Lm / 15W	580mm	Acet. Nat./ Nat.Satin	P.U. 115,00	014.1700ACO.001.84	4000K / 3800Lm / 35W	1700mm	Acet. Nat./Anodized	P.U. 195,00
014.0580ANO.001.84	4000K / 1300Lm / 15W	580mm	Antr./Dark Grey	P.U. 115,00	014.1700ANO.001.84	4000K / 3800Lm / 35W	1700mm	Antr./Dark Grey	P.U. 195,00
014.0580WO.001.54	5700K / 1350Lm / 15W	580mm	BR/White	P.U. 115,00	014.1700WO.001.54	5700K / 3900Lm / 35W	1700mm	BR/White	P.U. 195,00
014.0580ACO.001.54	5700K / 1350Lm / 15W	580mm	Acet. Nat./ Nat.Satin	P.U. 115,00	014.1700ACO.001.54	5700K / 3900Lm / 35W	1700mm	Acet. Nat./Anodized	P.U. 195,00
014.0580ANO.001.54	5700K / 1350Lm / 15W	580mm	Antr./Dark Grey	P.U. 115,00	014.1700ANO.001.54	5700K / 3900Lm / 35W	1700mm	Antr./Dark Grey	P.U. 195,00
014.0860WO.001.82	2700K / 1850Lm / 20W	860mm	BR/White	P.U. 130,00	014.1980WO.001.82	2700K / 4300Lm / 40W	1980mm	BR/White	P.U. 210,00
014.0860ACO.001.82	2700K / 1850Lm / 20W	860mm	Acet. Nat./ Nat.Satin	P.U. 130,00	014.1980ACO.001.82	2700K / 4300Lm / 40W	1980mm	Acet. Nat./Anodized	P.U. 210,00
014.0860ANO.001.82	2700K / 1850Lm / 20W	860mm	Antr./Dark Grey	P.U. 130,00	014.1980ANO.001.82	2700K / 4300Lm / 40W	1980mm	Antr./Dark Grey	P.U. 210,00
014.0860WO.001.84	4000K / 1900Lm / 20W	860mm	BR/White	P.U. 130,00	014.1980WO.001.84	4000K / 4450Lm / 40W	1980mm	BR/White	P.U. 210,00
014.0860ACO.001.84	4000K / 1900Lm / 20W	860mm	Acet. Nat./ Nat.Satin	P.U. 130,00	014.1980ACO.001.84	4000K / 4450Lm / 40W	1980mm	Acet. Nat./Anodized	P.U. 210,00
014.0860ANO.001.84	4000K / 1900Lm / 20W	860mm	Antr./Dark Grey	P.U. 130,00	014.1980ANO.001.84	4000K / 4450Lm / 40W	1980mm	Antr./Dark Grey	P.U. 210,00
014.0860WO.001.54	5700K / 1900Lm / 20W	860mm	BR/White	P.U. 130,00	014.1980WO.001.54	5700K / 4550Lm / 40W	1980mm	BR/White	P.U. 210,00
014.0860ACO.001.54	5700K / 1900Lm / 20W	860mm	Acet. Nat./ Nat.Satin	P.U. 130,00	014.1980ACO.001.54	5700K / 4550Lm / 40W	1980mm	Acet. Nat./Anodized	P.U. 210,00
014.0860ANO.001.54	5700K / 1900Lm / 20W	860mm	Antr./Dark Grey	P.U. 130,00	014.1980ANO.001.54	5700K / 4550Lm / 40W	1980mm	Antr./Dark Grey	P.U. 210,00
014.1140WO.001.82	2700K / 2450Lm / 25W	1140mm	BR/White	P.U. 160,00	014.2260WO.001.82	2700K / 4900Lm / 45W	2260mm	BR/White	P.U. 230,00
014.1140ACO.001.82	2700K / 2450Lm / 25W	1140mm	Acet. Nat./ Nat. Satin	P.U. 160,00	014.2260ACO.001.82	2700K / 4900Lm / 45W	2260mm	Acet. Nat./Anodized	P.U. 230,00
014.1140ANO.001.82	2700K / 2450Lm / 25W	1140mm	Antr./Dark Grey	P.U. 160,00	014.2260ANO.001.82	2700K / 4900Lm / 45W	2260mm	Antr./Dark Grey	P.U. 230,00
014.1140WO.001.84	4000K / 2550Lm / 25W	1140mm	BR/White	P.U. 160,00	014.2260WO.001.84	4000K / 5050Lm / 45W	2260mm	BR/White	P.U. 230,00
014.1140ACO.001.84	4000K / 2550Lm / 25W	1140mm	Acet. Nat./ Nat.Satin	P.U. 160,00	014.2260ACO.001.84	4000K / 5050Lm / 45W	2260mm	Acet. Nat./Anodized	P.U. 230,00
014.1140ANO.001.84	4000K / 2550Lm / 25W	1140mm	Antr./Dark Grey	P.U. 160,00	014.2260ANO.001.84	4000K / 5050Lm / 45W	2260mm	Antr./Dark Grey	P.U. 230,00
014.1140WO.001.54	5700K / 2650Lm / 25W	1140mm	BR/White	P.U. 160,00	014.2260WO.001.54	5700K / 5200Lm / 45W	2260mm	BR/White	P.U. 230,00
014.1140ACO.001.54	5700K / 2650Lm / 25W	1140mm	Acet. Nat./ Nat. Satin	P.U. 160,00	014.2260ACO.001.54	5700K / 5200Lm / 45W	2260mm	Acet. Nat./Anodized	P.U. 230,00
014.1140ANO.001.54	5700K / 2650Lm / 25W	1140mm	Antr./Dark Grey	P.U. 160,00	014.2260ANO.001.54	5700K / 5200Lm / 45W	2260mm	Antr./Dark Grey	P.U. 230,00
014.1420WO.001.82	2700K / 3050Lm / 30W	1420mm	BR/White	P.U. 175,00	014.2540WO.001.82	2700K / 5500Lm / 50W	2540mm	BR/White	P.U. 215,00
014.1420ACO.001.82	2700K / 3050Lm / 30W	1420mm	Acet. Nat./ Nat. Satin	P.U. 175,00	014.2540ACO.001.82	2700K / 5500Lm / 50W	2540mm	Acet. Nat./Anodized	P.U. 215,00
014.1420ANO.001.82	2700K / 3050Lm / 30W	1420mm	Antr./Dark Grey	P.U. 175,00	014.2540ANO.001.82	2700K / 5500Lm / 50W	2540mm	Antr./Dark Grey	P.U. 215,00
014.1420WO.001.84	4000K / 3150Lm / 30W	1420mm	BR/White	P.U. 175,00	014.2540WO.001.84	4000K / 5700Lm / 50W	2540mm	BR/White	P.U. 215,00
014.1420ACO.001.84	4000K / 3150Lm / 30W	1420mm	Acet. Nat./ Nat. Satin	P.U. 175,00	014.2540ACO.001.84	4000K / 5700Lm / 50W	2540mm	Acet. Nat./Anodized	P.U. 215,00
014.1420ANO.001.84	4000K / 3150Lm / 30W	1420mm	Antr./Dark Grey	P.U. 175,00	014.2540ANO.001.84	4000K / 5700Lm / 50W	2540mm	Antr./Dark Grey	P.U. 215,00
014.1420WO.001.54	5700K / 3250Lm / 30W	1420mm	BR/White	P.U. 175,00	014.2540WO.001.54	5700K / 5900Lm / 50W	2540mm	BR/White	P.U. 215,00
014.1420ACO.001.54	5700K / 3250Lm / 30W	1420mm	Acet. Nat./Anodized	P.U. 175,00	014.2540ACO.001.54	5700K / 5900Lm / 50W	2540mm	Acet. Nat./Anodized	P.U. 215,00
014.1420ANO.001.54	5700K / 3250Lm / 30W	1420mm	Antr./Dark Grey	P.U. 175,00	014.2540ANO.001.54	5700K / 5900Lm / 50W	2540mm	Antr./Dark Grey	P.U. 215,00
014.2820WO.001.82	2700K / 6100Lm / 55W	2820mm	BR/White	P.U. 265,00	014.2820WO.001.82	2700K / 6100Lm / 55W	2820mm	BR/White	P.U. 265,00
014.2820ACO.001.82	2700K / 6100Lm / 55W	2820mm	Acet. Nat./Anodized	P.U. 265,00	014.2820ACO.001.82	2700K / 6100Lm / 55W	2820mm	Acet. Nat./Anodized	P.U. 265,00
014.2820ANO.001.82	2700K / 6100Lm / 55W	2820mm	Antr./Dark Grey	P.U. 265,00	014.2820ANO.001.82	2700K / 6100Lm / 55W	2820mm	Antr./Dark Grey	P.U. 265,00
014.2820WO.001.84	4000K / 6300Lm / 55W	2820mm	BR/White	P.U. 265,00	014.2820WO.001.84	4000K / 6300Lm / 55W	2820mm	BR/White	P.U. 265,00
014.2820ACO.001.84	4000K / 6300Lm / 55W	2820mm	Acet. Nat./Anodized	P.U. 265,00	014.2820ACO.001.84	4000K / 6300Lm / 55W	2820mm	Acet. Nat./Anodized	P.U. 265,00
014.2820ANO.001.84	4000K / 6300Lm / 55W	2820mm	Antr./Dark Grey	P.U. 265,00	014.2820ANO.001.84	4000K / 6300Lm / 55W	2820mm	Antr./Dark Grey	P.U. 265,00
014.2820WO.001.54	5700K / 6500Lm / 55W	2820mm	BR/White	P.U. 265,00	014.2820WO.001.54	5700K / 6500Lm / 55W	2820mm	BR/White	P.U. 265,00
014.2820ACO.001.54	5700K / 6500Lm / 55W	2820mm	Acet. Nat./Anodized	P.U. 265,00	014.2820ACO.001.54	5700K / 6500Lm / 55W	2820mm	Acet. Nat./Anodized	P.U. 265,00
014.2820ANO.001.54	5700K / 6500Lm / 55W	2820mm	Antr./Dark Grey	P.U. 265,00	014.2820ANO.001.54	5700K / 6500Lm / 55W	2820mm	Antr./Dark Grey	P.U. 265,00

Opções por Encomenda: Dimensões Específicas (mínimo 56mm) - Kit de Emergência - DALI - Dimável - Sistema de controle de Iluminação ( lux contol )

Obs: Não ligar com Sensores

Devido à constante evolução deste tipo de produtos a marca dos LEDs e Drivers assim como as características técnicas podem ser alterados sem aviso prévio, por favor consultar o folheto ou solicitar a ficha técnica actualizada dos artigos pretendidos.



Opção Casambi e Dali por Encomenda

CASAMBI



Luminária em Alumínio Extrudido c/ Barra Led e Driver  
Extruded Aluminium Equipped with Led PCB and Driver



Led: OSRAM

Driver: ou / or

Placa Led 50 000 Horas; 5 Anos Garantia

Led PCB 50 000 Hours; 5 Years Warranty

Eletrificado com barra Led ( Osram ) Simples ( 1 Linha )  
Assembled with Osram Led ( 1 Led Line )

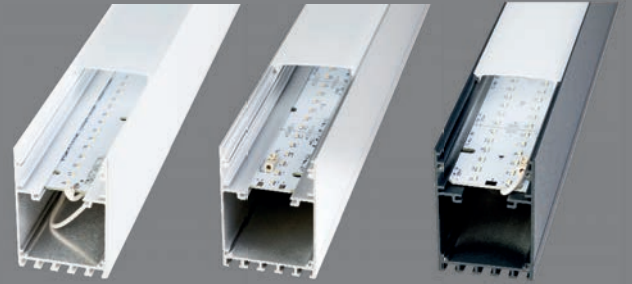
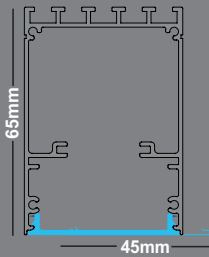

Areiro 45

Código/Code	Led / Lm / W	L	Cor/Color	€	Código/Code	Led / Lm / W	L	Cor/Color	€
015.0580WO.001.82	2700K / 1220Lm / 15W	580mm	BR/White	P.U. 120,00	015.1980WO.001.82	2700K / 4300Lm / 40W	1980mm	BR/White	P.U. 230,00
015.0580ACO.001.82	2700K / 1220Lm / 15W	580mm	Acet. Nat./ Nat.Satin	P.U. 120,00	015.1980ACO.001.82	2700K / 4300Lm / 40W	1980mm	Acet. Nat./Anodized	P.U. 230,00
015.0580ANO.001.82	2700K / 1220Lm / 15W	580mm	Antr./Dark Grey	P.U. 120,00	015.1980ANO.001.82	2700K / 4300Lm / 40W	1980mm	Antr./Dark Grey	P.U. 230,00
015.0580WO.001.84	4000K / 1300Lm / 15W	580mm	BR/White	P.U. 120,00	015.1980WO.001.84	4000K / 4450Lm / 40W	1980mm	BR/White	P.U. 230,00
015.0580ACO.001.84	4000K / 1300Lm / 15W	580mm	Acet. Nat./ Nat.Satin	P.U. 120,00	015.1980ACO.001.84	4000K / 4450Lm / 40W	1980mm	Acet. Nat./Anodized	P.U. 230,00
015.0580ANO.001.84	4000K / 1300Lm / 15W	580mm	Antr./Dark Grey	P.U. 120,00	015.1980ANO.001.84	4000K / 4450Lm / 40W	1980mm	Antr./Dark Grey	P.U. 230,00
015.0580WO.001.54	5700K / 1350Lm / 15W	580mm	BR/White	P.U. 120,00	015.1980WO.001.54	5700K / 4550Lm / 40W	1980mm	BR/White	P.U. 230,00
015.0580ACO.001.54	5700K / 1350Lm / 15W	580mm	Acet. Nat./ Nat.Satin	P.U. 120,00	015.1980ACO.001.54	5700K / 4550Lm / 40W	1980mm	Acet. Nat./Anodized	P.U. 230,00
015.0580ANO.001.54	5700K / 1350Lm / 15W	580mm	Antr./Dark Grey	P.U. 120,00	015.1980ANO.001.54	5700K / 4550Lm / 40W	1980mm	Antr./Dark Grey	P.U. 230,00
015.0860WO.001.82	2700K / 1850Lm / 20W	860mm	BR/White	P.U. 140,00	015.2260WO.001.82	2700K / 4900Lm / 45W	2260mm	BR/White	P.U. 250,00
015.0860ACO.001.82	2700K / 1850Lm / 20W	860mm	Acet. Nat./ Nat.Satin	P.U. 140,00	015.2260ACO.001.82	2700K / 4900Lm / 45W	2260mm	Acet. Nat./Anodized	P.U. 250,00
015.0860ANO.001.82	2700K / 1850Lm / 20W	860mm	Antr./Dark Grey	P.U. 140,00	015.2260ANO.001.82	2700K / 4900Lm / 45W	2260mm	Antr./Dark Grey	P.U. 250,00
015.0860WO.001.84	4000K / 1900Lm / 20W	860mm	BR/White	P.U. 140,00	015.2260WO.001.84	4000K / 5050Lm / 45W	2260mm	BR/White	P.U. 250,00
015.0860ACO.001.84	4000K / 1900Lm / 20W	860mm	Acet. Nat./ Nat.Satin	P.U. 140,00	015.2260ACO.001.84	4000K / 5050Lm / 45W	2260mm	Acet. Nat./Anodized	P.U. 250,00
015.0860ANO.001.84	4000K / 1900Lm / 20W	860mm	Antr./Dark Grey	P.U. 140,00	015.2260ANO.001.84	4000K / 5050Lm / 45W	2260mm	Antr./Dark Grey	P.U. 250,00
015.0860WO.001.54	5700K / 1950Lm / 20W	860mm	BR/White	P.U. 140,00	015.2260WO.001.54	5700K / 5200Lm / 45W	2260mm	BR/White	P.U. 250,00
015.0860ACO.001.54	5700K / 1950Lm / 20W	860mm	Acet. Nat./ Nat.Satin	P.U. 140,00	015.2260ACO.001.54	5700K / 5200Lm / 45W	2260mm	Acet. Nat./Anodized	P.U. 250,00
015.0860ANO.001.54	5700K / 1950Lm / 20W	860mm	Antr./Dark Grey	P.U. 140,00	015.2260ANO.001.54	5700K / 5200Lm / 45W	2260mm	Antr./Dark Grey	P.U. 250,00
015.1140WO.001.82	2700K / 2450Lm / 25W	1140mm	BR/White	P.U. 170,00	015.2540WO.001.82	2700K / 5500Lm / 50W	2540mm	BR/White	P.U. 270,00
015.1140ACO.001.82	2700K / 2450Lm / 25W	1140mm	Acet. Nat./ Nat. Satin	P.U. 170,00	015.2540ACO.001.82	2700K / 5500Lm / 50W	2540mm	Acet. Nat./Anodized	P.U. 270,00
015.1140ANO.001.82	2700K / 2450Lm / 25W	1140mm	Antr./Dark Grey	P.U. 170,00	015.2540ANO.001.82	2700K / 5500Lm / 50W	2540mm	Antr./Dark Grey	P.U. 270,00
015.1140WO.001.84	4000K / 2550Lm / 25W	1140mm	BR/White	P.U. 170,00	015.2540WO.001.84	4000K / 5700Lm / 50W	2540mm	BR/White	P.U. 270,00
015.1140ACO.001.84	4000K / 2550Lm / 25W	1140mm	Acet. Nat./ Nat.Satin	P.U. 170,00	015.2540ACO.001.84	4000K / 5700Lm / 50W	2540mm	Acet. Nat./Anodized	P.U. 270,00
015.1140ANO.001.84	4000K / 2550Lm / 25W	1140mm	Antr./Dark Grey	P.U. 170,00	015.2540ANO.001.84	4000K / 5700Lm / 50W	2540mm	Antr./Dark Grey	P.U. 270,00
015.1140WO.001.54	5700K / 2650Lm / 25W	1140mm	BR/White	P.U. 170,00	015.2540WO.001.54	5700K / 5900Lm / 50W	2540mm	BR/White	P.U. 270,00
015.1140ACO.001.54	5700K / 2650Lm / 25W	1140mm	Acet. Nat./ Nat. Satin	P.U. 170,00	015.2540ACO.001.54	5700K / 5900Lm / 50W	2540mm	Acet. Nat./Anodized	P.U. 270,00
015.1140ANO.001.54	5700K / 2650Lm / 25W	1140mm	Antr./Dark Grey	P.U. 170,00	015.2540ANO.001.54	5700K / 5900Lm / 50W	2540mm	Antr./Dark Grey	P.U. 270,00
015.1420WO.001.82	2700K / 3050Lm / 30W	1420mm	BR/White	P.U. 185,00	015.2820WO.001.82	2700K / 6100Lm / 55W	2820mm	BR/White	P.U. 290,00
015.1420ACO.001.82	2700K / 3050Lm / 30W	1420mm	Acet. Nat./ Nat. Satin	P.U. 185,00	015.2820ACO.001.82	2700K / 6100Lm / 55W	2820mm	Acet. Nat./Anodized	P.U. 290,00
015.1420ANO.001.82	2700K / 3050Lm / 30W	1420mm	Antr./Dark Grey	P.U. 185,00	015.2820ANO.001.82	2700K / 6100Lm / 55W	2820mm	Antr./Dark Grey	P.U. 290,00
015.1420WO.001.84	4000K / 3150Lm / 30W	1420mm	BR/White	P.U. 185,00	015.2820WO.001.84	4000K / 6300Lm / 55W	2820mm	BR/White	P.U. 290,00
015.1420ACO.001.84	4000K / 3150Lm / 30W	1420mm	Acet. Nat./ Nat. Satin	P.U. 185,00	015.2820ACO.001.84	4000K / 6300Lm / 55W	2820mm	Acet. Nat./Anodized	P.U. 290,00
015.1420ANO.001.84	4000K / 3150Lm / 30W	1420mm	Antr./Dark Grey	P.U. 185,00	015.2820ANO.001.84	4000K / 6300Lm / 55W	2820mm	Antr./Dark Grey	P.U. 290,00
015.1420WO.001.54	5700K / 3250Lm / 30W	1420mm	BR/White	P.U. 185,00	015.2820WO.001.54	5700K / 6500Lm / 55W	2820mm	BR/White	P.U. 290,00
015.1420ACO.001.54	5700K / 3250Lm / 30W	1420mm	Acet. Nat./Anodized	P.U. 185,00	015.2820ACO.001.54	5700K / 6500Lm / 55W	2820mm	Acet. Nat./Anodized	P.U. 290,00
015.1420ANO.001.54	5700K / 3250Lm / 30W	1420mm	Antr./Dark Grey	P.U. 185,00	015.2820ANO.001.54	5700K / 6500Lm / 55W	2820mm	Antr./Dark Grey	P.U. 290,00
015.1700WO.001.82	2700K / 3700Lm / 35W	1700mm	BR/White	P.U. 210,00					
015.1700ACO.001.82	2700K / 3700Lm / 35W	1700mm	Acet. Nat./ Nat. Satin	P.U. 210,00					
015.1700ANO.001.82	2700K / 3700Lm / 35W	1700mm	Antr./Dark Grey	P.U. 210,00					
015.1700WO.001.84	4000K / 3800Lm / 35W	1700mm	BR/White	P.U. 210,00					
015.1700ACO.001.84	4000K / 3800Lm / 35W	1700mm	Acet. Nat./ Nat. Satin	P.U. 210,00					
015.1700ANO.001.84	4000K / 3800Lm / 35W	1700mm	Antr./Dark Grey	P.U. 210,00					
015.1700WO.001.54	5700K / 3900Lm / 35W	1700mm	BR/White	P.U. 210,00					
015.1700ACO.001.54	5700K / 3900Lm / 35W	1700mm	Acet. Nat./Anodized	P.U. 210,00					
015.1700ANO.001.54	5700K / 3900Lm / 35W	1700mm	Antr./Dark Grey	P.U. 210,00					

Opções por Encomenda: Dimensões Específicas (mínimo 56mm) - Kit de Emergência - DALI - Dimável - Sistema de controle de Iluminação ( lux contol )

Obs: Não ligar com Sensores

Devido à constante evolução deste tipo de produtos a marca dos Led's e Drivers assim como as características técnicas podem ser alterados sem aviso prévio, por favor consultar o folheto ou solicitar a ficha técnica atualizada dos artigos preferidos.

# CASAMBI



Luminária em Alumínio Extrudido c/ Barra Led e Driver  
Extruded Aluminium Equipped with Led PCB and Driver



Led: **OSRAM**

Driver: **AMW** ou / or **TRIDONIC**

Placa Led 50 000 Horas; 5 Anos Garantia

Led PCB 50 000 Hours; 5 Years Warranty

Eletrificado com barra Led ( **Osram** ) Dupla ( 2 Linhas )  
Assembled with **Osram** Led ( 2 Led Line )

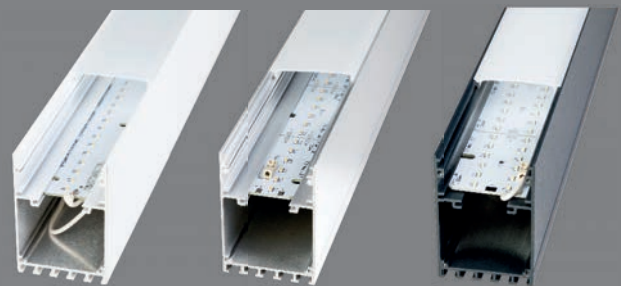
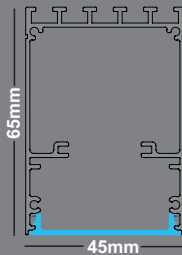

## Areerio 45

Código/Code	Led / Lm / W	L	Cor/Color	€	Código/Code	Led / Lm / W	L	Cor/Color	€
015.0580WO.002.82	2700K / 2450Lm / 25W	580mm	BR/White	P.U. 135,00	015.1980WO.002.82	2700K / 8550Lm / 75W	1980mm	BR/White	P.U. 320,00
015.0580ACO.002.82	2700K / 2450Lm / 25W	580mm	Acet. Nat./ Nat.Satin	P.U. 135,00	015.1980ACO.002.82	2700K / 8550Lm / 75W	1980mm	Acet. Nat./Anodized	P.U. 320,00
015.0580ANO.002.82	2700K / 2450Lm / 25W	580mm	Antr./Dark Grey	P.U. 135,00	015.1980ANO.002.82	2700K / 8550Lm / 75W	1980mm	Antr./Dark Grey	P.U. 320,00
015.0580WO.002.84	4000K / 2550Lm / 25W	580mm	BR/White	P.U. 135,00	015.1980WO.002.84	4000K / 8850Lm / 75W	1980mm	BR/White	P.U. 320,00
015.0580ACO.002.84	4000K / 2550Lm / 25W	580mm	Acet. Nat./ Nat.Satin	P.U. 135,00	015.1980ACO.002.84	4000K / 8850Lm / 75W	1980mm	Acet. Nat./Anodized	P.U. 320,00
015.0580ANO.002.84	4000K / 2550Lm / 25W	580mm	Antr./Dark Grey	P.U. 135,00	015.1980ANO.002.84	4000K / 8850Lm / 75W	1980mm	Antr./Dark Grey	P.U. 320,00
015.0580WO.002.54	5700K / 2620Lm / 25W	580mm	BR/White	P.U. 135,00	015.1980WO.002.54	5700K / 9150Lm / 75W	1980mm	BR/White	P.U. 320,00
015.0580ACO.002.54	5700K / 2620Lm / 25W	580mm	Acet. Nat./ Nat.Satin	P.U. 135,00	015.1980ACO.002.54	5700K / 9150Lm / 75W	1980mm	Acet. Nat./Anodized	P.U. 320,00
015.0580ANO.002.54	5700K / 2620Lm / 25W	580mm	Antr./Dark Grey	P.U. 135,00	015.1980ANO.002.54	5700K / 9150Lm / 75W	1980mm	Antr./Dark Grey	P.U. 320,00
015.0860WO.002.82	2700K / 3700Lm / 35W	860mm	BR/White	P.U. 155,00	015.2260WO.002.82	2700K / 9750Lm / 90W	2260mm	BR/White	P.U. 350,00
015.0860ACO.002.82	2700K / 3700Lm / 35W	860mm	Acet. Nat./ Nat.Satin	P.U. 155,00	015.2260ACO.002.82	2700K / 9750Lm / 90W	2260mm	Acet. Nat./Anodized	P.U. 350,00
015.0860ANO.002.82	2700K / 3700Lm / 35W	860mm	Antr./Dark Grey	P.U. 155,00	015.2260ANO.002.82	2700K / 9750Lm / 90W	2260mm	Antr./Dark Grey	P.U. 350,00
015.0860WO.002.84	4000K / 3800Lm / 35W	860mm	BR/White	P.U. 155,00	015.2260WO.002.84	4000K / 10100Lm / 90W	2260mm	BR/White	P.U. 350,00
015.0860ACO.002.84	4000K / 3800Lm / 35W	860mm	Acet. Nat./ Nat.Satin	P.U. 155,00	015.2260ACO.002.84	4000K / 10100Lm / 90W	2260mm	Acet. Nat./Anodized	P.U. 350,00
015.0860ANO.002.84	4000K / 3800Lm / 35W	860mm	Antr./Dark Grey	P.U. 155,00	015.2260ANO.002.84	4000K / 10100Lm / 90W	2260mm	Antr./Dark Grey	P.U. 350,00
015.0860WO.002.54	5700K / 3900Lm / 35W	860mm	BR/White	P.U. 155,00	015.2260WO.002.54	5700K / 10400Lm / 90W	2260mm	BR/White	P.U. 350,00
015.0860ACO.002.54	5700K / 3900Lm / 35W	860mm	Acet. Nat./ Nat.Satin	P.U. 155,00	015.2260ACO.002.54	5700K / 10400Lm / 90W	2260mm	Acet. Nat./Anodized	P.U. 350,00
015.0860ANO.002.54	5700K / 3900Lm / 35W	860mm	Antr./Dark Grey	P.U. 155,00	015.2260ANO.002.54	5700K / 10400Lm / 90W	2260mm	Antr./Dark Grey	P.U. 350,00
015.1140WO.002.82	2700K / 4900Lm / 45W	1140mm	BR/White	P.U. 185,00	015.2540WO.002.82	2700K / 11000Lm / 100W	2540mm	BR/White	P.U. 370,00
015.1140ACO.002.82	2700K / 4900Lm / 45W	1140mm	Acet. Nat./ Nat. Satin	P.U. 185,00	015.2540ACO.002.82	2700K / 11000Lm / 100W	2540mm	Acet. Nat./Anodized	P.U. 370,00
015.1140ANO.002.82	2700K / 4900Lm / 45W	1140mm	Antr./Dark Grey	P.U. 185,00	015.2540ANO.002.82	2700K / 11000Lm / 100W	2540mm	Antr./Dark Grey	P.U. 370,00
015.1140WO.002.84	4000K / 5050Lm / 45W	1140mm	BR/White	P.U. 185,00	015.2540WO.002.84	4000K / 11350Lm / 100W	2540mm	BR/White	P.U. 370,00
015.1140ACO.002.84	4000K / 5050Lm / 45W	1140mm	Acet. Nat./ Nat.Satin	P.U. 185,00	015.2540ACO.002.84	4000K / 11350Lm / 100W	2540mm	Acet. Nat./Anodized	P.U. 370,00
015.1140ANO.002.84	4000K / 5050Lm / 45W	1140mm	Antr./Dark Grey	P.U. 185,00	015.2540ANO.002.84	4000K / 11350Lm / 100W	2540mm	Antr./Dark Grey	P.U. 370,00
015.1140WO.002.54	5700K / 5200Lm / 45W	1140mm	BR/White	P.U. 185,00	015.2540WO.002.54	5700K / 11700Lm / 100W	2540mm	BR/White	P.U. 370,00
015.1140ACO.002.54	5700K / 5200Lm / 45W	1140mm	Acet. Nat./ Nat. Satin	P.U. 185,00	015.2540ACO.002.54	5700K / 11700Lm / 100W	2540mm	Acet. Nat./Anodized	P.U. 370,00
015.1140ANO.002.54	5700K / 5200Lm / 45W	1140mm	Antr./Dark Grey	P.U. 185,00	015.2540ANO.002.54	5700K / 11700Lm / 100W	2540mm	Antr./Dark Grey	P.U. 370,00
015.1420WO.002.82	2700K / 6100Lm / 55W	1420mm	BR/White	P.U. 200,00	015.2820WO.002.82	2700K / 12200Lm / 110W	2820mm	BR/White	P.U. 390,00
015.1420ACO.002.82	2700K / 6100Lm / 55W	1420mm	Acet. Nat./ Nat. Satin	P.U. 200,00	015.2820ACO.002.82	2700K / 12200Lm / 110W	2820mm	Acet. Nat./Anodized	P.U. 390,00
015.1420ANO.002.82	2700K / 6100Lm / 55W	1420mm	Antr./Dark Grey	P.U. 200,00	015.2820ANO.002.82	2700K / 12200Lm / 110W	2820mm	Antr./Dark Grey	P.U. 390,00
015.1420WO.002.84	4000K / 6300Lm / 55W	1420mm	BR/White	P.U. 200,00	015.2820WO.002.84	4000K / 12600Lm / 110W	2820mm	BR/White	P.U. 390,00
015.1420ACO.002.84	4000K / 6300Lm / 55W	1420mm	Acet. Nat./ Nat. Satin	P.U. 200,00	015.2820ACO.002.84	4000K / 12600Lm / 110W	2820mm	Acet. Nat./Anodized	P.U. 390,00
015.1420ANO.002.84	4000K / 6300Lm / 55W	1420mm	Antr./Dark Grey	P.U. 200,00	015.2820ANO.002.84	4000K / 12600Lm / 110W	2820mm	Antr./Dark Grey	P.U. 390,00
015.1420WO.002.54	5700K / 6500Lm / 55W	1420mm	BR/White	P.U. 200,00	015.2820WO.002.54	5700K / 13050Lm / 110W	2820mm	BR/White	P.U. 390,00
015.1420ACO.002.54	5700K / 6500Lm / 55W	1420mm	Acet. Nat./Anodized	P.U. 200,00	015.2820ACO.002.54	5700K / 13050Lm / 110W	2820mm	Acet. Nat./Anodized	P.U. 390,00
015.1420ANO.002.54	5700K / 6500Lm / 55W	1420mm	Antr./Dark Grey	P.U. 200,00	015.2820ANO.002.54	5700K / 13050Lm / 110W	2820mm	Antr./Dark Grey	P.U. 390,00
015.1700WO.002.82	2700K / 7300Lm / 65W	1700mm	BR/White	P.U. 225,00					
015.1700ACO.002.82	2700K / 7300Lm / 65W	1700mm	Acet. Nat./ Nat. Satin	P.U. 225,00					
015.1700ANO.002.82	2700K / 7300Lm / 65W	1700mm	Antr./Dark Grey	P.U. 225,00					
015.1700WO.002.84	4000K / 6760Lm / 65W	1700mm	BR/White	P.U. 225,00					
015.1700ACO.002.84	4000K / 7600Lm / 65W	1700mm	Acet. Nat./ Nat. Satin	P.U. 225,00					
015.1700ANO.002.84	4000K / 7600Lm / 65W	1700mm	Antr./Dark Grey	P.U. 225,00					
015.1700WO.002.54	5700K / 7850Lm / 65W	1700mm	BR/White	P.U. 225,00					
015.1700ACO.002.54	5700K / 7850Lm / 65W	1700mm	Acet. Nat./Anodized	P.U. 225,00					
015.1700ANO.002.54	5700K / 7850Lm / 65W	1700mm	Antr./Dark Grey	P.U. 225,00					

**Opções por Encomenda: Dimensões Específicas (mínimo 56mm) - Kit de Emergência - DALI - Dimável - Sistema de controle de Iluminação ( lux contol )**

**Obs: Não ligar com Sensores**

Devido à constante evolução deste tipo de produtos a marca dos Led's e Drivers assim como as características técnicas podem ser alterados sem aviso prévio, por favor consultar o folheto ou solicitar a ficha técnica atualizada dos artigos pretendidos.



Opção Casambi e Dali por Encomenda

## CASAMBI



Luminária em Alumínio Extrudido c/ Barra Led e Driver  
Extruded Aluminium Equipped with Led PCB and Driver

Led: **OSRAM**

Driver: **AMW** ou / or **TRIDONIC**

Placa Led 50 000 Horas; 5 Anos Garantia

Led PCB 50 000 Hours; 5 Years Warranty

Eletrificado com 2 fitas Led  
Assembled with 2 Led Strip

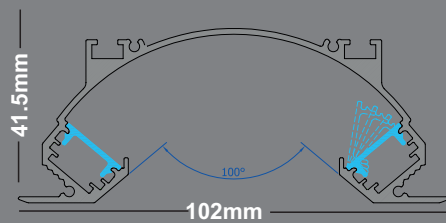

## Oriente 102

Código/Code	Led / Lm / W	L	Cor/Color	€	Código/Code	Led / Lm / W	L	Cor/Color	€
019.0520WO.003.82	2700K / 1500Lm / 11W	520mm	BR/White	P.U. 195,00	019.1020WO.003.82	2700K / 3000Lm / 21W	1020mm	BR/White	P.U. 266,00
019.0520ACO.003.82	2700K / 1500Lm / 11W	520mm	Acet. Nat./ Nat.Satin	P.U. 195,00	019.1020ACO.003.82	2700K / 3000Lm / 21W	1020mm	Acet. Nat./Anodized	P.U. 266,00
019.0520WO.003.84	4000K / 1500Lm / 11W	520mm	BR/White	P.U. 195,00	019.1020WO.003.84	4000K / 3000Lm / 21W	1020mm	BR/White	P.U. 266,00
019.0520ACO.003.84	4000K / 1500Lm / 11W	520mm	Acet. Nat./ Nat.Satin	P.U. 195,00	019.1020ACO.003.84	4000K / 3000Lm / 21W	1020mm	Acet. Nat./Anodized	P.U. 266,00
019.0520WO.003.54	5700K / 1500Lm / 11W	520mm	BR/White	P.U. 195,00	019.1020WO.003.54	5700K / 3000Lm / 21W	1020mm	BR/White	P.U. 266,00
019.0520ACO.003.54	5700K / 1500Lm / 11W	520mm	Acet. Nat./ Nat.Satin	P.U. 195,00	019.1020ACO.003.54	5700K / 3000Lm / 21W	1020mm	Acet. Nat./Anodized	P.U. 266,00
019.1520WO.003.82	2700K / 4500Lm / 35W	1520mm	BR/White	P.U. 290,00	019.2520WO.003.82	2700K / 7500Lm / 55W	2520mm	BR/White	P.U. 538,00
019.1520ACO.003.82	2700K / 4500Lm / 35W	1520mm	Acet. Nat./ Nat. Satin	P.U. 290,00	019.2520ACO.003.82	2700K / 7500Lm / 55W	2520mm	Acet. Nat./Anodized	P.U. 538,00
019.1520WO.003.84	4000K / 4500Lm / 35W	1520mm	BR/White	P.U. 290,00	019.2520WO.003.84	4000K / 7500Lm / 55W	2520mm	BR/White	P.U. 538,00
019.1520ACO.003.84	4000K / 4500Lm / 35W	1520mm	Acet. Nat./ Nat.Satin	P.U. 290,00	019.2520ACO.003.84	4000K / 7500Lm / 55W	2520mm	Acet. Nat./Anodized	P.U. 538,00
019.1520WO.003.54	5700K / 4500Lm / 35W	1520mm	BR/White	P.U. 290,00	019.2520WO.003.54	5700K / 7500Lm / 55W	2520mm	BR/White	P.U. 538,00
019.1520ACO.003.54	5700K / 4500Lm / 35W	1520mm	Acet. Nat./ Nat. Satin	P.U. 290,00	019.2520ACO.003.54	5700K / 7500Lm / 55W	2520mm	Acet. Nat./Anodized	P.U. 538,00
019.2020WO.003.82	2700K / 6000Lm / 45W	2020mm	BR/White	P.U. 416,00	019.3020WO.003.82	2700K / 9000Lm / 65W	3020mm	BR/White	P.U. 575,00
019.2020ACO.003.82	2700K / 6000Lm / 45W	2020mm	Acet. Nat./ Nat. Satin	P.U. 416,00	019.3020ACO.003.82	2700K / 9000Lm / 65W	3020mm	Acet. Nat./Anodized	P.U. 575,00
019.2020WO.003.84	4000K / 6000Lm / 45W	2020mm	BR/White	P.U. 416,00	019.3020WO.003.84	4000K / 9000Lm / 65W	3020mm	BR/White	P.U. 575,00
019.2020ACO.003084	4000K / 6000Lm / 45W	2020mm	Acet. Nat./ Nat. Satin	P.U. 416,00	019.3020ACO.003.84	4000K / 9000Lm / 65W	3020mm	Acet. Nat./Anodized	P.U. 575,00
019.2020WO.003054	5700K / 6000Lm / 45W	2020mm	BR/White	P.U. 416,00	019.3020WO.003.54	5700K / 9000Lm / 65W	3020mm	BR/White	P.U. 575,00
019.2020ACO.003054	5700K / 6000Lm / 45W	2020mm	Acet. Nat./Anodized Antr./Dark Grey	P.U. 416,00	019.3020ACO.003.54	5700K / 9000Lm / 65W	3020mm	Acet. Nat./Anodized	P.U. 575,00

Opções por Encomenda: Dimensões Específicas (mínimo 56mm) - Kit de Emergência - DALI - Dimável - Sistema de controle de Iluminação ( lux contol )

Obs: Não ligar com Sensores

Devido à constante evolução deste tipo de produtos a marca dos Leds e Drivers assim como as características técnicas podem ser alterados sem aviso prévio, por favor consultar o folheto ou solicitar a ficha técnica actualizada dos artigos pretendidos.



### SL-E1315B

Bloco 3 Tomadas Schuko  
Com Alvéolos Protegidos  
Branco - 1,5 mts  
Cabo H05VV-F 3G1,5  
10/16A - 250Vac - 3680W  
Quantidade Caixa: 40 pcs  
**P.U. 7,50€**



### SL-E1415B

Bloco 4 Tomadas Schuko  
Com Alvéolos Protegidos  
Branco - 1,5 mts  
Cabo H05VV-F 3G1,5  
10/16A - 250Vac - 3680W  
Quantidade Caixa: 40 pcs  
**P.U. 9,00€**



### SL-E1515B

Bloco 5 Tomadas Schuko  
Com Alvéolo Protegidos  
Branco - 1,5 mts  
Cabo H05VV-F 3G1,5  
10/16A - 250Vac - 3680W  
Quantidade Caixa: 40 pcs  
**P.U. 10,10€**



### SL-E1615B

Bloco 6 Tomadas Schuko  
Com Alvéolos Protegidos  
Branco - 1,5 mts  
Cabo H05VV-F 3G1,5  
10/16A - 250Vac - 3680W  
Quantidade Caixa: 40 pcs  
**P.U. 10,90€**

### SL-E1330B

Bloco 3 Tomadas Schuko  
Com Alvéolos Protegidos  
Branco - 3 mts  
Cabo H05VV-F 3G1,5  
10/16A - 250Vac - 3680W  
Quantidade Caixa: 30 pcs  
**P.U. 10,80€**

### SL-E1430B

Bloco 4 Tomadas Schuko  
Com Alvéolos Protegidos  
Branco - 3 mts  
Cabo H05VV-F 3G1,5  
10/16A - 250Vac - 3680W  
Quantidade Caixa: 30 pcs  
**P.U. 12,85€**

### SL-E1530B

Bloco 5 Tomadas Schuko  
Com Alvéolo Protegidos  
Branco - 3 mts  
Cabo H05VV-F 3G1,5  
10/16A - 250Vac - 3680W  
Quantidade Caixa: 30 pcs  
**P.U. 14,20€**

### SL-E1630B

Bloco 6 Tomadas Schuko  
Com Alvéolos Protegidos  
Branco - 3 mts  
Cabo H05VV-F 3G1,5  
10/16A - 250Vac - 3680W  
Quantidade Caixa: 30 pcs  
**P.U. 14,10€**

### SL-E1350B

Bloco 3 Tomadas Schuko  
Com Alvéolos Protegidos  
Branco - 5 mts  
Cabo H05VV-F 3G1,5  
10/16A - 250Vac - 3680W  
Quantidade Caixa: 20 pcs  
**P.U. 15,70€**

### SL-E1450B

Bloco 4 Tomadas Schuko  
Com Alvéolos Protegidos  
Branco - 5 mts  
Cabo H05VV-F 3G1,5  
10/16A - 250Vac - 3680W  
Quantidade Caixa: 20 pcs  
**P.U. 18,00€**

### SL-E1550B

Bloco 5 Tomadas Schuko  
Com Alvéolo Protegidos  
Branco - 5 mts  
Cabo H05VV-F 3G1,5  
10/16A - 250Vac - 3680W  
Quantidade Caixa: 20 pcs  
**P.U. 17,70€**

### SL-E1650B

Bloco 6 Tomadas Schuko  
Com Alvéolos Protegidos  
Branco - 5 mts  
Cabo H05VV-F 3G1,5  
10/16A - 250Vac - 3680W  
Quantidade Caixa: 20 pcs  
**P.U. 18,85€**



### SL-E2315B

Bloco 3 Tomadas Schuko  
Com Alvéolos Protegidos  
Com Interruptor  
Branco - 1,5 mts  
Cabo H05VV-F 3G1,5  
10/16A - 250Vac - 3680W  
Quantidade Caixa: 40 pcs  
**P.U. 8,35€**



### SL-E2415B

Bloco 4 Tomadas Schuko  
Com Alvéolos Protegidos  
Com Interruptor  
Branco - 1,5 mts  
Cabo H05VV-F 3G1,5  
10/16A - 250Vac - 3680W  
Quantidade Caixa: 40 pcs  
**P.U. 9,50€**



### SL-E2515B

Bloco 5 Tomadas Schuko  
Com Alvéolo Protegidos  
Com Interruptor  
Branco - 1,5 mts  
Cabo H05VV-F 3G1,5  
10/16A - 250Vac - 3680W  
Quantidade Caixa: 40 pcs  
**P.U. 10,80€**



### SL-E2615B

Bloco 6 Tomadas Schuko  
Com Alvéolos Protegidos  
Com Interruptor  
Branco - 1,5 mts  
Cabo H05VV-F 3G1,5  
10/16A - 250Vac - 3680W  
Quantidade Caixa: 40 pcs  
**P.U. 11,50€**

### SL-E2330B

Bloco 3 Tomadas Schuko  
Com Alvéolos Protegidos  
Com Interruptor  
Branco - 3 mts  
Cabo H05VV-F 3G1,5  
10/16A - 250Vac - 3680W  
Quantidade Caixa: 30 pcs  
**P.U. 11,65€**

### SL-E2430B

Bloco 4 Tomadas Schuko  
Com Alvéolos Protegidos  
Com Interruptor  
Branco - 3 mts  
Cabo H05VV-F 3G1,5  
10/16A - 250Vac - 3680W  
Quantidade Caixa: 30 pcs  
**P.U. 13,50€**

### SL-E2530B

Bloco 5 Tomadas Schuko  
Com Alvéolo Protegidos  
Com Interruptor  
Branco - 3 mts  
Cabo H05VV-F 3G1,5  
10/16A - 250Vac - 3680W  
Quantidade Caixa: 20 pcs  
**P.U. 13,80€**

### SL-E2630B

Bloco 6 Tomadas Schuko  
Com Alvéolos Protegidos  
Com Interruptor  
Branco - 3 mts  
Cabo H05VV-F 3G1,5  
10/16A - 250Vac - 3680W  
Quantidade Caixa: 30 pcs  
**P.U. 14,30€**

### SL-E2350B

Bloco 3 Tomadas Schuko  
Com Alvéolos Protegidos  
Com Interruptor  
Branco - 5 mts  
Cabo H05VV-F 3G1,5  
10/16A - 250Vac - 3680W  
Quantidade Caixa: 20 pcs  
**P.U. 17,00€**

### SL-E2450B

Bloco 4 Tomadas Schuko  
Com Alvéolos Protegidos  
Com Interruptor  
Branco - 5 mts  
Cabo H05VV-F 3G1,5  
10/16A - 250Vac - 3680W  
Quantidade Caixa: 20 pcs  
**P.U. 18,00€**

### SL-E2550B

Bloco 5 Tomadas Schuko  
Com Alvéolo Protegidos  
Com Interruptor  
Branco - 5 mts  
Cabo H05VV-F 3G1,5  
10/16A - 250Vac - 3680W  
Quantidade Caixa: 20 pcs  
**P.U. 18,65€**

### SL-E2650B

Bloco 6 Tomadas Schuko  
Com Alvéolos Protegidos  
Com Interruptor  
Branco - 5 mts  
Cabo H05VV-F 3G1,5  
10/16A - 250Vac - 3680W  
Quantidade Caixa: 20 pcs  
**P.U. 19,30€**

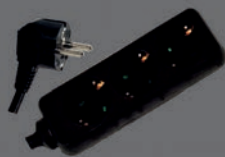

**SL-E1315P**

Bloco 3 Tomadas Schuko  
Com Alvéolos Protegidos  
Preto - 1,5 mts  
Cabo H05VV-F 3G1,5  
10/16A - 250Vac - 3680W  
Quantidade Caixa: 40 pcs  
**P.U. 7,55€**



**SL-E1615P**

Bloco 6 Tomadas Schuko  
Com Alvéolos Protegidos  
Preto - 1,5 mts  
Cabo H05VV-F 3G1,5  
10/16A - 250Vac - 3680W  
Quantidade Caixa: 40 pcs  
**P.U. 11,15€**



**SL-E1200B**

Bloco 2 Tomadas Schuko  
Branco - sem Cabo  
10 / 16A - 250Vac - 3680W  
Quantidade Caixa: 200 pcs

**P.U. 3,25€**



**SL-E1300B**

Bloco 3 Tomadas Schuko  
Branco - sem Cabo  
10 / 16A - 250Vac - 3680W  
Quantidade Caixa: 160 pcs

**P.U. 3,60€**

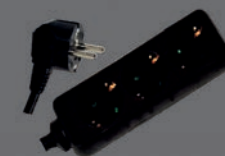

**SL-E1350P**

Bloco 3 Tomadas Schuko  
Com Alvéolos Protegidos  
Preto - 5 mts  
Cabo H05VV-F 3G1,5  
10/16A - 250Vac - 3680W  
quantidade Caixa: 20 pcs  
**P.U. 16,00€**

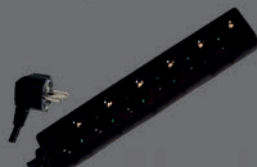

**SL-E1650P**

Bloco 6 Tomadas Schuko  
Com Alvéolos Protegidos  
Preto - 5 mts  
Cabo H05VV-F 3G1,5  
10/16A - 250Vac - 3680W  
Quantidade Caixa: 20 pcs  
**P.U. 19,10€**



**SL-E1400B**

Bloco 4 Tomadas Schuko  
Branco - sem Cabo  
10 / 16A - 250Vac - 3680W  
Quantidade Caixa: 120 pcs

**P.U. 4,65€**



**SL-E1500B**

Bloco 5 Tomadas Schuko  
Branco - sem Cabo  
10 / 16A - 250Vac - 3680W  
Quantidade Caixa: 60 pcs

**P.U. 5,25€**



**SL-E6015B**

Bloco 3 Tomadas Schuko  
Com Alvéolos Protegidos  
Branco - 1,5 mts  
Cabo H05VV-F 3G1.5  
Com Inter. Independentes  
10 / 16A - 250Vac - 3680W

Quant. Caixa: 20 pcs

**P.U. 20,80€**



**SL-E6050B**

Bloco 6 Tomadas Schuko  
Com Alvéolos Protegidos  
Branco - 1,5 mts  
Cabo H05VV-F 3G1.5  
Com Inter. Independentes  
10 / 16A - 250Vac - 3680W

Quant. Caixa: 20 pcs

**P.U. 36,90€**



**SL-E7015B**

Bloco 5 Tomadas Schuko  
Com Alvéolos Protegidos  
Branco - 1,5 mts; C/ Int.  
Cabo H05VV-F 3G1.5  
5 Tom.Schuko 16A  
2 USB, 5VDC, Max.2,1A  
10 / 16A - 250Vac - 3680W

Quant. Caixa: 30 pcs

**P.U. 33,50€**



**SL-E8000B**

Adaptador  
Com Alvéolos Protegidos  
1 tom. Schuko 16A + 2 USB 5Vdc  
2 USB 5Vdc, Max. 2,4A  
Suporte p/ TLM + Lux presença  
Lux presença Aut- < 10lux  
10 / 16A - 110/230Vac 50/60Hz

Quant. Caixa: 50 pcs

**P.U. 21,55€**



**SL-E8014B**

Suporte E14 com Anilha  
Branca - 2A 250Vac  
Quant.Emb./Cx:50/200pcs  
**P.U. 0,77€**

Quantidade Mínima 50 Unid.



**SL-E8027B**

Suporte E27 com Anilha  
Branca - 2A 250Vac  
Quant.Emb./Cx:50/200pcs  
**P.U. 0,88€**

Quantidade Mínima 50 Unid.



**SL-E8114B**

Suporte E14  
Branco - 2A 250Vac  
Quant.Emb./Cx:50/200pcs  
**P.U. 0,49€**

Quantidade Mínima 50 Unid.



**SL-E8127B**

Suporte E27  
Branco - 2A 250Vac  
Quant.Emb./Cx:50/200pcs  
**P.U. 0,74€**

Quantidade Mínima 50 Unid.

**SL-E8014P**

Suporte E14 com Anilha  
Preto - 2A 250Vac  
Quant.Emb./Cx:50/200pcs  
**P.U. 0,77€**

**SL-E8027P**

Suporte E27 com Anilha  
Preto - 2A 250Vac  
Quant.Emb./Cx:50/200pcs  
**P.U. 0,88€**

**SL-E8114P**

Suporte E14  
Preto - 2A 250Vac  
Quant.Emb./Cx:50/200pcs  
**P.U. 0,49€**

**SL-E8127P**

Suporte E27  
Preto - 2A 250Vac  
Quant.Emb./Cx:50/200pcs  
**P.U. 0,74€**





**SL-E4010P**

Enrolador c/4 Tomadas Preto - 10 mts  
Cabo H05VV-F 3G1,5  
10/16A - 250Vac-3680W  
Quant. Caixa: 5 pcs

**P.U. 35,50€**



**SL-E4025P**

Enrolador c/4 Tomadas Preto - 25 mts  
Cabo H05VV-F 3G1,5  
10/16A - 250Vac-3680W  
Quant. Caixa: 1 pcs

**P.U. 71,80€**



**SL-E4050P**

Enrolador c/4 Tomadas Preto - 50 mts  
Cabo H05VV-F 3G1,5  
10/16A - 250Vac-3680W  
Quant. Caixa: 1 pcs

**P.U. 116,50€**



**SL-E4125P**

Enrolador c/4 Tomadas Preto - 25 mts  
Cabo H05VV-F 3G2,5  
10/16A - 250Vac-3680W  
Quant. Caixa: 1 pcs

**P.U. 123,00€**



**SL-E4140P**

Enrolador c/4 Tomadas Preto - 40 mts  
Cabo H05VV-F 3G2,5  
10/16A - 250Vac-3860W  
Quant. Caixa: 1 pcs

**P.U. 181,20€**



**SL-E8040B**

Ficha Fêmea Schuko Branca - 16A 250Vac  
Qt.Emb./Cx:30/300pcs

**P.U. 1,50€**



**SL-E8050B**

Ficha Macho Schuko Branca - 16A 250Vac  
Qt.Emb./Cx.30/300pcs

**P.U. 1,35€**

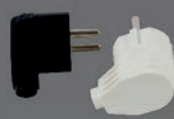

**SL-E8150B**

Fi. Macho Schuko Branca - 16A 250Vac-Saída Lateral  
Qt.Emb./Cx:30/300pcs

**P.U. 1,25€**



**SL-E8060P**

Ficha Macho Schuko Borracha-16A 250Vac  
Qt.Emb./Cx:20/200pcs

**P.U. 1,50€**



**SL-E8073P**

Bloco Triplo em Borracha 16A 250Vac - IP44  
Quant.Emb.:4/40pcs

**P.U. 8,70€**

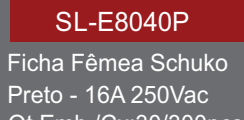

**SL-E8040P**

Ficha Fêmea Schuko Preto - 16A 250Vac  
Qt.Emb./Cx:30/300pcs

**P.U. 1,50€**



**SL-E8050P**

Ficha Macho Schuko Preto - 16A 250Vac  
Qt.Emb./Cx.30/300pcs

**P.U. 1,35€**

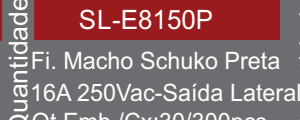

**SL-E8150P**

Fi. Macho Schuko Preta - 16A 250Vac-Saída Lateral  
Qt.Emb./Cx:30/300pcs

**P.U. 1,25€**



**SL-E8070P**

Ficha Fêmea Schuko Borracha-16A 250Vac  
Qt.Emb./Cx:20/300pcs

**P.U. 1,85€**



**SL-E5002T**

Ficha Dupla Schuko 10/16A-250Vac-3500W  
Quant. Caixa: 100 pcs

**P.U. 2,80€**



**SL-E5002L**

Ficha Dupla Schuko 10/16A-250Vac-3500W  
Quant. Caixa: 100 pcs

**P.U. 2,80€**



**SL-E5003T**

Ficha Tripla Schuko 10/16A-250Vac-3500W  
Quant. Caixa: 100 pcs

**P.U. 4,20€**



**SL-E5003L**

Ficha Tripla Schuko 10/16A-250Vac-3500W  
Quant. Caixa: 100 pcs

**P.U. 3,90€**



**SL-E8160P**

Ficha Macho em Borracha Saída Lateral-16A 250Vac IP 44  
Quant.Emb./Cx.20/200pc

**P.U. 2,15€**



**SL-E3003B**

Extens.Macho/Fêmea Branca - 3 mts  
Cabo H05VV-F 3x1,5  
10/16A-250Vac-3680W  
Quant. Caixa: 20 pcs

**P.U. 9,90€**



**SL-E3005B**

Extens.Macho/Fêmea Branca - 5 mts  
Cabo H05VV-F 3G1,5  
10/16A-250Vac-3680W  
Quant. Caixa: 20 pcs

**P.U. 14,60€**



**SL-E3010B**

Extens.Macho/Fêmea Branca - 10 mts  
Cabo H05VV-F 3G1,5  
10/16A-250Vac-3680W  
Quant. Caixa: 10 pcs

**P.U. 23,00€**



**SL-E3015B**

Extens.Macho/Fêmea Branca - 15 mts  
Cabo H05VV-F 3G1,5  
10/16A-250Vac-3680W  
Quant. Caixa: 4 pcs

**P.U. 34,00€**



**SL-E3020B**

Extens.Macho/Fêmea Branca - 20 mts  
Cabo H05VV-F 3G1,5  
10/16A-250Vac-3680W  
Quant. Caixa: 4 pcs

**P.U. 43,10€**



**SL-E3003P**

Extens.Macho/Fêmea Preta - 3 mts  
Cabo H05VV-F 3x1,5  
10/16A-250Vac-3680W  
Quant. Caixa: 20 pcs

**P.U. 9,90€**

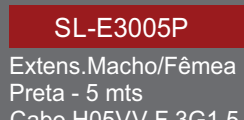

**SL-E3005P**

Extens.Macho/Fêmea Preta - 5 mts  
Cabo H05VV-F 3G1,5  
10/16A-250Vac-3680W  
Quant. Caixa: 20 pcs

**P.U. 14,60€**

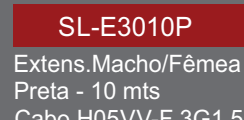

**SL-E3010P**

Extens.Macho/Fêmea Preta - 10 mts  
Cabo H05VV-F 3G1,5  
10/16A-250Vac-3680W  
Quant. Caixa: 10 pcs

**P.U. 23,00€**

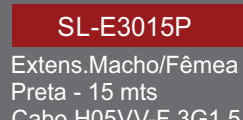

**SL-E3015P**

Extens.Macho/Fêmea Preta - 15 mts  
Cabo H05VV-F 3G1,5  
10/16A-250Vac-3680W  
Quant. Caixa: 4 pcs

**P.U. 34,00€**



**SL-E3020P**

Extens.Macho/Fêmea Preta - 20 mts  
Cabo H05VV-F 3G1,5  
10/16A-250Vac-3680W  
Quant. Caixa: 4 pcs

**P.U. 43,10€**

Quantidade Mínima 30 Unid.

Quantidade Mínima 30 Unid.

Quantidade Mínima 30 Unid.

Quantidade Mínima 30 Unid.

# Estações Carregamento de Parede ( Monofásicas 7,3KW )

Estações de Carregamento Tipo 2

Alimentação cabo 3G6 ( 3P+N+T) 32A ( Monofásica )

Caixa de Controle norma SEA J 1772 2010

Excelente desempenho de proteção, grau de proteção IP 55

Tensão corrente nominal: 400Vac - 10 a 32A

Carregamento 7,3KW (Máximo; 7,3Kw/h - 32A , Ajustável 6-10-16-20-25-32A )

Resistência de Isolamento: > 1000 Ohm ( 500V DC )

Caixa em Termoplástico, classe retardante de chama UI94 V-0

Ficha de Carregamento: Contactos Liga de cobre , Prata + Termo plástico na parte superior

Temperatura de Trabalho: -40° C ~ + 45° C

Proteção contra vazamento ( reiniciar carregamento )

Proteção de subtensão e sobretensão ( recuperação de autoverificação )

Proteção contra sobrecarga ( recuperação de autoverificação )

Tipo Instalação: Poste ( apropriado ) / Parede

Dimensões: 326mmx199mmx132mm

Peso: 5,6Kgs



## MBC-WB021F32A-10

- \* Wall Box Monofásica 32A / 7,3Kw (Máximo)
- \* Com Tomada Tipo 2 no painel
- \* Sem Interruptor Diferencial
- \* Ajustável 6 a 32A ( 2,1 a 7,3Kw )

P.U. 550,00€

## MBC-WB021F32A-10D

- \* Wall Box Monofásica 32A / 7,3Kw (Máximo)
- \* Com Tomada Tipo 2 no painel
- \* Com Interruptor Diferencial **TIPO A + DC**
- \* Ajustável 6 a 32A ( 2,1 a 7,3Kw )

P.U. 640,00€

## MBC-WB021F32A-15

- \* Wall Box Monofásica 32A / 7,3Kw (Máximo)
- \* Com Tomada Tipo 2 no painel
- \* Sem Interruptor Diferencial
- \* Ajustável 6 a 32A ( 2,1 a 7,3Kw )

\* Com RFID

P.U. 580,00€

## MBC-WB021F32A-15D

- \* Wall Box Monofásica 32A / 7,3Kw (Máximo)
- \* Com Tomada Tipo 2 no painel
- \* Com Interruptor Diferencial **TIPO A+DC**
- \* Ajustável 6 a 32A ( 2,1 a 7,3Kw )

\* Com RFID

P.U. 670,00€

## Com Controlo Dinâmico de Carregamento

## MBC-WB021F32A-50

- \* Wall Box Monofásica 32A / 7,3Kw (Máximo)
- \* Com 5 mts Cabo + Ficha Tipo 2
- \* Sem Interruptor Diferencial
- \* **Com Controlo Dinâmico de Carregamento**  
( Ajusta automaticamente o carregamento com a potencia disponível na Instalação )
- \* Display 4,3"
- \* RFID

P.U. 2300,00€



## MBC-WB021F32A-20

- \* Wall Box Monofásica 32A / 7,3Kw (Máximo)
- \* Com 5 mts Cabo + Ficha Tipo 2
- \* Sem Interruptor Diferencial
- \* Ajustável 6 a 32A ( 2,1 a 7,3Kw )

P.U. 660,00€

## MBC-WB021F32A-20D

- \* Wall Box Monofásica 32A / 7,3Kw (Máximo)
- \* Com 5 mts Cabo + Ficha Tipo 2
- \* Com Interruptor Diferencial **TIPO A+DC**
- \* Ajustável 6 a 32A ( 2,1 a 7,3Kw )

P.U. 760,00€

## MBC-WB021F32A-25

- \* Wall Box Monofásica 32A / 7,3Kw (Máximo)
- \* Com 5 mts Cabo + Ficha Tipo 2
- \* Sem Interruptor Diferencial
- \* Ajustável 6 a 32A ( 2,1 a 7,3Kw )

\* Com RFID

P.U. 690,00€

## MBC-WB021F32A-25D

- \* Wall Box Monofásica 32A / 7,3Kw (Máximo)
- \* Com 5 mts Cabo + Ficha Tipo 2
- \* Com Interruptor Diferencial **TIPO A+DC**
- \* Ajustável 6 a 32A ( 2,1 a 7,3Kw )

\* Com RFID

P.U. 790,00€



# Estações Carregamento de Parede ( Trifásicas 22KW )

Estações de Carregamento Tipo 2

Alimentação cabo 5G6 ( 3P+N+T) 32A ( Trifásica )

Caixa de Controle norma SEA J 1772 2010

Excelente desempenho de proteção, grau de proteção IP 55

Tensão corrente nominal: 400Vac - 10 a 32A

Carregamento 22KW (Máximo; 22Kw/h - 32A , Ajustável 6-10-16-20-25-32A )

Resistência de Isolamento: > 1000 Ohm ( 500V DC )

Caixa em Termoplástico, classe retardante de chama UI94 V-0

Ficha de Carregamento: Contactos Liga de cobre , Prata + Termo plástico na parte superior

Temperatura de Trabalho: -40° C ~ + 45° C

Proteção contra vazamento ( reiniciar carregamento )

Proteção de subtensão e sobretensão ( recuperação de autoverificação )

Proteção contra sobrecarga ( recuperação de autoverificação )

Tipo Instalação: Poste ( apropriado ) / Parede

Dimensões: 326mmx199mmx132mm

Peso: 5,6Kgs



## MBC-WB023F32A-08

- \* Wall Box Trifásica 16A / 11Kw
- \* Com Tomada Tipo 2 no painel
- \* Sem Interruptor Diferencial
- \* Ajustável 6 a 16A ( 2,1 a 11Kw )

P.U. 575,00€

## MBC-WB023F32A-10

- \* Wall Box Trifásica 32A / 22Kw
- \* Com Tomada Tipo 2 no painel
- \* Sem Interruptor Diferencial
- \* Ajustável 6 a 32A ( 2,1 a 22Kw )

P.U. 590,00€

## MBC-WB023F32A-08D

- \* Wall Box Trifásica 16A / 11Kw
- \* Com Tomada Tipo 2 no painel
- \* Com Int. Diferencial **TIPO A+DC**
- \* Ajustável 6 a 32A ( 2,1 a 11Kw )

P.U. 690,00€

## MBC-WB023F32A-10D

- \* Wall Box Trifásica 32A / 22Kw
- \* Com Tomada Tipo 2 no painel
- \* Com Int. Diferencial **TIPO A+DC**
- \* Ajustável 6 a 32A ( 2,1 a 22Kw )

P.U. 705,00€

## MBC-WB023F32A-15

- \* Wall Box Trifásica 32A / 22Kw
- \* Com Tomada Tipo 2 no painel
- \* Sem Interruptor Diferencial
- \* Ajustável 6 a 32A ( 2,1 a 22Kw )

\* Com RFID  
P.U. 620,00€

## MBC-WB023F32A-15D

- \* Wall Box Trifásica 32A / 22Kw
- \* Com Tomada Tipo 2 no painel
- \* Com Int. Diferencial **TIPO A+DC**
- \* Ajustável 6 a 32A ( 2,1 a 22Kw )

\* Com RFID  
P.U. 735,00€



## MBC-WB023F32A-18

- \* Wall Box Trifásica 32A / 11Kw
- \* Com 5 mts Cabo + Ficha Tipo 2
- \* Sem Interruptor Diferencial
- \* Ajustável 6 a 16A ( 2,1 a 11Kw )

P.U. 670,00€

## MBC-WB023F32A-20

- \* Wall Box Trifásica 32A / 22Kw
- \* Com 5 mts Cabo + Ficha Tipo 2
- \* Sem Interruptor Diferencial
- \* Ajustável 6 a 32A ( 2,1 a 22Kw )

P.U. 760,00€

## MBC-WB023F32A-18D

- \* Wall Box Trifásica 32A / 11Kw
- \* Com 5 mts Cabo + Ficha Tipo 2
- \* Com Int. Diferencial **TIPO A+DC**
- \* Ajustável 6 a 16A ( 2,1 a 11Kw )

P.U. 790,00€

## MBC-WB023F32A-20D

- \* Wall Box Trifásica 32A / 22Kw
- \* Com 5 mts Cabo + Ficha Tipo 2
- \* Com Int. Diferencial **TIPO A+DC**
- \* Ajustável 6 a 32A ( 2,1 a 22Kw )

P.U. 890,00€

## MBC-WB023F32A-25

- \* Wall Box Trifásica 32A / 22Kw
- \* Com 5 mts Cabo + Ficha Tipo 2
- \* Sem Interruptor Diferencial
- \* Ajustável 6 a 32A ( 2,1 a 22Kw )

\* Com RFID  
P.U. 790,00€

## MBC-WB023F32A-25D

- \* Wall Box Trifásica 32A / 22Kw
- \* Com 5 mts Cabo + Ficha Tipo 2
- \* Com Int. Diferencial **TIPO A+DC**
- \* Ajustável 6 a 32A ( 2,1 a 22Kw )

\* Com RFID  
P.U. 920,00€



### Com Controlo Dinâmico de Carregamento

#### MBC-WB023F32A-50

- \* Wall Box Trifásica 32A / 22Kw (Máximo)
- \* Com 5 mts Cabo + Ficha Tipo 2
- \* Sem Interruptor Diferencial
- \* Com Controlo Dinâmico de Carregamento  
( Ajusta automaticamente o carregamento com a potência disponível na Instalação)
- \* Display 4,3"
- \* RFID

P.U. 2400,00€

## Carregadores Corrente Contínua ( Carregadores Rápidos em DC )



#### MBC-WBDC-15KW

Carregador Corrente Continua Ficha CCS 2  
3 Fases + N + PE  
Input: 400V +- 10%  
Output: 15Kw  
Ficha de Carregamento SEA J 1172 2010 Standard ( CCS 2 )  
Excelente desempenho de proteção, grau de proteção IP 54  
Tipo Instalação Parede ou Poste apropriado  
Display TFT Touch Sreen  
RFID Mifare ( Classico, DesFire EV 1 )  
Carregador, Model 4  
Dimensões: 610x430x205mm  
P.U. s/consulta

#### MBC-WBDC-20KW

Carregador Corrente Continua Ficha CCS 2  
3 Fases + N + PE  
Input: 400V +- 10%  
Output: 20Kw  
Ficha de Carregamento SEA J 1172 2010 Standard ( CCS 2 )  
Excelente desempenho de proteção, grau de proteção IP 54  
Tipo Instalação Parede ou Poste apropriado  
Display TFT Touch Sreen  
RFID Mifare ( Classico, DesFire EV 1 )  
Carregador, Model 4  
Dimensões: 610x430x205mm  
P.U. 15900,00€

#### MBC-WBDC-30KW

Carregador Corrente Continua Ficha CCS 2  
3 Fases + N + PE  
Input: 400V +- 10%  
Output: 30Kw  
Ficha de Carregamento SEA J 1172 2010 Standard ( CCS 2 )  
Excelente desempenho de proteção, grau de proteção IP 54  
Tipo Instalação Parede ou Poste apropriado  
Display TFT Touch Sreen  
RFID Mifare ( Classico, DesFire EV 1 )  
Carregador, Model 4  
Dimensões: 610x430x205mm  
P.U. 20700,00€

#### MBC-WBDC-40KW

Carregador Corrente Continua Ficha CCS 2  
3 Fases + N + PE  
Input: 400V +- 10%  
Output: 40Kw  
Ficha de Carregamento SEA J 1172 2010 Standard ( CCS 2 )  
Excelente desempenho de proteção, grau de proteção IP 54  
Tipo Instalação Parede ou Poste apropriado  
Display TFT Touch Sreen  
RFID Mifare ( Classico, DesFire EV 1 )  
Carregador, Model 4  
Dimensões: 610x430x205mm  
P.U. 25500,00€

# Carregadores Portáteis

## MBC-POR021F32A

Carregador Portátil Tipo 2  
P.U. 825,00€

## MBC-POR011F32A

Carregador Portátil Tipo 1  
P.U. 825,00€

Ficha de Carregamento SEA J 1172 2010 Standard ( Tipo 2 )  
Ficha de Alimentação Tipo CEE 32A ( Monofásico )  
Caixa de Controle norma SEA J 1772 2010  
Excelente desempenho de proteção, grau de proteção IP 55  
Tensão corrente nominal: 230Vac - 32A  
Carregamento Máximo; 7,2 Kw/h ( Ajustável 2,2Kw/h / 3,5Kw/h / 7,2Kw/h )  
Resistência de Isolamento: > 1000Ohm ( 500V DC )  
Caixa em Termoplástico, classe retardante de chama UL 94 V-0  
Ficha de Carregamento: Contactos Liga de cobre , Prata + Termo plástico na parte superior  
Temperatura de Trabalho: -30° C ~ + 50° C  
Proteção contra vazamento ( reiniciar carregamento )  
Proteção de subtensão e de sobretensão ( recuperação de autoverificação )  
Proteção contra sobrecarga ( recuperação de autoverificação )  
Proteção de Iluminação ( indicação em Led )



## MBC-POR011F16A

### Ficha Tipo 1

Carregador Portátil Tipo 1  
P.U. 455,00€

## MBC-POR021F16A

### Ficha Tipo 2

Carregador Portátil Tipo 2  
P.U. 455,00€

Ficha de Carregamento SEA J 1172 2010 Standard ( Tipo 1 / Tipo 2 )  
Ficha de Alimentação Tipo Schuko 16A ( Monofásico )  
Caixa de Controle norma SEA J 1772 2010  
Excelente desempenho de proteção, grau de proteção IP 55  
Tensão corrente nominal: 230Vac - 16A  
Carregamento Máximo: 3,5 Kw/h  
Resistência de Isolamento: > 1000Ohm ( 500V DC )  
Caixa em Termoplástico, classe retardante de chama UI94 V-0  
Ficha de Carregamento: Contactos Liga de cobre , Prata + Termo plástico na parte superior  
Temperatura de Trabalho: -30° C ~ + 50° C  
Proteção contra vazamento ( reiniciar carregamento )  
Proteção de subtensão e de sobretensão ( recuperação de autoverificação )  
Proteção contra sobrecarga ( recuperação de autoverificação )  
Proteção de Iluminação ( indicação em Led )



## MBC-POR02332A

Carregador Portatil Trifásico  
Tomada Tipo 2 SEA J 1172 2010 Standard ( Tipo 2 )  
Alimentação cabo 5G6 ( 3P+N+T ) 32A ( Trifásico )  
Caixa de Controle norma SEA J 1772 2010  
Excelente desempenho de proteção, grau de proteção IP 55  
Tensão corrente nominal: 400Vac - 10 a 32A  
Carregamento Máximo; 22Kw/h - 32A ( Ajustável 10-16-20-25-32A )  
Resistência de Isolamento: > 1000 Ohm ( 500V DC )  
Caixa em Termoplástico, classe retardante de chama UI94 V-0  
Ficha de Carregamento: Contactos Liga de cobre , Prata + Termo plástico na parte superior  
Temperatura de Trabalho: -40° C ~ + 45° C  
Proteção contra vazamento ( reiniciar carregamento )  
Proteção de subtensão e de sobretensão ( recuperação de autoverificação )  
Proteção contra sobrecarga ( recuperação de autoverificação )  
Tipo Instalação: Poste ( apropriado ) / Parede  
Dimensões: 326mmx199mmx132mm  
Peso: 2,8Kgs

P.U. 1690,00€



## Cabos e Acessórios

Novos  
Produtos**MBC-PEDESTAL-10**

Pedestal para uma Wall Box  
 Altura: 1200mm  
 Base: 300mm  
 P.U. 670,00€

**MBC-PEDESTAL-20**

Pedestal para uma Wall Box  
 Altura: 1200mm  
 Base: 300mm  
 P.U. 810,00€

**MBC-CAB01021F16A**

Cabo 3G2,5 com 5 mts Fichas Tipo 1 / Tipo 2  
 Fichas de Carregamento conforme norma 62196-2 IEC 2010  
 Design ergonómicos, portátil, fácil utilização  
 Fiabilidade dos materiais:  
 - Antiespuma, Resistência à Pressão; Resistência à Abrasão  
 - Resistência ao Impacto, Resistência aos óleos  
 Excelente desempenho de proteção, grau de proteção IP 55  
 Tensão corrente nominal: 230Vac - 16A  
 Corrente nominal: Máximo 16A ( Monofásico )  
 Carregamento Máximo; 3,5 Kw/h  
 Resistência de Isolamento: > 500Ohm ( 500V DC )  
 Caixa em Termoplástico, classe retardante de chama UI94 V-0  
 plástico, classe retardante de chama UL 94 V-0  
 Temperatura de Trabalho: -30° C ~ + 50° C

P.U. 285,00€

**MBC-CAB01021F32A**

Cabo 3G6 com 5 mts Fichas Tipo 1 / Tipo 2  
 Fichas de Carregamento conforme norma 62196-2 IEC 2010  
 Montagem conforme norma IEC 61851-1 2010 modo de Carregamento 3 método conexão B2  
 Design ergonómicos, portátil, fácil utilização  
 Fiabilidade dos materiais:  
 - Antiespuma, Resistência à Pressão; Resistência à Abrasão  
 - Resistência ao Impacto, Resistência aos óleos  
 Excelente desempenho de proteção, grau de proteção IP 55  
 Tensão corrente nominal: 250Vac / 415Vac - 32A  
 Corrente nominal: Máximo 32A ( Monofásico )  
 Carregamento Máximo; 7,2 Kw/h  
 Resistência de Isolamento: > 500Ohm ( 500V DC )  
 Caixa em Termoplástico, classe retardante de chama UL 94 V-0  
 Ficha de Carregamento: Contactos Liga de cobre, Prata + Termo plástico na parte superior  
 Temperatura de Trabalho: -30° C ~ + 50° C

P.U. 330,00€

**MBC-CAB02021F16A**

Cabo 3G2,5 com 5 mts Fichas Tipo 2 / Tipo 2  
 Fichas de Carregamento conforme norma 62196-2 IEC 2010  
 Montagem conforme norma IEC 61851-1 2010 modo de Carregamento 3 método conexão B2  
 Design ergonómicos, portátil, fácil utilização  
 Fiabilidade dos materiais:  
 - Antiespuma, Resistência à Pressão; Resistência à Abrasão  
 - Resistência ao Impacto, Resistência aos óleos  
 Excelente desempenho de proteção, grau de proteção IP 55  
 Tensão corrente nominal: 250Vac / 415Vac - 16A  
 Corrente nominal: Máximo 16A ( Monofásico )  
 Carregamento Máximo; 3,5 Kw/h  
 Resistência de Isolamento: > 500Ohm ( 500V DC )  
 Caixa em Termoplástico, classe retardante de chama UI94 V-0  
 Ficha de Carregamento: Contactos Liga de cobre, Prata + Termo plástico na parte superior  
 Temperatura de Trabalho: -30° C ~ + 50° C

P.U. 285,00€



## MBC-CAB02023F16A

Cabo 5G2,5 com 5 mts Fichas Tipo 2 / Tipo 2  
Fichas de Carregamento conforme norma 62196-2 IEC 2010  
Montagem conforme norma IEC 61851-1 2010 modo de Carregamento 3 método conexão B2  
Design ergonómicos, portátil , fácil utilização  
Fiabilidade dos materiais:  
- Antiespuma, Resistência à Pressão; Resistência à Abrasão  
- Resistência ao Impacto, Resistência aos óleos  
Excelente desempenho de proteção, grau de proteção IP 55  
Tensão corrente nominal: 250Vac / 415Vac - 16A  
Corrente nominal: Máximo 16A ( Trifásico )  
Carregamento Máximo: 3,5 Kw/h  
Resistência de Isolamento: > 500Ohm ( 500V DC )  
Caixa em Termoplástico, classe retardante de chama UI94 V-0  
Plástico, classe retardante de chama UL 94 V-0  
Ficha de Carregamento: Contactos Liga de cobre , Prata + Termo plástico na parte superior  
Temperatura de Trabalho: -30° C ~ + 50° C  
**P.U. 340,00€**



Novos  
Podutos

Novos  
Podutos

## MBC-CAB02023F32A

Com 5mts Cabo 5G6 Fichas Tipo 2 / Tipo 2  
**P.U. 390,00**

## MBC-CAB02023F32A-7

Com 7mts Cabo 5G6 Fichas Tipo 2 / Tipo 2  
**P.U. 505,00**

## MBC-CAB02023F32A-10

Com 10mts Cabo 5G6 Fichas Tipo 2 / Tipo 2  
**P.U. 630,00**



Cabo 5G6 Fichas Tipo 2 / Tipo 2  
Fichas de Carregamento conforme norma 62196-2 IEC 2010  
Montagem conforme norma IEC 61851-1 2010 modo de Carregamento 3 método conexão B2  
Design ergonómicos, portátil , fácil utilização  
Fiabilidade dos materiais:  
- Antiespuma, Resistência à Pressão; Resistência à Abrasão  
- Resistência ao Impacto, Resistência aos óleos  
Excelente desempenho de proteção, grau de proteção IP 55  
Tensão corrente nominal: 250Vac / 415Vac - 32A  
Corrente nominal: Máximo 32A ( Trifásico )  
Carregamento Máximo; 22 Kw/h  
Resistência de Isolamento: > 500Ohm ( 500V DC )  
Caixa em Termoplástico, classe retardante de chama UI94 V-0  
Plástico, classe retardante de chama UL 94 V-0  
Ficha de Carregamento: Contactos Liga de cobre , Prata + Termo plástico na parte superior  
Temperatura de Trabalho: -30° C ~ + 50° C



## MBC-FF023F32A

Ficha fêmea Tipo 2  
32A  
Trifásica  
**P.U. 140,00€**



## MBC-FF013F32A

Ficha Fêmea Tipo 1  
32A  
**P.U. 135,00€**



## MBC-SUP-T2

Suporte para Ficha T2  
**P.U. 15,00€**



## MBC-FM023F32A

Ficha Macho Tipo 2  
32A  
Trifásica  
**P.U. 115,00€**



## MBC-TE013F32A

Tomada Encastrar Tipo 1  
32A  
**P.U. 90,00€**



## MBC-TE023F32A

32A Trifásica  
Tomada Encastrar Tipo 2  
**P.U. 140,00€**

# Projetores em Gesso





Projetores Fabricados em Gesso e Metal na Cor Branca. Podem ser Pintados à cor da Parede / Teto



SL-G1010

Proj. Redondo em Gesso  
GU 10 - IP 20  
Aro: 100mm  
Furo: 100mm  
Altura: 30mm  
Quant. Emb.30 pcs  
**P.U. 10,30€**



SL-G1015

Proj. Redondo em Gesso  
GU 10 - IP 20  
Aro: 100mm  
Furo: 100mm  
Altura: 40mm  
Quant. Emb.24 pcs  
**P.U. 12,20€**



SL-G1016

Proj. Redondo em Gesso  
GU 10 - IP 20  
Aro: 130mm  
Furo: 130mm  
Altura: 55mm  
Quant. Emb.24 pcs  
**P.U. 16,75€**



SL-G1020

Proj. Quadrado em Gesso  
GU 10 - IP 20  
Aro: 100x100mm  
Furo: 100x100mm  
Altura: 30mm  
Quant. Emb.30 pcs  
**P.U. 10,30€**



SL-G1022

Proj. Duplo em Gesso  
Fixação no Teto  
GU 10 - IP 20  
Aro: 215x117mm  
Altura: 57mm  
Quant. Emb.12 pcs  
**P.U. 25,00€**



SL-G1025

Proj. Quadrado em Gesso  
GU 10 - IP 20  
Aro: 100x120mm  
Furo: 100x120mm  
Altura: 40mm  
Quant. Emb.24 pcs  
**P.U. 12,20€**



SL-G1026

Proj. Redondo em Gesso  
GU 10 - IP 20  
Aro: 120x120mm  
Furo: 120x120mm  
Altura: 60mm  
Quant. Emb.24 pcs  
**P.U. 16,80€**



SL-G1030

Proj. Redondo em Gesso  
GU 10 - IP 20  
Aro: 120x120mm  
Furo: 120x120mm  
Altura: 60mm  
Quant. Emb.24 pcs  
**P.U. 16,80€**



SL-G1050

Proj. Redondo em Gesso  
AR 111 - IP 20  
Aro: 253mm  
Furo: 253mm  
Altura: 60mm  
Quant. Emb.24 pcs  
**P.U. 59,40€**



SL-G1060

Proj. Redondo em Gesso  
AR 111 - IP 20  
Aro: 202X202mm  
Furo: 202X202mm  
Altura: 90mm  
Quant. Emb.24 pcs  
**P.U. 61,60€**



SL-G1062

Proj. Redondo em Gesso  
2x AR 111 - IP 20  
Aro: 362X202mm  
Furo: 362X202mm  
Altura: 90mm  
Quant. Emb.24 pcs  
**P.U. 88,30€**



SL-G5050-B

Proj. Quadrado em Gesso  
Fixação no Teto ( Branco/Preto )  
GU 10 - IP 20  
Dimensão: 100x100mm  
Comprimento: 170mm  
Quant. Emb. 9 pcs  
**P.U. 48,00€**



SL-G5050-C

Proj. Quadrado em Gesso  
Fixa. no Teto ( Branco/Cromado )  
GU 10 - IP 20  
Dimensão: 100x100mm  
Comprimento: 170mm  
Quant. Emb. 9 pcs  
**P.U. 48,00€**



SL-G5050-G

Proj. Quadrado em Gesso  
Fixa. no Teto ( Branco/dourado )  
GU 10 - IP 20  
Dimensão: 100x100mm  
Comprimento: 170mm  
Quant. Emb. 9 pcs  
**P.U. 48,00€**



SL-G2010

Proj. Redondo em Gesso  
Fixação no Teto  
GU 10 - IP 20  
Diâmetro: 70mm  
Comprimento: 220mm  
Quant. Emb.18 pcs  
**P.U. 30,40€**



SL-G2015

Proj. Redondo em Gesso  
Fixação na Parede Down  
GU 10 - IP 20  
Diâmetro: 70mm  
Comprimento: 220mm  
Quant. Emb.18 pcs  
**P.U. 36,80€**



SL-G2020

Proj. Redondo em Gesso  
Fixação na Parede Up/down  
2xGU 10 - IP 20  
Diâmetro: 70mm  
Comprimento: 220mm  
Quant. Emb.18 pcs  
**P.U. 36,80€**



SL-G2025

Proj. Redondo em Gesso  
Suspensão  
GU 10 - IP 20  
Diâmetro: 70mm  
Comprimento: 220mm  
Quant. Emb.9 pcs  
**P.U. 46,30€**

# Projetores em Gesso

Projetores Fabricados em Gesso e Metal na Cor Branca. Podem ser Pintados à cor da Parede / Teto



**SL-G3010**

Projeto Quadrado em Gesso  
Fixação no Teto  
GU 10 - IP 20  
Dimensões: 70x70mm  
Comprimento: 220mm  
Quant. Emb. 18 pcs  
**P.U. 30,40€**



**SL-G3015**

Proj. Quadrado em Gesso  
Fixação na Parede Down  
GU 10 - IP 20  
Dimensões: 70x70mm  
Comprimento: 220mm  
Quant. Emb. 18 pcs  
**P.U. 34,00€**



**SL-G3020**

Proj. Quadrado em Gesso  
Fixação na Parede Up/down  
2xGU 10 - IP 20  
Dimensões: 70x70mm  
Comprimento: 220mm  
Quant. Emb. 18 pcs  
**P.U. 37,00€**



**SL-G3025**

Proj. Quadrado em Gesso  
Suspensão  
GU 10 - IP 20  
Dimensões: 70x70mm  
Comprimento: 220mm  
Quant. Emb. 9 pcs  
**P.U. 46,50€**



**SL-G5015**

Projeto Quadrado em Gesso  
Fixação Parede Up/Down  
G 9 - IP 20  
Dimensões: 115x115mm  
Comprimento: 115mm  
Quant. Emb. 12 pcs  
**P.U. 30,40€**



**SL-G5020**

Proj. Oval em Gesso  
Fixação na Parede Up/Down  
G 9 - IP 20  
Dimensões: 200x120mm  
Profundidade: 80mm  
Quant. Emb. 12 pcs  
**P.U. 37,00€**



**SL-G5025**

Proj. Rectangular em Gesso  
Fixação na Parede Up/down  
E14 - IP 20  
Dimensões: 90x90mm  
Comprimento: 245mm  
Quant. Emb. 9 pcs  
**P.U. 40,00€**



**SL-G9010**

Proj. Parede em Gesso  
Embutir na Parede (Down)  
GU 10(35mm) - IP 20  
Dimensões: 100x100mm  
Profundidade: 40mm  
Quant. Emb. 50 pcs  
**P.U. 12,50€**



**SL-G9020**

Projeto Quadrado em Gesso  
Embutir na Parede (Down)  
GU 10(35mm) - IP 20  
Dimensões: 245x110mm  
Profundidade: 50mm  
Quant. Emb. 12 pcs  
**P.U. 30,50€**



**SL-G6010**

Suspensão em Gesso  
Suspensão  
G 9 - IP 20  
Diâmetro: 230mm  
Comprimento: 120mm  
Quant. Emb. 8 pcs  
**P.U. 75,00€**



**SL-G6020**

Suspensão em Gesso  
Suspensão  
E14 - IP 20  
Diâmetro: 150mm  
Comprimento: 250mm  
Quant. Emb. 4 pcs  
**P.U. 79,00€**



## Downlight Baixo Perfil Saliente IP 44



**SL60011BR-S-9W-84**

4200K, 900lm, 9W  
Branco  
Diâmetro: 120mm  
Altura 35mm  
Quant. Emb.50 pcs  
**P.U. 11,90€**

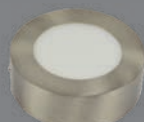

**SL60011AE-S-9W-84**

4200K, 900lm, 9W  
Aço Escovado  
Diâmetro: 120mm  
Altura 35mm  
Quant. Emb.50 pcs  
**P.U. 15,00€**



**SL70011BR-S-9W-84**

4200K, 900lm, 9W  
Branco  
Dimensões: 125x125mm  
Altura 36mm  
Quant. Emb.50 pcs  
**P.U. 15,50€**



**SL70011AE-S-9W-84**

4200K, 900lm, 9W  
Aço Escovado  
Dimensões: 125x125mm  
Altura 36mm  
Quant. Emb.50 pcs  
**P.U. 18,80€**



**SL60011BR-S-20W-84**

4200K, 1500lm, 20W  
Branco  
Diâmetro: 225mm  
Altura 35mm  
Quant. Emb.20 pcs  
**P.U. 21,90€**

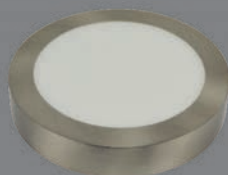

**P.U. SL60011AE-S-20W-84**

4200K, 1500lm, 20W  
Aço Escovado  
Diâmetro: 225mm  
Altura 35mm  
Quant. Emb.20 pcs  
**P.U. 27,10€**



**SL70011BR-S-20W-84**

4200K, 1500lm, 20W  
Branco  
Dimensões: 225x225mm  
Altura 36mm  
Quant. Emb.20 pcs  
**P.U. 24,50€**



**SL70011AE-S-20W-84**

4200K, 1500lm, 20W  
Aço Escovado  
Dimensões: 225x225mm  
Altura 36mm  
Quant. Emb.20 pcs  
**P.U. 30,90€**



**SL60011BR-3W-82**

2700K, 345lm, 3W  
Branco / IP 44  
Aro: 85mm  
Furo: 75mm  
Altura: 13mm  
Quant. Emb.50 pcs  
**P.U. 9,50€**



**SL60011BR-5W-82**

2700K, 400lm, 5W  
Branco / IP 44  
Aro: 85mm  
Furo: 75mm  
Altura: 13mm  
Quant. Emb.50 pcs  
**P.U. 12,00€**



**SL60011BR-9W-82**

2700K, 690lm, 9W  
Branco / IP 44  
Aro.: 120mm  
Furo: 105mm  
Altura: 13mm  
Quant. Emb.50 pcs  
**P.U. 8,95€**



**SL60011BR-12W-82**

2700K, 1380lm, 12W  
Branco / IP 44  
Aro: 170mm  
Furo: 160mm  
Altura: 13mm  
Quant. Emb.20 pcs  
**P.U. 11,75€**



**SL60011BR-20W-82**

2700K, 2070lm, 20W  
Branco / IP 44  
Aro: 225mm  
Furo: 205mm  
Altura: 13mm  
Quant. Emb.20 pcs  
**P.U. 15,30€**

**SL60011BR-3W-84**

4200K, 345lm, 3W  
Branco / IP 44  
Aro: 85mm  
Furo: 75mm  
Altura: 13mm  
Quant. Emb.50 pcs  
**P.U. 9,50€**

**SL60011BR-5W-84**

4200K, 400lm, 5W  
Branco / IP 44  
Aro: 85mm  
Furo: 75mm  
Altura: 13mm  
Quant. Emb.50 pcs  
**P.U. 12,00€**

**SL60011BR-9W-84**

4200K, 690lm, 9W  
Branco / IP 44  
Aro.: 120mm  
Furo: 105mm  
Altura: 13mm  
Quant. Emb.50 pcs  
**P.U. 8,95€**

**SL60011BR-12W-84**

4200K, 1380lm, 12W  
Branco / IP 44  
Aro: 170mm  
Furo: 160mm  
Altura: 13mm  
Quant. Emb.20 pcs  
**P.U. 11,75€**

**SL60011BR-20W-84**

4200K, 2070lm, 20W  
Branco / IP 44  
Aro: 225mm  
Furo: 205mm  
Altura: 13mm  
Quant. Emb.20 pcs  
**P.U. 15,30€**

### Downlight Baixo Perfil Dimável

**SL60011BR-5W-82-D**

2700K- 400lm 5W  
Branco / IP 44  
**P.U. 26,75€**

**SL60011BR-12W-82-D**

2700K, 920lm, 12W  
Branco / IP 44  
**P.U. 27,30€**

**SL60011BR-5W-84-D**

4200K,400lm, 5W  
Branco / IP 44  
**P.U. 26,75€**

**SL60011BR-12W-84-D**

4200K, 1380lm, 12W  
Branco / IP 44  
**P.U. 27,30€**

**SL60011BR-9W-82-D**

2700K, 690lm, 9W  
Branco / IP 44  
**P.U. 24,65€**

**SL60011BR-20W-82-D**

2700K, 1500lm, 20W  
Branco / IP 44  
**P.U. 36,20€**

**SL60011BR-9W-84-D**

4200K- 690lm 9W  
Branco / IP 44  
**P.U. 24,65€**

**SL60011BR-20W-84-D**

4200K, 2070lm, 20W  
Branco / IP 44  
**P.U. 36,20€**



**SL60011AE-3W-82**

2700K, 345lm, 3W  
Aço Escovado / IP 44  
Aro: 85mm  
Furo: 75mm  
Altura: 13mm  
Quant. Emb.50 pcs  
**P.U. 10,30€**



**SL60011AE-5W-82**

2700K, 400lm, 5W  
Aço Escovado / IP 44  
Aro: 85mm  
Furo: 75mm  
Altura: 13mm  
Quant. Emb.50 pcs  
**P.U. 13,20€**

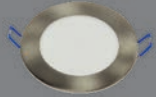

**SL60011AE-9W-82**

2700K, 690lm, 9W  
Aço Escovado / IP 44  
Aro.: 120mm  
Furo: 105mm  
Altura: 13mm  
Quant. Emb.50 pcs  
**P.U. 11,40€**



**SL60011AE-12W-82**

2700K, 1380lm, 12W  
Aço Escovado / IP 44  
Aro: 170mm  
Furo: 160mm  
Altura: 13mm  
Quant. Emb.20 pcs  
**P.U. 17,90€**



**SL60011AE-20W-82**

2700K, 2070lm, 20W  
Aço Escovado / IP 44  
Aro: 225mm  
Furo: 205mm  
Altura: 13mm  
Quant. Emb.20 pcs  
**P.U. 21,70€**

**SL60011AE-3W-84**

4200K, 345lm, 3W  
Aço Escovado / IP 44  
Aro: 85mm  
Furo: 75mm  
Altura: 13mm  
Quant. Emb.50 pcs  
**P.U. 10,30€**

**SL60011AE-5W-84**

4200K, 400lm, 5W  
Aço Escovado / IP 44  
Aro: 85mm  
Furo: 75mm  
Altura: 13mm  
Quant. Emb.50 pcs  
**P.U. 13,20€**

**SL60011AE-9W-84**

4200K, 690lm, 9W  
Aço Escovado / IP 44  
Aro.: 120mm  
Furo: 105mm  
Altura: 13mm  
Quant. Emb.50 pcs  
**P.U. 11,40€**

**SL60011AE-12W-84**

4200K, 1380lm, 12W  
Aço Escovado / IP 44  
Aro: 170mm  
Furo: 160mm  
Altura: 13mm  
Quant. Emb.20 pcs  
**P.U. 17,90€**

**SL60011AE-20W-84**

4200K, 2070lm, 20W  
Aço Escovado / IP 44  
Aro: 225mm  
Furo: 205mm  
Altura: 13mm  
Quant. Emb.20 pcs  
**P.U. 21,70€**

### Downlight Baixo Perfil Dimável

**SL60011AE-5W-82-D**

2700K- 400lm 5W  
Aço Escovado / IP 44  
**P.U. 27,70€**

**SL60011AE-12W-82-D**

2700K, 920lm, 12W  
Aço Escovado / IP 44  
**P.U. 33,50€**

**SL60011AE-5W-84-D**

4200K- 400lm 5W  
Aço Escovado / IP 44  
**P.U. 27,70€**

**SL60011AE-12W-84-D**

4200K, 1380lm, 12W  
Aço Escovado / IP 44  
**P.U. 33,50€**

**SL60011AE-9W-82-D**

2700K, 690lm, 9W  
Aço Escovado / IP 44  
**P.U. 25,85€**

**SL60011AE-20W-82-D**

2700K, 1500lm, 20W  
Aço Escovado / IP 44  
**P.U. 42,00€**

**SL60011AE-9W-84-D**

4200K- 690lm 9W  
Aço Escovado / IP 44  
**P.U. 25,85€**

**SL60011AE-20W-84-D**

4200K, 2070lm, 20W  
Aço Escovado / IP 44  
**P.U. 42,00€**

# Downlight Baixo Perfil Led

CASAMBI Opção Casambi e Dalli por Encomenda



**SL70011BR-3W-82**

2700K, 345lm, 3W  
Branco / IP 44  
Aro: 85x85mm  
Furo 75x75mm  
Altura: 13mm  
Quant. Emb.50 pcs  
**P.U. 11,30€**



**SL70011BR-5W-82**

2700K, 400lm, 5W  
Branco / IP 44  
Aro: 85x85mm  
Furo 75x75mm  
Altura: 13mm  
Quant. Emb.50 pcs  
**P.U. 12,30€**



**SL70011BR-9W-82**

2700K, 690lm, 9W  
Branco / IP 44  
Aro.: 120x120mm  
Furo: 105x105mm  
Altura: 13mm  
Quant. Emb.50 pcs  
**P.U. 9,15€**



**SL70011BR-12W-82**

2700K, 1380lm, 12W  
Branco / IP 44  
Aro: 170x170mm  
Furo: 160x160mm  
Altura: 13mm  
Quant. Emb.20 pcs  
**P.U. 12,95€**



**SL70011BR-20W-82**

2700K, 2070lm, 20W  
Branco / IP 44  
Aro: 225x225mm  
Furo: 205x205mm  
Altura: 13mm  
Quant. Emb.20 pcs  
**P.U. 16,75€**

**SL70011BR-3W-84**

4200K, 345lm, 3W  
Branco / IP 44  
Aro: 85x85mm  
Furo: 75x75mm  
Altura: 13mm  
Quant. Emb.50 pcs  
**P.U. 11,30€**

**SL70011BR-5W-84**

4200K, 400lm, 5W  
Branco / IP 44  
Aro: 85x85mm  
Furo: 75x75mm  
Altura: 13mm  
Quant. Emb.50 pcs  
**P.U. 12,30€**

**SL70011BR-9W-84**

4200K, 690lm, 9W  
Branco / IP 44  
Aro.: 120x120mm  
Furo: 105x105mm  
Altura: 13mm  
Quant. Emb.50 pcs  
**P.U. 9,15€**

**SL70011BR-12W-84**

4200K, 1380lm, 12W  
Branco / IP 44  
Aro: 170x170mm  
Furo: 160x160mm  
Altura: 13mm  
Quant. Emb.20 pcs  
**P.U. 12,95€**

**SL70011BR-20W-84**

4200K, 2070lm, 20W  
Branco / IP 44  
Aro: 225x225mm  
Furo: 205x205mm  
Altura: 13mm  
Quant. Emb.20 pcs  
**P.U. 16,75€**

## Downlight Baixo Perfil Dimável

**SL70011BR-5W-82-D**

2700K, 400lm, 5W  
Branco / IP 44  
**P.U. 26,75€**

**SL70011BR-12W-82-D**

2700K, 920lm, 12W  
Branco / IP 44  
**P.U. 28,65€**

**SL70011BR-5W-84-D**

4200K, 400lm, 5W  
Branco / IP 44  
**P.U. 26,75€**

**SL70011BR-12W-84-D**

4200K, 1380lm, 12W  
Branco / IP 44  
**P.U. 28,65€**

**SL70011BR-9W-82-D**

2700K, 690lm, 9W  
Branco / IP 44  
**P.U. 23,60€**

**SL70011BR-20W-82-D**

2700K, 1500lm, 20W  
Branco / IP 44  
**P.U. 37,00€**

**SL70011BR-9W-84-D**

4200K- 690lm 9W  
Branco / IP 44  
**P.U. 23,60€**

**SL70011BR-20W-84-D**

4200K, 2070lm, 20W  
Branco / IP 44  
**P.U. 37,00€**



**SL70011AE-3W-82**

2700K, 345lm, 3W  
Aço Escovado / IP 44  
Aro: 85x85mm  
Furo: 75x75mm  
Altura: 13mm  
Quant. Emb.50 pcs  
**P.U. 11,70€**



**SL70011AE-5W-82**

2700K, 400lm, 5W  
Aço Escovado / IP 44  
Aro: 85x85mm  
Furo: 75x75mm  
Altura: 13mm  
Quant. Emb.50 pcs  
**P.U. 13,50€**



**SL70011AE-9W-82**

2700K, 690lm, 9W  
Aço Escovado / IP 44  
Aro.: 120x120mm  
Furo: 105x105mm  
Altura: 13mm  
Quant. Emb.50 pcs  
**P.U. 12,15€**



**SL70011AE-12W-82**

2700K, 1380lm, 12W  
Aço Escovado / IP 44  
Aro: 170x170mm  
Furo: 160x160mm  
Altura: 13mm  
Quant. Emb.20 pcs  
**P.U. 19,50€**



**SL70011AE-20W-82**

2700K, 2070lm, 20W  
Aço Escovado / IP 44  
Aro: 225x225mm  
Furo: 205x205mm  
Altura: 13mm  
Quant. Emb.20 pcs  
**P.U. 23,15€**

**SL70011AE-3W-84**

4200K, 345lm, 3W  
Aço Escovado / IP 44  
Aro: 85x85mm  
Furo: 75x75mm  
Altura: 13mm  
Quant. Emb.50 pcs  
**P.U. 11,70€**

**SL70011AE-5W-84**

4200K, 400lm, 5W  
Aço Escovado / IP 44  
Aro: 85x85mm  
Furo: 75x75mm  
Altura: 13mm  
Quant. Emb.50 pcs  
**P.U. 13,50€**

**SL70011AE-9W-84**

4200K, 690lm, 9W  
Aço Escovado / IP 44  
Aro.: 120x120mm  
Furo: 105x105mm  
Altura: 13mm  
Quant. Emb.50 pcs  
**P.U. 12,15€**

**SL70011AE-12W-84**

4200K, 1380lm, 12W  
Aço Escovado / IP 44  
Aro: 170x170mm  
Furo: 160x160mm  
Altura: 13mm  
Quant. Emb.20 pcs  
**P.U. 19,50€**

**SL70011AE-20W-84**

4200K, 2070lm, 20W  
Aço Escovado / IP 44  
Aro: 225x225mm  
Furo: 205x205mm  
Altura: 13mm  
Quant. Emb.20 pcs  
**P.U. 23,15€**

## Downlight Baixo Perfil Dimável

**SL70011AE-5W-82-D**

2700K, 400lm, 5W  
Aço Escovado / IP 44  
**P.U. 30,85€**

**SL70011AE-12W-82-D**

2700K, 920lm, 12W  
Aço Escovado / IP 44  
**P.U. 35,00€**

**SL70011AE-5W-84-D**

4200K, 400lm, 5W  
Aço Escovado / IP 44  
**P.U. 30,85€**

**SL70011AE-12W-84-D**

4200K, 1380lm, 12W  
Aço Escovado / IP 44  
**P.U. 35,00€**

**SL70011AE-9W-82-D**

2700K, 690lm, 9W  
Aço Escovado / IP 44  
**P.U. 26,65€**

**SL70011AE-20W-82-D**

2700K, 1500lm, 20W  
Aço Escovado / IP 44  
**P.U. 43,50€**

**SL70011AE-9W-84-D**

4200K- 690lm 9W  
Aço Escovado / IP 44  
**P.U. 26,65€**

**SL70011AE-20W-84-D**

4200K, 2070lm, 20W  
Aço Escovado / IP 44  
**P.U. 43,50€**



SL 50010BR

Aro Fixo Red. Zamak Branco / IP 20  
Aro: 78mm  
Furo: 65mm  
Altura: 24mm  
Quant. Emb.100 pcs  
P.U. 2,70€



SL 50010CR

Aro Fixo Red. Zamak Aço Escovado / IP 20  
Aro: 78mm  
Furo: 65mm  
Altura: 24mm  
Quant. Emb.100 pcs  
P.U. 3,38€



SL 50010DR

Aro Fixo Red. Zamak Ouro Velho / IP 20  
Aro: 78mm  
Furo: 65mm  
Altura: 24mm  
Quant. Emb.100 pcs  
P.U. 3,40€



SL 50020BR

Aro Orient. Red.Zamak Branco / IP 20  
Aro: 83mm  
Furo: 72mm  
Altura: 22mm  
Quant. Emb.100 pcs  
P.U. 4,30€



SL 50020CR

Aro Orient.Red.Zamak Aço Escovado / IP 20  
Aro: 83mm  
Furo: 72mm  
Altura: 22mm  
Quant. Emb.100 pcs  
P.U. 5,20€



SL 50020DR

Aro Orient. Red.Zamak Ouro Velho / IP 20  
Aro: 83mm  
Furo: 72mm  
Altura: 22mm  
Quant. Emb.100 pcs  
P.U. 5,25€

SL50010PT

Novos Podutos

Aro Fixo Red. Zamak Preto / IP 20  
Aro: 78mm  
Furo: 65mm  
Altura: 24mm  
Quant. Emb.100 pcs  
P.U. 3,40€

SL50020PT

Novos Podutos

Aro Orient. Red.Zamak Preto / IP 20  
Aro: 83mm  
Furo: 72mm  
Altura: 22mm  
Quant. Emb.100 pcs  
P.U. 5,25€



SL 50021BR

Aro Orient.Red.Zamak Branco / IP 20  
Aro: 92mm  
Furo: 72mm  
Altura: 22mm  
Quant. Emb.100 pcs  
P.U. 4,65€



SL 50021AE

Aro Orient.Red.Zamak Aço Escovado / IP 20  
Aro: 92mm  
Furo: 72mm  
Altura: 22mm  
Quant. Emb.100 pcs  
P.U. 5,57€



SL 50030BR

Aro Fixo Quad. Zamak Branco / IP 20  
Aro: 77x77mm  
Furo: 65mm  
Altura: 22mm  
Quant. Emb.100 pcs  
P.U. 2,86€



SL 50030CR

Aro Fixo Quad.Zamak Aço Escovado / IP 20  
Aro: 77x77mm  
Furo: 65mm  
Altura: 22mm  
Quant. Emb.100 pcs  
P.U. 3,56€



SL 50040BR

Aro Orient.Quad.Zamak Branco / IP 20  
Aro: 83x83mm  
Furo: 72mm  
Altura: 23mm  
Quant. Emb.100 pcs  
P.U. 4,58€



SL 50040CR

Aro Orient.Quad.Zamak Aço Escovado / IP 20  
Aro: 83x83mm  
Furo: 72mm  
Altura: 22mm  
Quant. Emb.100 pcs  
P.U. 5,56€



SL 50081-1

Aro Orient.Red.Zamak Alumínio / IP 20  
Aro: 92mm  
Furo: 80mm  
Altura: 26mm  
Quant. Emb.50 pcs  
P.U. 14,10€



SL 50081-1WH

Aro Orient.Red.Zamak Branco / IP 20  
Aro: 92mm  
Furo: 80mm  
Altura: 26mm  
Quant. Emb.50 pcs  
P.U. 13,80€

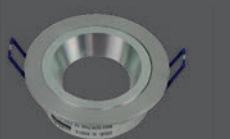

SL 50081-A-AL

Aro Fixo Red. Zamak Alumínio / IP 20  
Aro: 92mm  
Furo: 80mm  
Altura: 26mm  
Quant. Emb.50 pcs  
P.U. 15,26€

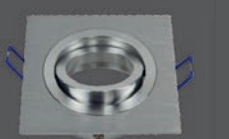

SL 50080-1

Aro Orient.Quad.Zamak Alumínio / IP 20  
Aro: 92mm  
Furo: 80mm  
Altura: 26mm  
Quant. Emb.50 pcs  
P.U. 14,21€



SL 50080-1WH

Aro Orient.Quad.Zamak Branco / IP 20  
Aro: 92mm  
Furo: 80mm  
Altura: 26mm  
Quant. Emb.50 pcs  
P.U. 13,80€

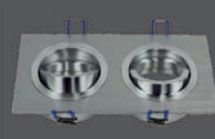

SL 50080-2

Aro Orient.Quad.Zamak Alumínio / IP 20  
Aro: 174x92mm  
Furo: 155x82mm  
Altura: 26mm  
Quant. Emb.20 pcs  
P.U. 28,30€



SL 50080-3

Aro Orient. Quad. Zamak  
Alumínio / IP 20  
Aro: 253x92mm  
Furo: 235x80mm  
Altura: 26mm  
Quant. Emb. 20 pcs  
**P.U. 42,10€**

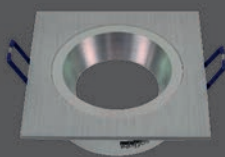

SL50080A-AL

Aro Fixo s/ Vidro  
Alumínio / IP 20  
Aro: 92mm  
Furo: 80mm  
Altura: 26mm  
Quant. Emb. 50 pcs  
**P.U. 13,80€**



SL 50091-WH

Aro Orient. Red. Zamak  
Branco / IP 20  
Aro: 92mm  
Furo: 78mm  
Altura: 40mm  
Quant. Emb. 50 pcs  
**P.U. 15,26€**



SL 50091-AL

Aro Orient. Red. Zamak  
Alumínio / IP 20  
Aro: 92mm  
Furo: 78mm  
Altura: 40mm  
Quant. Emb. 50 pcs  
**P.U. 15,53€**



SL 50091-1WH

Aro Orientável  
Branco / IP 20  
Aro: 90x90mm  
Furo: 78mm  
Altura: 40mm  
Quant. Emb. 50 pcs  
**P.U. 15,80€**

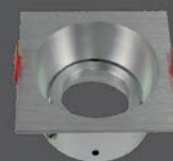

SL 50091-1AL

Aro Orientável  
Alumínio / IP 20  
Aro: 90x90mm  
Furo: 78mm  
Altura: 40mm  
Quant. Emb. 50 pcs  
**P.U. 16,10€**

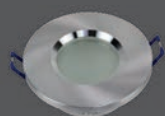

SL 50092-AL

Aro Red. c/Vidro Zamak  
Alumínio / IP 65  
Aro: 83mm  
Furo: 65mm  
Altura: 30mm  
Quant. Emb. 100 pcs  
**P.U. 11,50€**



SL 50092-SN

Aro Red. c/Vidro Zamak  
Aço escovado / IP 65  
Aro: 83mm  
Furo: 65mm  
Altura: 30mm  
Quant. Emb. 100 pcs  
**P.U. 12,00€**



SL 50092-WH

Aro Red. c/Vidro Zamak  
Branco / IP 65  
Aro: 83mm  
Furo: 65mm  
Altura: 30mm  
Quant. Emb. 100 pcs  
**P.U. 11,10€**



SL 50093-AL

Aro Quad. c/Vid. Zamak  
Alumínio / IP 65  
Aro: 83x83mm  
Furo: 65mm  
Altura: 30mm  
Quant. Emb. 100 pcs  
**P.U. 12,00€**



SL 50093-SN

Aro Quad. c/Vid. Zamak  
Aço Escovado / IP 65  
Aro: 83x83mm  
Furo: 65mm  
Altura: 30mm  
Quant. Emb. 100 pcs  
**P.U. 12,63€**



SL 50093-WH

Aro Quad. c/Vid. Zamak  
Branco / IP 65  
Aro: 83x83mm  
Furo: 65mm  
Altura: 30mm  
Quant. Emb. 100 pcs  
**P.U. 11,80€**

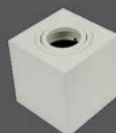

SL50080-WH.S

Projektor Quad. Saliente  
Branco / IP 20  
Aro: 95x95mm  
Altura: 90mm  
Quant. Emb. 20 pcs  
**P.U. 27,90€**

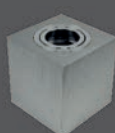

SL50080-AL.S

Projektor Quad. Saliente  
Alumínio / IP 20  
Aro: 95x95mm  
Altura: 90mm  
Quant. Emb. 20 pcs  
**P.U. 30,00€**



SL50081-WH.S

Projektor Red. Saliente  
Branco / IP 20  
Aro: 95mm  
Altura: 90mm  
Quant. Emb. 20 pcs  
**P.U. 25,80€**



SL50081-AL.S

Projektor Red. Saliente  
Alumínio / IP 20  
Aro: 95mm  
Altura: 90mm  
Quant. Emb. 20 pcs  
**P.U. 27,90€**



SL50060-GU10

Projektor c/ Vidro  
Aço Escovado / IP 40  
Aro: 90x90mm  
Furo: 80x80mm  
Altura: 120mm  
Quant. Emb. 50 pcs  
**P.U. 13,15€**



SL50070-GU10

Projektor s/ Vidro  
Aço Escovado / IP 20  
Aro: 90x90mm  
Furo: 84x84mm  
Altura: 140mm  
Quant. Emb. 50 pcs  
**P.U. 12,10€**



SL 50082-AL

Projektor Redondo  
Alumínio / IP 65  
Aro: 94mm  
Furo: 65mm  
Altura: 26mm  
Quant. Emb. 100 pcs  
**P.U. 14,42€**



SL 50083-AL

Projektor Quadrado  
Alumínio / IP 65  
Aro: 95x95mm  
Furo: 65x65mm  
Altura: 26mm  
Quant. Emb. 100 pcs  
**P.U. 14,95€**



SL 50090BR-GU10

Projektor c/ Vidro  
Branco / IP 65  
Aro: 100mm  
Furo: 80mm  
Altura: 95mm  
Quant. Emb. 50 pcs  
**P.U. 13,90€**



SL 50090CR-GU10

Projektor c/ Vidro  
Aço Escovado / IP 65  
Aro: 100mm  
Furo: 80mm  
Altura: 95mm  
Quant. Emb. 50 pcs  
**P.U. 15,26€**

Novos  
Produtos



SL50080-1P-BR

Aro Quadrado GU10  
Alumínio / IP20  
Aro: 125x125mm  
Altura: 30mm  
Cor: Branco  
Quant. Emb: 10 pcs  
P.U. 10,00€

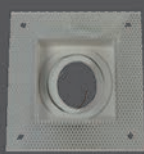

SL50080-1P-PT

Aro Quadrado GU10  
Alumínio / IP20  
Aro: 125x125mm  
Altura: 30mm  
Cor: Preto  
Quant. Emb: 10 pcs  
P.U. 10,00€



SL50081-1P-BR

Aro Redondo GU10  
Alumínio / IP20  
Aro: 125mm  
Altura: 30mm  
Cor: Branco  
Quant. Emb: 10 pcs  
P.U. 10,00€



SL50081-1P-PT

Aro Redondo GU10  
Alumínio / IP20  
Aro: 125mm  
Altura: 30mm  
Cor: Branco  
Quant. Emb: 10 pcs  
P.U. 10,00€



SL50081-GX-BR

Aro Redondo GX5,3  
Alumínio / IP20  
Aro: 105mm  
Altura: 25mm  
Cor: Branco  
Quant. Emb: 10 pcs  
P.U. 4,50€



SL50081-GX-PT

Aro Redondo GX5,3  
Alumínio / IP20  
Aro: 105mm  
Altura: 25mm  
Cor: Branco  
Quant. Emb: 10 pcs  
P.U. 4,50€

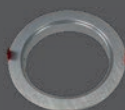

SL 50086-11

Aro Simples Redondo  
Alumínio / IP 20  
Aro: 178mm  
Furo: 150mm  
Altura: 30mm  
Quant. Emb.10 pcs  
P.U. 9,40€



SL 50086-1

Aro Simples Quadrado  
Alumínio / IP 20  
Aro: 180x180mm  
Furo: 150mm  
Altura: 25mm  
Quant. Emb.10 pcs  
P.U. 9,40€



SL 50086-2

Aro Duplo  
Alumínio / IP 20  
Aro: 340x180mm  
Furo: 310x150mm  
Altura: 25mm  
Quant. Emb.10 pcs  
P.U. 18,75€



SL 50086-3

Aro Triplo  
Alumínio / IP 20  
Aro: 495x180mm  
Furo: 465x150mm  
Altura: 25mm  
Quant. Emb.5 pcs  
P.U. 29,30€



SL 50086-4

Aro Quadruplo  
Alumínio / IP 20  
Aro: 340x360mm  
Furo: 310x330mm  
Altura: 25mm  
Quant. Emb.5 pcs  
P.U. 37,50€

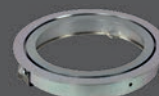

SL 50086-AR111

Acessório p/ AR111  
Alumínio / IP 20  
Aro: 140mm  
Altura: 60mm  
Quant. Emb.50 pcs  
P.U. 11,80€



SL 50086-PAR30

Acessório p/PAR30  
Alumínio / IP 20  
Aro: 140mm  
Altura: 140mm  
P.U. 15,30€



SL 90010

Suporte com Fio GU 5,3  
Quant. Emb: 1000  
P.U. 0,24€



SL 90020

Suporte com Fio GU 10  
Quant. Emb.: 100/1000  
P.U. 0,47€



SL 90030

Suporte com Fio GU 10  
com Chapa Classe II  
Quant. Emb.: 200  
P.U. 1,88€



SL 90050

Suporte com Fio GU 10  
com Ligador Repicagem  
Quant. Emb.: 200  
P.U. 2,30€

## Sensores de Movimento



SL-S20011

Detetor de Movimento  
220-240Vac - 180° - IP 44  
Distância Max. Detecção 12Mts  
Luz Ambiente: 3 a 2000 Lux  
Altura Instalação:1,5 a 2,5 mts  
P.U. 13,30€



SL-S20015

Detetor de Movimento  
220-240Vac - 180° - IP 65  
Distância Max. Detecção 12Mts  
Luz Ambiente: 3 a 2000 Lux  
Altura Instalação: 1,8 a 2,5 mts  
P.U. 15,80€

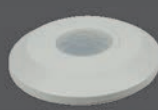

SL-S20005

Detetor de Movimento  
220-240Vac - 360° - IP 20  
Distância Max. Detecção 12Mts  
Luz Ambiente: 3 a 2000 Lux  
Alt. Instalação: 2,2 a 4 mts  
P.U. 13,30€



SL-S20040

Detetor de Movimento  
220-240Vac - 360° - IP 20  
Distancia Max. Detecção 12Mts  
Luz Ambiente: 3 a 2000 Lux  
Alt. Instalação: 2,2 a 4 mts  
P.U. 16,90€



SL-S20072

Aplique Muro com Sensor  
220-240Vac - 6000K - IP54  
10W-800lm  
Ajustável 3-2000 lux  
Dist. Detecção Max. 9 mts  
Inst. Altura 1,8 - 2,5 mts  
P.U. 25,90€



SL-S20053

Aplique Muro com Sensor  
220-240Vac - 6000K - IP54  
10W-800lm  
Ajustável 3-2000 lux  
Dist. Detecção Max. 9 mts  
Inst. Altura 1,8 - 2,5 mts  
P.U. 33,20€



ZM-12017

Sensor Movimento  
180° / 5-480s  
8mts / 1100W / IP 40  
Aro: 80x80mm  
Altura: 50mm  
Quant. Emb.70 pcs  
P.U. 13,50€



ZM-12085

Conjunto 3 Tom.c/ com.  
Quant. Emb.40 pcs  
P.U. 28,00€



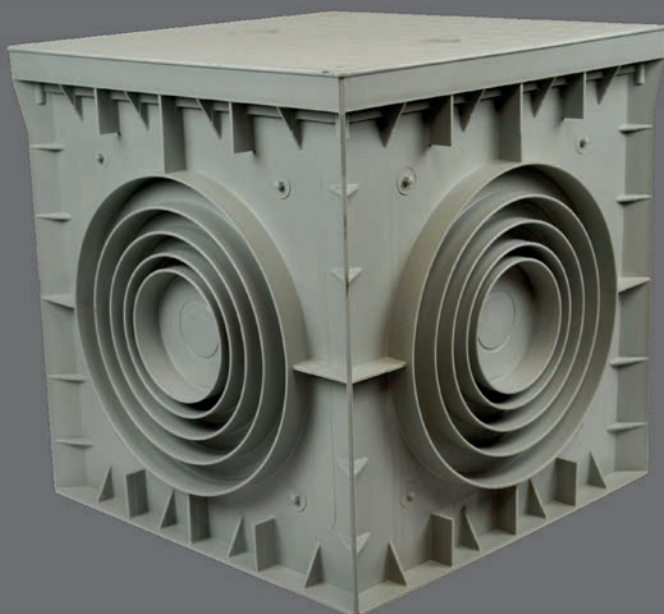

Código	Dimensões	Quant./Emb.	IK	IP	P.U.€
SL-09-200200200	200x200x200mm	1	IK 10	IP 20	10,00€
SL-09-300300300	300x300x300mm	1	IK 10	IP 20	24,50€
SL-09-400400400	400x400x400mm	1	IK 10	IP 20	46,00€
SL-09-550550500	550x550x500mm	1	IK 10	IP 20	110,00€

**SL-1814-84-BK**

Aplique Parede Orientável  
Alumínio: Cor Preto  
Difusor: PC  
LED CREE 1x7W  
IP 65 - 4000K  
**P.U. 110,00€**



40mm



116mm

180mm

**SL-1814-84-WH**

Aplique Parede Orientável  
Alumínio: Cor Branco  
Difusor: PC  
LED CREE 1X7W  
IP 65 - 4000K  
**P.U. 110,00€**

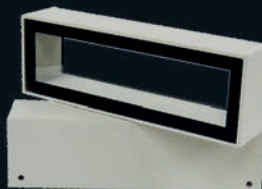

**SL-1882-84-BK**

Aplique Parede  
Alumínio: Cor Preto  
Difusor: PC  
LED CREE 1x6W  
IP 65 - 4000K  
**P.U. 80,00€**



34mm



102mm

160mm

**SL-1882-84-WH**

Aplique Parede  
Alumínio: Cor Branco  
Difusor: PC  
LED CREE 1x6W  
IP 65 - 4000K  
**P.U. 80,00€**



**SL-1951-BK**

Aplique Parede  
Alumínio: Cor Preto  
Difusor: PC  
2xGU 10 sem Lâmpada  
IP 65  
**P.U. 51,00€**



120mm



155mm

90mm

**SL-1951-WH**

Aplique Parede  
Alumínio: Cor Branco  
Difusor: PC  
2xGU 10 sem Lâmpada  
IP 65  
**P.U. 51,00€**



**SL-1961-BK**

Aplique Parede  
Alumínio: Cor Preto  
Difusor: PC  
2xGU 10 sem Lâmpada  
IP 65  
**P.U. 51,00€**



85mm



155mm

117mm

**SL-1961-WH**

Aplique Parede  
Alumínio: Cor Branco  
Difusor: PC  
2xGU 10 sem Lâmpada  
IP 65  
**P.U. 51,00€**





### SL-UFO-150W-54-PRO

Campânula UFO Led 150W  
100-300Vac - 50/60hz - 120°  
19500lm - 6500K - 30000h  
Uso Diário Aconselhável 12h  
**P.U. 140,00€**

## Campânula UFO ( 2 Anos Garantia )



### SL-UFO-200W-54-PRO

Campânula UFO Led 200W  
100-300Vac - 50/60hz - 120°  
26000lm - 6500K - 30000h  
Uso Diário Aconselhável 12h  
**P.U. 183,00€**

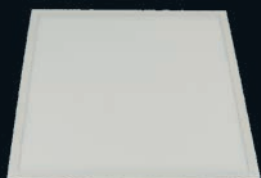

### SL-P60X60-40W-84

Painel Led 595x595mm  
100-277Vac - 4000K  
40W - 4000lm SMD 4014  
Quant. Caixa: 1  
**P.U. 56,00€**

## Painéis Led 40W ( 2 Anos Garantia )

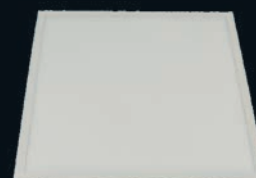

### SL-P60X60-40W-54

Painel Led 595x595mm  
100-277Vac - 6000K  
40W - 4000lm SMD 4014  
Quant. Caixa: 1  
**P.U. 56,00€**

## Projetores em Led Slim Série ECO (1 Ano Garantia)



**SL-FL-10W-54-ECO**

Projektor Led Slim 10W  
220Vac - 6000K  
Uso diário Max. 8h  
IP 65 - 1100lm  
Quant. Cx: 40pcs  
P.U. 6,30€



**SL-FL-20W-54-ECO**

Projektor Led Slim 20W  
220Vac - 6000K  
Uso diário Max. 8h  
IP 65 - 2200lm  
Quant. Cx: 20pcs  
P.U. 11,80€



**SL-FL-30W-54-ECO**

Projektor Led Slim 30W  
220Vac - 6000K  
Uso diário Max. 8h  
IP 65 - 3300lm  
Quant. Cx: 20pcs  
P.U. 17,70€



**SL-FL-50W-54-ECO**

Projektor Led Slim 50W  
220Vac - 6000K  
Uso diário Max. 8h  
IP 65 - 5500lm  
Quant. Cx: 20pcs  
P.U. 23,90€

## Projetores em Led Slim Série PRO (3 Anos Garantia Led OSRAM)



**SL-FL-20W-54-PRO**

Projektor Led Slim 20W  
220Vac - 6000K  
IP 65 - 2300lm  
Quant. Cx: 50pcs  
P.U. 21,40€



**SL-FL-30W-54-PRO**

Projektor Led Slim 30W  
220Vac - 6000K  
IP 65 - 3450lm  
Quant. Cx: 20pcs  
P.U. 28,850€



**SL-FL-50W-54-PRO**

Projektor Led Slim 50W  
220Vac - 6000K  
IP 65 - 5750lm  
Quant. Cx: 20pcs  
P.U. 44,50€



**SL-FL-100W-54-PRO**

Projektor Led Slim 100W  
220Vac - 6000K  
IP 65 - 11500lm  
Quant. Cx: 10pcs  
P.U. 77,700€



**SL-FL-20W-84-PRO**

Projektor Led Slim 20W  
220Vac - 4000K  
IP 65 - 2300lm  
Quant. Cx: 50pcs  
P.U. 21,40€



**SL-FL-30W-84-PRO**

Projektor Led Slim 30W  
220Vac - 4000K  
IP 65 - 3450lm  
Quant. Cx: 20pcs  
P.U. 28,85€



**SL-FL-50W-84-PRO**

Projektor Led Slim 50W  
220Vac - 4000K  
IP 65 - 5750lm  
Quant. Cx: 20pcs  
P.U. 44,50€



**SL-FL-150W-54-PRO**

Projektor Led Slim 150W  
220Vac - 6000K  
IP 65 - 17250lm  
Quant. Cx: 4pcs  
P.U. 124,00€

## Projetores em Led Slim Série-S PRO c/Sensor Movimento 2 Anos Garantia Led OSRAM



**SL-FL-200W-54-PRO**

Projektor Led Slim 200W  
220Vac - 6000K  
IP 65 - 23000lm  
Quant. Cx: 4pcs  
P.U. 150,00€



**SL-FL-20W-54-S-PRO**

Projektor Led Slim 20W  
220Vac - 6000K  
IP 65 - 2300lm  
Quant. Cx: 20pcs  
P.U. 41,30€



**SL-FL-30W-54-S-PRO**

Projektor Led Slim 30W  
220Vac - 6000K  
IP 65 - 3450lm  
Quant. Cx: 25pcs  
P.U. 49,15€



**SL-FL-50W-54-S-PRO**

Projektor Led Slim 50W  
220Vac - 6000K  
IP 65 - 5750lm  
Quant. Cx: 10pcs  
P.U. 70,20€



## Projetores Chão Led (sem Driver)

Led **CREE**



**SL040001-01-82**

Proj. Policarbonado, Led  
IP 67 - 120°  
2700K / 0,3W / 12Vdc  
Aro: 30mm  
Furo: 25mm  
Altura: 32mm  
Quant. Emb.50 pcs  
**P.U. 17,00€**



**SL040001-01-84**

Proj. Policarbonado, Led  
IP 67 - 120°  
4200K / 0,3W / 12Vdc  
Aro: 30mm  
Furo: 25mm  
Altura: 32mm  
Quant. Emb.50 pcs  
**P.U. 17,00€**



**SL040001-02-82**

Proj. Policarbonado, Led  
IP 67 - 120°  
2700K / 0,3W / 12Vdc  
Aro: 40mm  
Furo: 30mm  
Altura: 32mm  
Quant. Emb.50 pcs  
**P.U. 23,80€**



**SL040001-02-84**

Proj. Policarbonado, Led  
IP 67 - 120°  
4200K / 0,3W / 12Vdc  
Aro: 40mm  
Furo: 30mm  
Altura: 32mm  
Quant. Emb.50 pcs  
**P.U. 23,80€**



**SL040002-01-82**

Projektor Inox 316 Led  
IP 68 - 38°  
2700K / 0,6W / 12Vdc  
Aro: 30mm  
Furo: 25mm  
Altura: 27mm  
Quant. Emb.50 pcs  
**P.U. 31,50€**



**SL040002-01-84**

Projektor Inox 316 Led  
IP 68 - 38°  
4200K / 0,6W / 12Vdc  
Aro: 30mm  
Furo: 25mm  
Altura: 27mm  
Quant. Emb.50 pcs  
**P.U. 31,50€**



**SL040004-01-82**

Projektor Inox 316 Led  
IP 68 - 120°  
2700K / 1W / 12Vdc  
Aro: 35mm  
Furo: 28mm  
Altura: 32mm  
Quant. Emb.50 pcs  
**P.U. 37,00€**



**SL040004-01-84**

Projektor Inox 316 Led  
IP 68 - 120°  
4200K / 1W / 12Vdc  
Aro: 35mm  
Furo: 28mm  
Altura: 32mm  
Quant. Emb.50 pcs  
**P.U. 37,00€**

Projetores Chão Led (sem Driver)



SL040002-02-82

Projektor Inox 316 Led  
IP 68 - 38°  
2700K / 2,5W / 12Vdc  
Aro: 45mm  
Furo: 36mm  
Altura: 54mm  
Quant. Emb.50 pcs  
**P.U. 80,00€**



SL040002-02-84

Projektor Inox 316 Led  
IP 68 - 38°  
4200K / 2,5W / 12Vdc  
Aro: 45mm  
Furo: 36mm  
Altura: 54mm  
Quant. Emb.50 pcs  
**P.U. 80,00€**



SL040002-02-RGB

Projektor Inox 316 Led  
IP 68 - 38°  
RGB/2,5W/12Vdc  
Aro: 45mm  
Furo: 36mm  
Altura: 54mm  
Quant. Emb.50 pcs  
**P.U. 113,00€**



SL040003-01-82

Projektor Inox 316 Led  
1 Direção / IP 68  
2700K/40°/1,2W/12Vdc  
Aro: 45mm  
Furo: 36mm  
Altura: 54mm  
Quant. Emb.50 pcs  
**P.U. 66,00€**



SL040003-01-84

Projektor Inox 316 Led  
1 Direção / IP 68  
4200K/40°/1,2W/12Vdc  
Aro: 45mm  
Furo: 36mm  
Altura: 54mm  
Quant. Emb.50 pcs  
**P.U. 66,00€**



SL040003-02-82

Projektor Inox 316 Led  
2 Direções / IP 68  
2700K/40°/2,5W/12Vdc  
Aro: 45mm  
Furo: 36mm  
Altura: 54mm  
Quant. Emb.50 pcs  
**P.U. 87,00€**



SL040003-02-84

Projektor Inox 316 Led  
2 Direções / IP 68  
4200K/40°/2,5W/12Vdc  
Aro: 45mm  
Furo: 36mm  
Altura: 54mm  
Quant. Emb.50 pcs  
**P.U. 87,00€**



SL040005-01-82

Projektor Inox 316 Led  
2 Vias - IP 67  
2700K / 1,5W / 12Vdc  
Diam: 86mm  
Altura: 18mm  
Com. Cabo: 50cm  
Quant. emb. 100 pcs  
**P.U. 91,00€**



SL040006-01-82

Projektor Inox 316 Led  
4 Vias - IP 67  
2700K / 1,5W / 12Vdc  
Diam: 86mm  
Altura: 18mm  
Com. Cabo: 50cm  
Quant. emb. 100 pcs  
**P.U. 91,00€**

SL040005-01-84

Projektor Inox 316 Led  
2 Vias - IP 67  
4200K / 1,5W / 12Vdc  
Diam: 86mm  
Altura: 18mm  
Com. Cabo: 50cm  
Quant. emb. 100 pcs  
**P.U. 91,00€**

SL040006-01-84

Projektor Inox 316 Led  
4 Vias - IP 67  
4200K / 1,5W / 12Vdc  
Diam: 86mm  
Altura: 18mm  
Com. Cabo: 50cm  
Quant. emb. 100 pcs  
**P.U. 91,00€**

Projetores p/ DECK Led, INOX 316



## Fita Led Serie Pro

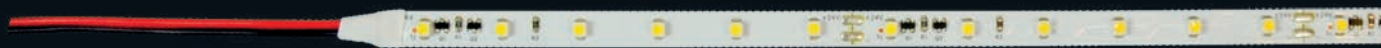

### SL-F010-006-54-PRO

Rolo Fita Led 5mm  
24Vdc - 6W  
IP 20  
6500K  
Rolo c/ 5mts  
P.U. 37,00€

### SL-F010-006-82-PRO

Rolo Fita Led 5mm  
24Vdc - 6W  
IP 20  
3000K  
Rolo c/ 5mts  
P.U. 37,00€

### SL-F010-006-84-PRO

Rolo Fita Led 5mm  
24Vdc - 6W  
IP 20  
4000K  
Rolo c/ 5mts  
P.U. 37,00€

### SL-F010-010-54-PRO

Rolo Fita Led 8mm  
24Vdc - 6W  
IP 20  
6500K  
Rolo c/ 5mts  
P.U. 41,00€

### SL-F010-010-82-PRO

Rolo Fita Led 8mm  
24Vdc - 6W  
IP 20  
3000K  
Rolo c/ 5mts  
P.U. 41,00€

### SL-F010-010-84-PRO

Rolo Fita Led 8mm  
24Vdc - 6W  
IP 20  
4000K  
Rolo c/ 5mts  
P.U. 41,00€

### SL-F010-006-54-WPRO

Rolo Fita Led 5mm  
24Vdc - 6W  
IP 65  
6500K  
Rolo c/ 5mts  
P.U. 74,00€

### SL-F010-006-82-WPRO

Rolo Fita Led 5mm  
24Vdc - 6W  
IP 65  
3000K  
Rolo c/ 5mts  
P.U. 74,00€

### SL-F010-006-84-WPRO

Rolo Fita Led 5mm  
24Vdc - 6W  
IP 65  
4000K  
Rolo c/ 5mts  
P.U. 74,00€

### SL-F010-010-54-WPRO

Rolo Fita Led 8mm  
24Vdc - 6W  
IP 65  
6500K  
Rolo c/ 5mts  
P.U. 82,00€

### SL-F010-010-82-WPRO

Rolo Fita Led 8mm  
24Vdc - 6W  
IP 65  
3000K  
Rolo c/ 5mts  
P.U. 82,00€

### SL-F010-010-84-WPRO

Rolo Fita Led 8mm  
24Vdc - 6W  
IP 65  
4000K  
Rolo c/ 5mts  
P.U. 82,00€

## Fita Led Série PRO ( 5 Anos Garantia )



### SL-F01010-82-PRO

Rolo Fita Led com  
Corrente Constante 24Vdc  
Com 60 Led 2835  
Pcb 8mm - 4,8W/mt  
3000K  
Quant. Mt / Rolo: 10mts  
P.U. 74,00€

### SL-F01010-84-PRO

Rolo Fita Led com  
Corrente Constante 24Vdc  
Com 60 Led 2835  
Pcb 8mm - 4,8W/mt  
4000K  
Quant. Mt / Rolo: 10mts  
P.U. 74,00€

### SL-F01010-54-PRO

Rolo Fita Led com  
Corrente Constante 24Vdc  
Com 60 Led 2835  
Pcb 8mm - 4,8W/mt  
6000K  
Quant. Mt / Rolo: 10mts  
P.U. 74,00€



### SL-F01020-82-PRO

Rolo Fita Led com  
Corrente Constante 24Vdc  
Com 60 Led 2835-3000K  
Pcb 10mm - 11,5W/mt  
Quant. Mt / Rolo: 10mts  
P.U. 103,30€

### SL-F01050-82/54-PRO

Rolo Fita Led com  
Corrente Constante 24Vdc  
Com 120 Led 2216  
Pcb 8mm - 10W/mt  
3000K+6000K  
Quant. Mt / Rolo: 5mts  
P.U. 56,00€

### SL-F01020-54-PRO

Rolo Fita Led com  
Corrente Constante 24Vdc  
Com 60 Led 2835-3000K  
Pcb 10mm - 11,5W/mt  
Quant. Mt / Rolo: 10mts  
P.U. 103,30€

### SL-F01020-54-ECO

Rolo Fita Led com  
Corrente Constante 12Vdc  
Com 120 Led 2835-6000K  
Pcb 10mm - 9,6W/mt  
Uso diário Max. 8 Horas  
Quant. Mt / Rolo: 5mts  
P.U. 18,50€

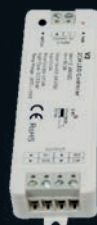

### SL-CONTROL-W/WW

Controlador para fita Led  
Para Fita W/WW

P.U. 43,00€



**SL - CONTROL-01**

Controlador  
RGB - 1A / Canal  
3A  
**P.U. 30.00€**



**SL - CONTROL-02**

Controlador  
RGB - 6A / Canal  
18A  
**P.U. 71.00€**



**SL - CONTROL-03**

Controlador  
RGB - 10A / Canal  
30A  
**P.U. 101.00€**



**SL - AMPLIFIER**

Amplificador RGD  
12Vdc / IP 20  
12A  
**P.U. 55.00€**

**Fitas Led** ( válido para Stock existente )



**SL - FITA-20W**

Rolo (5mts) Fita 30Led  
7,2W / mt / 6400K  
215 lm/mt/IP 63/12Vdc  
**P.U. 53.30€**

**SL - FITA-20WW**

Rolo (5mts) Fita 30Led  
7,2W / mt / 2700K  
215 lm/mt/IP 63/12Vdc  
**P.U. 53.30€**

**SL-FITA-20RGB**

Rolo (5mts) Fita 30Led  
7,2W / mt / RGB  
215 lm/mt/IP 63/12Vdc  
**P.U. 53.30€**



**SL - FITA-30W**

Rolo (5mts) Fita 60Led  
14,4W / mt / 6400K  
265 lm/mt/IP 63/12Vdc  
**P.U. 88.90€**

**SL - FITA-30WW**

Rolo (5mts) Fita 60Led  
14,4W / mt / 2700K  
265 lm/mt/IP 63/12Vdc  
**P.U. 88.90€**

**SL - FITA-30-RGB**

Rolo (5mts) Fita 60Led  
14,4W / mt / RGB  
265 lm/mt/IP 63/12Vdc  
**P.U. 88.90€**

**SL - FITA-11W**

Rolo (5mts) Fita 60Led  
4,8W / mt / 6400K  
107 lm/mt/IP 20/12Vdc  
**P.U. 8.90€**

**SL - FITA-11WW**

Rolo (5mts) Fita 60Led  
4,8W / mt / 2700K  
107 lm/mt/IP 20/12Vdc  
**P.U. 8.90€**



**SL - FITA-21W**

Rolo (5mts) Fita 30Led  
7,2W / mt / 6400K  
215 lm/mt/IP 20/12Vdc  
**P.U. 10.10€**

**SL - FITA-21WW**

Rolo (5mts) Fita 30Led  
7,2W / mt / 2700K  
215 lm/mt/IP 20/12Vdc  
**P.U. 10.10€**

**SL-FITA-21-RGB**

Rolo (5mts) Fita 30Led  
7,2W / mt / RGB  
215 lm/mt /IP 20/12Vdc  
**P.U. 10.10€**

**SL - FITA-31W**

Rolo (5mts) Fita 60Led  
14,4W / mt / 6400K  
255 lm/mt/IP 20/12Vdc  
**P.U. 10.10€**

**SL - FITA-31-RGB**

Rolo (5mts) Fita 60Led  
14,4W / mt / RGB  
215 lm/mt/IP 20/12Vdc  
**P.U. 10.10€**



**SL - FITA-BR04**

Rolo (5mts) Fita 60Led  
107 lm/mtIP65/12Vdc

Rolo (5mts) Fita 60Led  
4,8W / mt / 2700K  
107 lm/mtIP65/12Vdc  
**P.U. 23.00€**

**SL - FITA-RGB01**

Rolo (5mts) Fita 30Led  
7,2W / mt / RGB  
215 lm/mtIP65/12Vdc  
**P.U. 23.00€**

**SL - FITA-100-10WW**

Barra Led Alumínio 9,6W  
2700K / 12Vdc  
Dim.1000x11mm  
**P.U. 13.00€**



**SL - FITA-050-30W**

Barra Led Alumínio 9,6W  
6400K / 12Vdc IP 20  
Dim.500x12mm  
**P.U. 9.70€**

**SL - FITA-050-30WW**

Barra Led Alumínio 9,6W  
2700K / 12Vdc IP 20  
Dim.500x12mm  
**P.U. 9.70€**

**SL-FITA-RGB+W**

Fita RGB - 6400K  
12Vdc / 9,6W / IP 20  
**P.U. 58.00€**

**SL-FITA-RGB+WW**

Fita RGB-2700K/9,6W  
12Vdc / 9,6W / IP 20  
**P.U. 58.00€**



# Fitas de Neon



## Fita Neon Série PRO ( 3 Anos Garantia )



8W/lm - 650lm



### SL-FN0508-84-PRO

Fita Neon 05x08mm  
4000K - 24Vdc  
8W/lm - 650lm  
IP 65 - Led 2835  
Quant. Mt / Rolo: 100mts  
**P.U. 28,30€/ mt**

### SL-FN0511-84-PRO

Fita Neon 05x11mm  
4000K - 24Vdc  
11W/m - 500lm/m  
IP 67 - Led 2835  
Quant. Mt / Rolo: 100mts  
**P.U. 22,50€/ mt**

### SL-FN0812-84-PRO

Fita Neon 08x12mm  
4000K - 24Vdc  
11W/m - 650lm/m  
IP 67 - Led 2835  
Quant. Mt / Rolo: 100mts  
**P.U. 28,50€/ mt**

### SL-FN1010-84-PRO

Fita Neon 10x10mm  
4000K - 24Vdc  
11W/m - 900lm/m  
IP 67 - Led 2835  
Quant. Mt / Rolo: 100mts  
**P.U. 39,90€/ mt**

### SL-FN1717-84-PRO

Fita Neon 17x17mm  
4000K - 24Vdc  
11W/m - 900lm/m  
IP 67 - Led 2835  
Quant. Mt / Rolo: 100mts  
**P.U. 43,95€/ mt**



### SL-TR-01

Transformador, IP 20  
100-240Vac / 12Vdc  
2,1A / 25W  
84x58x38mm  
**P.U. 14,30€**



### SL-TR-02

Transformador, IP 20  
100-240Vac / 12Vdc  
4,16A / 50W  
110x78x35mm  
**P.U. 20,60€**

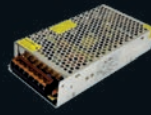

### SL-TR-03

Transformador, IP 20  
100-240Vac / 12Vdc  
8,33A / 100W  
159x98x38mm  
**P.U. 29,90€**

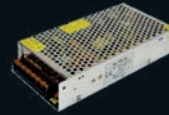

### SL-TR-04

Transformador, IP 20  
100-240Vac / 12Vdc  
12,5A / 150W  
198x98x38mm  
**P.U. 35,80€**

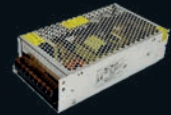

### SL-TR-05

Transformador, IP 20  
100-240Vac / 12Vdc  
20A / 250W  
200x110x50mm  
**P.U. 51,50€**

### SL-TR-01-24V

Transformador, IP 20  
100-240Vac / 24Vdc  
1,04A / 25W  
84x58x38mm  
**P.U. 14,30€**

### SL-TR-02-24V

Transformador, IP 20  
100-240Vac / 24Vdc  
2,08A / 50W  
110x78x35mm  
**P.U. 20,60€**

### SL-TR-03-24V

Transformador, IP 20  
100-240Vac / 24Vdc  
4,16A / 100W  
159x98x38mm  
**P.U. 29,90€**

### SL-TR-04-24V

Transformador, IP 20  
100-240Vac / 24Vdc  
6,2A / 150W  
198x98x38mm  
**P.U. 35,80€**

### SL-TR-05-24V

Transformador, IP 20  
100-240Vac / 24Vdc  
10A / 250W  
200x110x50mm  
**P.U. 51,50€**

## Calha 3 Fases Alumínio



Código	Descrição	Comp.	Larg.	Alt.	Cor	Preço
SL-C410-1WH	Calha 3 Fases	1 mt	35mm	38mm	Branca	39,00€
SL-C410-1BK	Calha 3 Fases	1 mt	35mm	38mm	Preta	39,00€
SL-C410-2WH	Calha 3 Fases	2 mt	35mm	38mm	Branca	78,30€
SL-C410-2BK	Calha 3 Fases	2 mt	35mm	38mm	Preta	78,30€
SL-C410-3WH	Calha 3 Fases	3 mt	35mm	38mm	Branca	117,00€
SL-C410-3BK	Calha 3 Fases	3 mt	35mm	38mm	Preta	117,00€



SL-C440-WH

Adaptador p/ Calha Branco  
P.U. 11,60€



SL-C0431-L-WH

Alimentador Esquerdo Branco  
P.U. 14,70€



SL-C0431-R-WH

Alimentador Direito Branco  
P.U. 14,70€



SL-C0432-WH

Topo Branco  
P.U. 8,70€



SL-C0433-WH

União Curta Branco  
P.U. 27,00€

SL-C0440-BK

Adaptador p/ Calha Preto  
P.U. 11,60€

SL-C0431-L-BK

Alimentador Esquerdo Preto  
P.U. 14,70€

SL-C0431-R-BK

Alimentador Direito Preto  
P.U. 14,70€

SL-C0432-BK

Topo Preto  
P.U. 8,70€

SL-C0433-BK

União Curta Preto  
P.U. 27,00€



SL-C0434-WH

União / Aliment. Central Branco  
P.U. 33,70€



SL-C0435-L-WH

Curva 90° Esquerda Branco  
P.U. 27,00€



SL-C0435-R-WH

Curva 90° Direita Branco  
P.U. 27,00€



SL-C0436-L1-WH

Derivação «T» Esq. Branco  
P.U. 35,00€



SL-C0436-L2-WH

Derivação «T» Esq. Branco  
P.U. 35,00€

SL-C0434-BK

União / Aliment. Central Preto  
P.U. 33,70€

SL-C0435-L-BK

Curva 90° Esquerda Preto  
P.U. 27,00€

SL-C0435-R-BK

Curva 90° Direita Preto  
P.U. 27,00€

SL-C0436-L1-BK

Derivação «T» Esq. Preto  
P.U. 35,00€

SL-C0436-L2-BK

Derivação «T» Esq. Preto  
P.U. 35,00€



**SL-C0436-R1-WH**

Derivação «T» Direita. Branco

**P.U. 35,00€**



**SL-C0436-R2-WH**

Derivação «T» Direita Branco

**P.U. 35,00€**



**SL-C0437-WH**

Derivação «+» Direita Branco

**P.U. 43,50€**



**SL-C0447-WH**

Suspensão Varão 1mt Branco

**P.U. 23,50€**



**SL-C0448-WH**

Susp. Cabo d' aço 1mt Branco

**P.U. 13,50€**



**SL-C0436-R1-BK**

Derivação «T» Direita. Preto

**P.U. 35,00€**



**SL-C0436-R2-BK**

Derivação «T» Direita Preto

**P.U. 35,00€**



**SL-C0437-BK**

Derivação «+» Direita Preto

**P.U. 43,50€**



**SL-C0447-BK**

Suspensão Varão 1mt Preto

**P.U. 23,50€**



**SL-C0448-BK**

Susp. Cabo d' aço 1mt Preto

**P.U. 13,50€**



**SL-C0449-WH**

Adaptador Mecânico Branco

**P.U. 35,00€**



**SL-CSK-WH**

Suporte Fixação Branco

**P.U. 6,50€**



**SL-CB5002-WH**

Caixa Vazia p/Driver Branca

**P.U. 40,00€**

**3 Anos Garantia**



**SL-C8268-84-WH**

Proj.p/Calha, s/Adapt. LED. Branco  
4200K/20W/3000lm

**P.U. 110,00€**



**SL-C0449-BK**

Adaptador Mecânico Preto

**P.U. 35,00€**



**SL-CSK-BK**

Suporte Fixação Preto

**P.U. 6,50€**



**SL-CB5002-BK**

Caixa Vazia p/Driver Preta

**P.U. 40,00€**

## 1 Ano Garantia



**SL-TL-30W-D-WH**

Projektor Calha Branco  
4000K-38°-30W Led  
3000lm  
Quant.Embalagem: 1pcs  
**P.U. 86,20€**



**SL80011BR**

Projektor Simples c/Base  
Suporte GU10  
Sem Lâmpada  
Cor: Branco  
**P.U. 17,50€**



**SL80012BR**

Projektor Duplo c/Base  
Suporte GU10  
Sem Lâmpadas  
Cor: Branco  
**P.U. 33,70€**



**SL80013BR**

Projektor Triplo c/Base  
Suporte GU10  
Sem Lâmpadas  
Cor: Branco  
**P.U. 51,60€**



**SL-TL-30W-D-BK**

Projektor Calha Preto  
4000K-38°-30W Led  
3000lm  
Quant.Embalagem: 1pcs  
**P.U. 86,20€**



**SL80011PT**

Projektor Simples c/Base  
Suporte GU10  
Sem Lâmpada  
Cor: Preto  
**P.U. 17,50€**



**SL80012PT**

Projektor Duplo c/Base  
Suporte GU10  
Sem Lâmpadas  
Cor: Preto  
**P.U. 33,70€**



**SL80013PT**

Projektor Triplo c/Base  
Suporte GU10  
Sem Lâmpadas  
Cor: Preto  
**P.U. 51,60€**

# Lâmpada de Led



**SL-G45-5W-84-E14**

Lâmpada G45-5W-E14  
400lm 4000K  
Quant. Caixa: 100pcs  
**P.U. 2,25€**



**SL-G45-7W-84-E14**

Lâmpada G45-7W-E14  
560lm 4000K  
Quant. Caixa: 100pcs  
**P.U. 2,50€**



**SL-G45-5W-54-E27**

Lâmpada G45-5W-E27  
400lm 6000K  
Quant. Caixa: 100pcs  
**P.U. 2,25€**



**SL-G45-7W-54-E27**

Lâmpada G45-7W-E27  
560lm 6000K  
Quant. Caixa: 100pcs  
**P.U. 2,45€**



**SL-A60-F-6W-82-E27**

Lâmpada A60-6W-E27  
600lm 3000K  
Quant. Caixa: 100pcs  
**P.U. 3,85€**

**SL-G45-5W-54-E14**

Lâmpada G45-5W-E14  
400lm 6000K  
Quant. Caixa: 100pcs  
**P.U. 2,25€**

**SL-G45-7W-54-E14**

Lâmpada G45-7W-E14  
560lm 6000K  
Quant. Caixa: 100pcs  
**P.U. 2,50€**



**SL-G9-6W-84**

Lâmpada G9-6W  
400lm 4000K  
Quant. Caixa: 100pcs  
**P.U. 3,65€**



**SL-G9-10W-84**

Lâmpada G9-10W  
700lm 4000K  
Quant. Caixa: 100pcs  
**P.U. 5,50€**



**SL-C37-5W-84-E14**

Lâmpada C37-5W-E14  
400lm 4000K  
Quant. Caixa: 100pcs  
**P.U. 2,25€**



**SL-C37-5W-54-E14**

Lâmpada C37-5W-E14  
400lm 6000K  
Quant. Caixa: 100pcs  
**P.U. 2,25€**



**GL-05-310-WW**

Lâmpada Led E14  
3W / 18SMD  
2700K  
**P.U. 2,20€**



**GL-05-310-W**

Lâmpada Led E14  
3W / 18SMD  
6500k  
**P.U. 2,20€**



**GL-05-410-WW**

Lâmpada Led E27  
3W / 48SMD  
2700K  
**P.U. 2,50€**



**GL-05-410-W**

Lâmpada Led E27  
3W / 48SMD  
6000K  
**P.U. 2,50€**



**SL-GU10-7W-54**

Lâmpada GU 10 - 7W  
520lm 6000K  
Quant. Caixa: 100pcs  
**P.U. 2,65€**



**GL05-SMD24D-82**

Lâmpada Led 24 SMD  
4,5W 120V 230V  
2700K / 410lm  
**P.U. 1,80€**



**GL-05-060W-82**

Lâmpada Led GU 10  
6W / 36° 2700K  
450Lm  
**P.U. 2,90€**



**GL-05-RGB-DMX**

Lâmpada Led 5W  
RGB 12vDC  
**P.U. 50,00€**



**GL-05-PAR38-18W**

Lâmpada Led PAR 38  
18W / 4200K  
800Lm  
**P.U. 32,00€**



**GL-05-R50-030**

Lâmpada Led E14  
3W / 6500K  
200Lm  
**P.U. 5,50€**



**GL-05-R63-045W**

Lâmpada Led E27  
4,5W / 6500K  
300Lm  
**P.U. 6,85€**



**SL-L-GX53-6W-84**

Lâmpada GX 53  
6W - 4000K  
540lm  
**P.U. 4,50€**



**SL-S-GX53**

Suporte GX 53  
**P.U. 1,05€**



**SL - S110-10W-54**

Projektor Led 10W.  
120° / 6000K / 900lm  
Dim.115x88x78mm  
**P.U 2.25€**



**SL - S110-20W-82**

Projektor Led 20W.  
120° / 4000K / 2000lm  
Dim.181x140x100mm  
**P.U 6.70€**



**SL - S110-30W-54**

Projektor Led 30W.  
120° / 6000K / 3000lm  
Dim.225x186x124mm  
**P.U 10.00€**

**SL - S110-10W-82**

Projektor Led 10W.  
120° / 4000K / 900lm  
Dim.115x88x78mm  
**P.U 2.25€**

**SL - S110-30W-82**

Projektor Led 30W.  
120° / 4000K / 3000lm  
Dim.225x186x124mm  
**P.U 10.00€**



olympia<sup>TM</sup>  
electronics  
SAFETY & SECURITY SYSTEMS

*for a safer world!*

## Safety & Security Systems



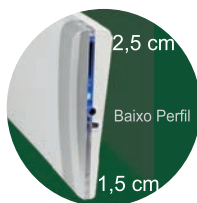

Baixo perfil  
Sensor Luz  
Auto - Teste

Fácil Instalação  
Controlo Remoto  
Permanente e Não Permanente



Conjunto de 3  
Tampas incluídas

Armadura Emergência SLIM LEDs LIGH™

MODELO	DESCRIÇÃO	PREÇO	IP 20
GR-2000	Permanente/Não- Permanente/LEDs-110/110lm Autonomia 3 a 7 horas	124,00€	
IRT-200	RC-15A IR Controlo Remoto para Armadura GR-2000 (38KHZ)	23,00€	

\*GR-2000 Registado para WIPO No. DM/ 074 490



GR-82/230VA/82NI	Não Permanente 3,6V/120mA Led -20lm / 3h	36,00€
------------------	--	--------



GR-82/230VA/82W/SQ	Não Permanente Fluoreceste 6W - 50lm / 1.5h	36,00€
--------------------	---	--------

Armaduras em LEDs "SLIM LEDs LIGHT"

MODELO	DESCRIÇÃO	PREÇO	IP 20
GR-8/Led/R	Perm. / Não perm. / LEDs - 40/100lm / 1.5h	35,00€	



GR-8/2I/R	Não perm. / LEDs - 50lm / 2h	32,00€	
-----------	------------------------------	--------	--



GR-310/12L/90R	Perm. / Não perm. / LEDs - 35/75lm / 1.5h	54,80€	IP 40
----------------	---	--------	-------

GR-310/12L/180R	Perm. / Não perm. / LEDs - 35/75lm / 3h	75,20€	
-----------------	---	--------	--

GR-310/30/L/R	Não perm. / LEDs - 210lm / 1.5h	81,20€	
---------------	---------------------------------	--------	--

GR-312/30/L/R	Não perm. / LEDs - 210lm / 3h	170,20€	
---------------	-------------------------------	---------	--

GR-315/15/L/R	Permanente / LEDs - 105lm / 1.5h	97,70€	
---------------	----------------------------------	--------	--

GR-315/30/L/R	Permanente / LEDs - 210lm / 3h	123,50€	
---------------	--------------------------------	---------	--



GR-1935/15L/R	Permente / Não Permanente Led 40/105lm 1.5h IP 65	85,50€	IP 65
---------------	---	--------	-------

GR-935/15/L/R	Não-Permanente / LEDs - 105lm / 1.5h	94,50€	
---------------	--------------------------------------	--------	--

GR-935/4P/R	Não-Permanente / LEDs - 250lm / 1.5h	180,50€	
-------------	--------------------------------------	---------	--



GR-938/15L/R	Permanente / LEDs - 105lm / 1.5h	122,50€	
--------------	----------------------------------	---------	--

GR-938/30L/R	Permanente / LEDs - 210lm / 1.5h	147,50€	
--------------	----------------------------------	---------	--



GR-8/R	Não Permanente Fluoreceste 6W - 50lm / 1.5h	16,50€	
--------	---	--------	--



GR-410/R	Não Permanente Fluorescente 8W - 85lm / 1.5h	21,80€	
----------	--	--------	--



GR-4/UN65	Kit emergencia para Lâmpada T5 / T8 1.5h	53,50€	
-----------	--	--------	--

GR-51/A	Telecomando até 100 Armaduras Inibit	96,50€	
---------	--------------------------------------	--------	--



LEDs de alto rendimento  
Longa duração do LED (100.000 horas)  
Design elegante  
Sinais direcção podem ser aplicados p/ utilizador

Fabricado de acordo com: EN 60598-1,  
EN60598-2-22, EN 1836  
Instalação em tecto falso utilizando base especial  
Temperatura de funcionamento: 0 a 40° C

As sinaléticas usam tecnologia amiga do ambiente.

SINALÉTICA (dupla face) com fundo verde e LEDs brancos da série "ECO LIGHT"

95,00€

MODELO	DESCRIÇÃO	DIMENSÕES (CxLxA)	CÓDIGO	PREÇO
MLD-28D/w	Sinalética, permanente / 12 LEDs - 72/72lm, 3h.	283x130x25mm	922502811	95,00€
MLD-28D/w/90	Sinalética, permanente / 12 LEDs - 72/72lm, 90min.	283x130x25mm	922502827	95,00€
MLD-34D/w	Sinalética, permanente / 15 LEDs - 90/90lm, 3h.	343x200x25mm	922503426	186,00€
MLD-44D/w	Sinalética, permanente / 15 LEDs - 90/90lm, 3h.	443x250x25mm	922504417	228,00€

IP 40



SINALÉTICA (dupla face) com fundo transparente e LEDs verdes da série "ECO LIGHT"

MODELO	DESCRIÇÃO	DIMENSÕES (CxLxA)	CÓDIGO	PREÇO
MLD-28S/G/R	Sinalética, permanente / LEDs - 18/18lm / 3h.	283x130x25mm	922502800	128,00€
MLD-28S/G/90/R	Sinalética, permanente / LEDs - 18/18lm / 90min.	283x130x25mm	922502826	92,00€
MLD-34S/G/R	Sinalética, permanente / LEDs - 18/22lm / 3h.	343x200x25mm	922503400	174,00€
MLD-44S/g	Sinalética, permanente / LEDs - 18/22lm / 3h.	443x250x25mm	922504400	207,00€

IP 40



ACESSÓRIOS PARA ARMADURAS "ECO LIGHT" ( mediante encomenda)

MODELO	DESCRIÇÃO	CÓDIGO	PREÇO
A-1022	Kit para instalação em tecto para 20 cm distância	927102200	59,00€
A-1025	Kit para instalação em tecto para 40 cm distância	927102500	66,60€
A-1026	Kit para instalação em tecto para 60 cm distância	927102600	91,00€
A-1027	Kit para instalação em tecto com corrente até 50 cm	927102700	9,20€
A-1018	Base de encastrar apropriada para MLD28, DLD 28	980210180	32,20€
A-1020	Base de encastrar apropriada para MLD 34, DLD 34	980210200	41,40€

IP 40



\* Acessórios incluídos na embalagem.  
apropriados para montagem em tecto  
e parede



Foram projectadas para áreas onde é necessário iluminação de alto rendimento ou autonomia máxima.  
As lanternas GR-21/H3 são armaduras emergência estanques(IP65), caixa com pintura electrostática, duas lâmpadas de 55W e 3 horas de autonomia

LANTERNA EMERGÊNCIA DE ALTO RENDIMENTO da série "POWER LIGHT"

MODELO	DESCRIÇÃO	CÓDIGO	PREÇO
GR-21/R	Não-permanente/halogéneo 2x20W-700 lm, 90min.	923021000	168,50€
GR-21/H/R	Não-permanente/halogéneo 2x55W-2400 lm, 60min.	923021001	499,50€

IP 42



LANTERNA EMERGÊNCIA ESTANQUE Led

MODELO	DESCRIÇÃO	CÓDIGO	PREÇO
GRL-21/R	Lanterna Emerg.Não-perma./Led 790lm 1m1.5h	923021011	182,50€

IP 42



LANTERNA EMERGÊNCIA ESTANQUE (IP65) DE ALTO RENDIMENTO da série "POWER LIGHT"

MODELO	DESCRIÇÃO	CÓDIGO	PREÇO
GR-32/R	Estanques,não-perma./halogéneo 2x55W-2400 lm, 60min.	923032000	537,50€

IP 65



## ELECTROCUTORES DE INSECTOS COM GRELHA ALTA VOLTAGEM



olympia<sup>TM</sup>  
electronics

SAFETY & SECURITY SYSTEMS

Design moderno  
Instalação fácil  
Dois modelos portáteis (RT-11, RT-12)  
Uma gama completa de modelos profissionais para áreas de grandes dimensões  
Modelos especiais com acessório para montagem em parede (RT-14/6, RT-14/7, RT-15/6, RT-15/7).

Gaveta para insectos de limpeza fácil  
Luz UV para atrair insectos  
Todos os modelos funcionam utilizando tubos de luz negra especial (BL)  
Partes plásticas resistentes a UV  
Material de fabrico: ABS resistente às chamas, Alumínio pintado electrostaticamente



### ELECTROCUTOR DE INSECTOS COM GRELHA DE ALTA VOLTAGEM

MODELO	DESCRIÇÃO	CÓDIGO	PREÇO
RT-11	Electrocutor de insectos - Lâmpada BL 2 x 8W	925011000	153,50€

### ELECTROCUTOR DE INSECTOS COM GRELHA DE ALTA VOLTAGEM

MODELO	DESCRIÇÃO	CÓDIGO	PREÇO
RT-12	Electrocutor de insectos - Lâmpada BL 2 x15W	925012000	217,50€
A-1024	Grelha de protecção (transparente) para RT-12	801822012	12,40€



### ELECTROCUTOR INSECTOS, GRELHA DE ALTA VOLTAGEM (INSTALAÇÃO EM PAREDE )

MODELO	DESCRIÇÃO	CÓDIGO	PREÇO
RT-14	Electrocutor de insectos - Lâmpada BL 3 x20W	925014000	348,00€
RT-14/2	Electrocutor de insectos - Lâmpada BL 2 x 20W	925014001	328,00€

### ELECTROCUTOR DE INSECTOS COM GRELHA ALTA VOLTAGEM

MODELO	DESCRIÇÃO	CÓDIGO	PREÇO
RT-15	Electrocutor insectos - Lâmpada BL 3 x 40W	925015000	564,00€

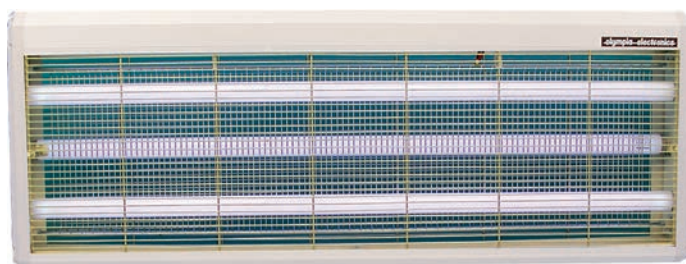

Os electrocutores de insectos são utilizados para exterminar vários insectos incomodativos. Possuem tubos especiais de luz negra utilizados para atrair a distâncias consideráveis. Podem ser utilizados em qualquer área onde existam insectos.

Possuem no interior uma grelha de alta voltagem (2 a 4 KV dependendo do modelo) e uma grelha exterior para protecção de pessoas, animais e pássaros que possam chegar perto. Protegem-nos de vários tipos de insectos (mosquitos, moscas, melgas, etc...) que são atraídos pela luz sem recurso a qualquer tipo de químicos. A gaveta de recolha incorporada pode ser facilmente removida e limpa.





Design moderno.

Amigo do ambiente.

Instalação e limpeza fácil.

Fabrico de acordo c/ os regulamentos HACCP.

Não utiliza grelhas de alta voltagem.

Possibi.colocação em mesa(acessório especial)

Arm.cola,resist. a raios UV,e altas temperaturas

Material fabrico:ABS resistente às chamas,  
alumínio pintado electrostaticamente

Produzido de acordo com: EN60335.02.59

UV para atrair insectos

Na indústria da alimentação, restauração e bebidas é obrigatório aderir ao regulamento HACCP, segundo o qual é proibido a utilização de químicos e grelhas de alta voltagem no fabrico de armadilhas para insectos. Em substituição da grelha de alta voltagem, é utilizada uma placa de cola especial. A respectiva legislação do Conselho Europeu é TL/195/97-CE93/43 de 96/3 de 14 de Junho 1993. Esta legislação específica é obrigatória para toda a indústria onde há manuseamento de alimentos, assim como a indústria da restauração (restaurantes, doçarias, confeitarias, padarias, talhos e supermercados, etc)

O produto RT-1 combina a sua utilização para insectos e luz nocturna. A sua luz azul possui uma frequência especial que atrai insectos e possui uma folha especial substituível. A área de alcance é sensivelmente de uma sala.

**ARMADILHA DE COLA PARA INSECTOS COM COLA da série “DELUXE FLYTRAP”**

MODELO	DESCRIÇÃO	CÓDIGO	PREÇO
RT-30	Armadura de cola - Lâmpada BL 2 x 8W (cobertura 40 sq.m)	925030000	110,40€
RT-30/SL	Arma.de cola - Lâmpada BL 2 x 8W (cobertura 40 sq.m), cinza prata	925030100	128,50€
RT-30/HACCP	Armadura de cola - Lâmpada BL/HACCP 2 x 8W (cobertura 40 sq.m)	925030200	168,50€
RT-30/HACCP/SL	Arma.cola-Lâmp.BL/HACCP 2x8W (cobertura 40 sq.m),cinza prata	925030300	170,00€
RT-36	Armadura de cola - Lâmpada PL 26W BL (cobertura 60 sq.m)	925036000	126,00€
RT-36/SL	Armadura de cola - PL 26W BL (cobertura 60 sq.m), cinza prata	925036100	148,00€



**PEÇAS DE SUBSTITUIÇÃO da série “DELUXE FLYTRAP”**

MODELO	DESCRIÇÃO	CÓDIGO	PREÇO
A-1030	Grelha para «Deluxe Fly» (para uso externo)	980103000	11,50€
A-1046	Placa de cola para “Deluxe Fly” (6 peças)	927104600	19,50€
A-1048	Placa de cola para “Deluxe Fly” (12 peças)	927104800	34,50€

**ARMADILHAS DE COLA PARA INSECTOS da série “FOODY’S FLYTRAP”**

MODELO	DESCRIÇÃO	CODIGO	PREÇO
RT-22	Armadilha de cola - Lâmpada BL 2x15W (cobertura 80 sq.m)	925022000	256,00€
RT-22/HACCP	Armadilha de cola - Lâmpada BL/HACCP 2x15W (cobertura 80 sq.m)	925022100	293,00€
RT-24	Armadilha de cola - Lâmpada BL 4x15W (cobertura 160 sq.m)	925024000	291,00€
RT-24/HACCP	Armadilha de cola - Lâmpada BL/HACCP 4x15W(cobertura 160 sq.m)	925024100	375,00€



**PEÇAS DE SUBSTITUIÇÃO da série “FOODY’S FLYTRAP”**

MODELO	DESCRIÇÃO	CÓDIGO	PREÇO
A-1050	Placa de cola para RT-22 (1 peça)	927105000	11,30€
A-1052	Placa de cola para RT-24 (dupla face)	927105200	13,30€
A-1024	Grelha protecção (transparente) para RT-22 e RT-24	801822012	13,00€

**ARMADILHAS DE COLA PARA INSECTOS da série “PROFESSIONAL DELUXE FLYTRAP”**

MODELO	DESCRIÇÃO	CÓDIGO	PREÇO
RT-50/HACCP	Armadilha cola - Lâmpada BL/HACCP 1 x 20W (cobertura 80 sq.m)	925050000	246,00€
RT-52/HACCP	Armadilha cola - Lâmpada BL/HACCP 2 x 20W (cobertura 160 sq.m)	925052000	430,00€
RT-60/HACCP	Armadilha cola - Lâmpada BL/HACCP 1 x 40W (cobertura 180 sq.m)	925060000	348,00€
RT-62/HACCP	Armadilha cola- Lâmpada BL/HACCP 2 x 40W (cobertura 360 sq.m)	925062000	635,00€



**PEÇAS DE SUBSTITUIÇÃO da série “PROFESSIONAL DELUXE FLYTRAP”**

MODELO	DESCRIÇÃO	CÓDIGO	PREÇO
A-1066	Placa de cola para “Deluxe Fly” (6 peças)	927106600	39,00€
A-1068	Placa de cola para “Deluxe Fly” (12 peças)	927106800	70,00€

BS-1632, BS-1634, BS-1636. Painéis de detecção de incêndio com 2,4 e 6 zonas respectivamente. Possuem controlos e indicações de funcionamento uniformes. Possuem 2 saídas para sirenes, relé de alarme, saída para operador telefónico e um relé por zona.

BS-1610. Painel de detecção de incêndio de 10 zonas com o mesmo funcionamento e indicações dos painéis anteriores. Oferecem 2 saídas para sirenes, um relé de alarme, saída de falha e 2 relés independentes respectivamente.

BS-633. Painel de detecção de incêndio com 2 zonas para sensores, uma zona para botoneira, uma saída para sirene e uma saída para extintor de incêndio com atraso programável (adequados para postos de gasolina).

Para funcionamento dos painéis é necessário uma bateria A-986 (12V/7Ah). Todas as funções e indicações estão de acordo com a norma europeia EN 54.

BS-1634/EXT. Painel de detecção de incêndio com 2 zonas, uma zona detecção de gás e extinção manual, adequados para zonas comerciais.

BS-1628-1. 2 Painel extinção de zona, com zona para cancelamento manual de extinção. A saída de extinção é controlável e pode ser usada uma botoneira ou uma electroválvula. Além disso possui uma saída para sirene, uma para erro, 1 saída para painel de detecção de incêndio.



## PAINÉIS DE DETEÇÃO DE INCÊNDIO COM 2,3,4,6 E 10 ZONAS da série "FIRE SYS"

MODELO	DESCRIÇÃO	PREÇO
BS-1632	Painel de detecção de incêndio com relé independente por zona e relé AUX	319,50€
BS-1633	Painel de detecção de incêndio de zonas (para postos de gasolina)	421,50€
BS-1634	Painel de detecção de incêndio de 4 zonas c/relé independente por zona e relé AUXy	336,00€
BS-1634/EXT	Painel de detecção de incêndio de 4 zonas, 1 saída extintor (zona passagem)	446,00€
*BS-1636	Painel de detecção de incêndio de 6 zonas c/relé independente por zona e relé AUX	434,00€
BS-1610	Painel de detecção de incêndio de 10 zonas	738,00€



## PAINÉIS EXTINÇÃO DE INCÊNDIO

MODELO	DESCRIÇÃO	CÓDIGO	PREÇO
BS-627	Painel de extinção de incêndio um comando com 4 zonas	921627000	1220,00€
BS-628-1	Painel de extinção, com uma zona de cancelamento manual de extinção	921628001	247,00€

## PERIFÉRICOS DE DETEÇÃO DE INCÊNDIO - ACESSÓRIOS da série "FIRE SYS"



BS-50

MODELO	DESCRIÇÃO	CÓDIGO	PREÇO
BS-613	Carta com 4 relés de zona para painel BS-610	921613000	68,00€
BS-620	Unidade de aviso público	921620000	191,00€
BS-50	Microfone para BS-620	921050000	68,00€
A-632	Base metálica de encastrar para painéis da série "Fire Sys"	980163200	166,00€
A-986	Bateria chumbo-ácido Pb 12V/ 7Ah	603001270	48,00€





Alimen.18-30VDC(fumo,temperatura)11-30V DC (gás)  
Indicador de activação em LED  
Relés de activação(detecores de gás)

Prozuido de acordo com a norma europeia EN 54  
Temp.func.-20 a 60°C(-20 a 90°C BS-660-661-668)  
Humidade: até 95% de humidade relativa

BS-655, Detector óptico de fumo ( ou detector de partículas de fumo) é activado quando a taxa de obscurecimento causada pelo fumo exceder 3% por metro.  
BS-660. Detector de calor com base.

BS-661. Detector calor estanque (IP 65).  
BS-657, Detector de dupla tecnologia, pode ser usado para monitorizar uma área de 23-30 metros quadrados.



## DETECTORES DE FUMO, TEMPERATURA E GÁS



MODELO	DESCRIÇÃO	CÓDIGO	PREÇO
BS-655	Detector óptico de fumo com base	921655000	29,50€
BS-657	Detector de fumo e termodiferencial com base	921657000	92,50€
BS-660	Detector termodiferencial com base	921660000	49,50€
BS-668	Detector de temperatura 60 °C com base	921668000	50,50€
BS-668/90	Detector temperatura com base	921668090	50,50€
BS-659	Detector de chama com base	980165900	150,50€
Base-6024	Base com relé 24V para BS-655,BS-657,BS-660,BS-668	927600001	47,50€



## DETECTORES DE FUMO, TEMPERATURA E GÁS ESTANQUES



MODELO	DESCRIÇÃO	CÓDIGO	PREÇO	IP 65
BS-661	Detector termodiferencial estanque (IP 65)	921661000	81,50€	
BS-658	Detector monóxido carbono estan.(IP 65),11-30VDC (capac. p/ligação dupla)	980165800	508,50€	
BS-685	Detector LPG estanque (IP 65), com relé 10V-30DC	921685000	132,50€	
BS-686	Detector gás estanque (IP 65), gás natural com relé 10V-30DC	921686000	132,50€	



## DETECTORES FUMO E CALOR ANTI-EXPLOSIVO

MODELO	DESCRIÇÃO	CÓDIGO	PREÇO
BS-655/Ex	Detector óptico de fumo anti-explosivo	980165500	810,00€
BS-660/Ex	Detector termodiferencial anti-explosivo	980166002	716,00€

O detector BS-668 é activado quando a temperatura da área monitorizada é superior a 60 °C. Pode ser usado para monitorizar uma área de cerca de 50 metros quadrados.

BS-685 detector estanque (IP65) com relé, é activado quando o teor de gás (propano e butano ) na área monitorizada ultrapassa 5-15% do nível inferior de explosividade (L.E.L). O LED incorporado acende quando o detector é activado. O comando é dado com um relé de contacto.

A base 6024 tem um relé incorporado que é activado quando o detector emite um alarme. Pode ser usada para controlar dispositivos (sirenes) que devem ser activados em caso de alarme.

# SIST. DET. INCÊNDIO ANALÓGICO ENDEREÇÁVEL

## CONTROLO DETECÇÃO INCÊNDIO ENDEREÇÁVEL

### PAINEL 1 A 8 LOOP da série "ADDRESS FIRE"



#### PAINEL CONTROLO DET. INC. ANALÓGICO ENDEREÇÁVEL 1 A 8 LOOP da série "ADDRESS FIRE"

MODELO	DESCRIÇÃO	PREÇO
BSR-2104	Painel deteção inc.endereçável analógico 2 loops/96 zonas	3550,00€
BSR-2114	Painel deteção inc. endereçável analógico 4 loops/96 zonas	5165,00€



MODELO	DESCRIÇÃO	PREÇO
BSR-2140	Dispositivo de expansão c/2 loops p/painel endereçável BSR-21XX	1601,00€
BSR-2141	Dispositivo de expansão c/ 4 loops p/painel endereçável BSR-21XX	2328,00€
BSR-2142	Impressora térmica para BSR-21XX	875,00€
BSR-2000	Painel repetidor para BSR-21XX	1534,00€
BSR-8017	Unidade endereçável I/O	183,00€
BSR-5032	Sirene com farol endereçável IP 42	160,00€
BSR-5032/WP	Sirene endereçável com sinalizador estanque IP 65	190,00€
A-2100	Software e cabo USB para BSR-21xx	77,00€
BOX-2100/WP	Caixa metálica estan. p/painel det. incêndio BSR-2104 & BSR-2114	1345,00€



#### PROGRAMA ESPECIALIZADO PARA TRATAMENTO SISTEMAS DETECÇÃO DE FOGO POR UM PC.

A série CMI inclui programas para funcionamento independentes e suporta painel individual ou de rede.  
A série BMS inclui os programas necessários para operar o sistema com um edifício central de gestão.

#### Software BMS & CMI para painéis BSR-2104 & BSR-2114

MODELO	DESCRIÇÃO	PREÇO
BMS-1001	Software básico para ligação BSR-2xxx com Porta	S/CONSULTA
BMS-1204	Software para ligação BSR-21xx com protocolo BACnet	S/CONSULTA
BMS-1202	Software para ligação BSR-21xx com protocolo Modbus I	S/CONSULTA
BMS-1203	Software para ligação BSR-21xx com protocolo OPC	S/CONSULTA
CMI-1001	Software monitor BSR-21xx	S/CONSULTA
CMI-1202	Modbus protocolo para CMI-1001	S/CONSULTA
CMI-1203	OPC protocolo para CMI-1001	S/CONSULTA
CMI-1204	BACnet protocolo para CMI-1001	S/CONSULTA
BMS-485	Dispositivo para ligação BSR-21xx com um PC	S/CONSULTA



## PAINEL DET. INCÊNDIO ENDEREÇÁVEL 1 LOOP série «ADDRESS FIRE»

O painel de deteção de incêndio BSR-1116 é fabricado com as normas Europeias EN 54-2 e EN 54-4. É apropriado para médias e grandes instalações como hotéis, centros comerciais e fábricas. Cada dispositivo ligado ao painel possui o seu próprio endereço e um nome com 16 caracteres que é definido pelo utilizador. O loop do painel pode aceitar até 150 dispositivos endereçáveis e capacidades de conexão de dispositivo convencional. Todos os dispositivos podem ser divididos em 16 zonas sem qualquer restrição. O painel possui 2 saídas independentes para sirene programáveis, onde poderão ser ligadas sirenes e campainhas convencionais.

BSR-8018. Unidade entrada-saída endereçável. Possui uma entrada que é monitorizada para condições de circuito aberto e curto-circuito e uma saída de relé de 1A/30V totalmente programável a partir do painel. Podem ser ligadas ao loop até 16 destas unidades. Cada unidade ocupa 2 endereços, um para entrada e outro para o relé.

BSR-5031. Sirene de incêndio endereçável com sinalizador. Estas sirenes são alimentadas pelo loop e cada loop pode aceitar até 16 sirenes.

BSR-6558. Impressora térmica apropriada para ligação com o painel endereçável BSR-1116.



#### PAINEL DE DETECÇÃO DE INCÊNDIO COM 1 LOOP da série "ADDRESS FIRE"

MODELO	DESCRIÇÃO	PREÇO
BSR-1116	Painel deteção incêndio endereçável c/1 loop analógico, 16 zonas	1711,00€
BSR-5031	Sirene de incêndio endereçável com sinalizador, 100dB	163,00€
BSR-5031/WP	Sirene incêndio endereçável estanque IP65,c/sinalizador 100dB	190,00€
BSR-6558	Impressora térmica para BSR-1116	1308,00€
BSR-8018	Unidade entrada / saída endereçável com relé auxiliar	184,00€
A-1100	Software para BSR-1116 e cabo USB	77,00€





## DISPOSITIVOS DE DETEÇÃO DE INCÊNDIO ENDEREÇÁVEIS COMPATÍVEIS COM OS PAINÉIS

BSR-2104, BSR-2114 & BSR-1116

BSR-6055/A. Sensor óptico de fumo endereçável. Possui uma câmara interna «inteligente» com um transmissor e receptor especiais. O sensor envia continuamente informação digital ao painel sobre a quantidade de fumo. O painel, utilizando algoritmos especiais, decide quando emitir o alarme. O sensor possui uma base de ligação especial e micro-interruptores que são utilizados para definir o endereço.

BSR-6057/A. Detetor óptico de fumo endereçável / detetor termodiferencial. ( A mesma base do BSR-6055A)

BSR-6060/A. Sensor termodiferencial endereçável. Possui um sensor especial de temperatura que oferece uma saída dependendo da temperatura da área monitorizada. O micro processador incorporado calcula a taxa de aumento da temperatura e envia informação digital ao painel. O sensor possui uma base de ligação especial e micro-interruptores que são utilizados para definir o endereço.

BSR-5036/A. Botoneira endereçável. Quando activada, esta botoneira informa o painel da precisa localização da ocorrência e em simultâneo acende o

LED incorporado. Possui micro-interruptores que são utilizados para definir o endereço.

BSR-8013/A. Controlador endereçável para dispositivos convencionais. Esta unidade permite que o sistema aceite uma nova zona ou pré-instalação de sensores convencionais e botoneiras. Quando o painel emite um comando «Sirene Silence» o BSR-8013/A e o sensor que emitiram o alarme permanecerão activados para que sejam facilmente encontrados. Um comando «Reset» reporá os sensores no seu funcionamento normal. Cada loop pode aceitar até 10 dispositivos.

BSR-8019/A. Unidade endereçável de entrada com relé. É utilizada para ligar detectores de gás (ex. BS-685 e BS-686) no loop. Possui uma entrada que é completamente monitorizada para condições de circuito aberto e curto-circuito, e um relé (1A/30V) activado após o reset no painel.

BSR-7070/A. Isolador de linha. É colocado entre outras unidades endereçáveis e isola qualquer curto-circuito que possa acontecer nos cabos. Até 32 destes dispositivos podem ser conectados no loop.

## DISPOSITIVOS DE DETEÇÃO DE INCÊNDIO ENDEREÇÁVEIS



Base-6024/SB

MODELO	DESCRIÇÃO	CÓDIGO	PREÇO
BSR-5036/A	Botoneira endereçável	921503602	94,00€
BSR-5036/A/WP	Botoneira endereçável estanque IP 65	921503603	158,00€
BSR-5072	Detetor remoto LED (vermelho)	921507200	26,00€
BSR-6055/A	Sensor óptico de fumo endereçável	921605502	94,00€
BSR-6057/A	Detetor endereçável óptico fumo/detector termodiferencial	921605700	101,00€
BSR-6060/A	Sensor termodiferencial endereçável	921606002	86,00€
BSR-7070/A	Isolador de linha endereçável	921707001	155,00€
BSR-8013/A	Controlador endereçável de detector convencional	921801301	193,00€
BSR-8019/A	Unidade endereçável de entrada com relé	921801901	193,00€
Base-6024/SB	Base para detetor endereçável com sirene e farol	921602400	71,00€
BSR-7071/A	Isolador de linha endereçável com base	921707100	79,00€

BSR-5036/A



## ACESSÓRIOS PERIFÉRICOS

MODELO	DESCRIÇÃO	CÓDIGO	PREÇO
A-485	Amplificador de sinal para RS-485	980148500	1076,00€

BSR-5036/A/WP



BSR-6055/A



BSR-6057/A  
BSR-6060/A



BSR-7071/A



A-485



BSR-7070/A

DISPOSITIVOS PERIFÉRICOS  
DETEÇÃO INCÊNDIOolympia<sup>TM</sup>  
electronics

SAFETY &amp; SECURITY SYSTEMS



## DISPOSITIVOS DE AVISO E INDICAÇÃO PARA SISTEMAS DE DETEÇÃO DE INCÊNDIO

MODELO	DESCRIÇÃO	CÓDIGO	PREÇO
BS-528	Sinalizador de alarme	921528000	93,00€
BS-527	Armadura indicação escrava com besouro 12-24VDC	921527000	57,00€
BS-542	Sirene com sinalizador, 100dB (para BS-690, BS-691)	921542000	42,00€
BS-554	Megafone, sirene e sinalizador para BS-620	921554000	98,00€
BS-572	Detector remoto LED (vermelho)	921572000	18,00€
BS-576	Sinalizador com lâmpada incandescente	921576000	41,00€
BS-578	Sinalizador 12V DC com lâmpada XENON	921578000	75,00€
BS-579	Sinalizador 24V DC com lâmpada XENON	921579000	76,00€
BS-595	Campainha 6" para painéis de detecção de incêndio	921595000	65,00€

Etiqueta incluída  
na embalagem  
da BS-527**STOP**

BS-530/W, BS-530. Sirene (IP 42) para painéis de detecção de incêndio  
Tensão trabalho: 24 - 30 VDC.  
4 LEDs de alto rendimento.

BS-531/WP, BS-531. Sirene com sinalizador (IP 42) para painéis de detecção incêndio.  
Tensão trabalho: 24 - 30V DC.  
4 LEDs de alto rendimento.

MODELO	DESCRIÇÃO	CÓDIGO	PREÇO
BS-530	Sirene para painéis de detecção incêndio, 100dB, IP 42	921530000	57,00€
BS-531	Sirene com sinalizador p/painéis de detecção incêndio, 100dB, IP 42	921531000	55,00€
BS-530/WP	Sirene estanque para painéis de detecção de incêndio, 100dB IP65	921530003	66,00€
BS-531/WP	Sirene estanque c/sinalizador p/painéis detecção incêndio 100dB IP65	921531003	69,00€

BS-97, BS-98, BS-99. Estes dispositivos possuem um LED que pisca cada 8 segundos. Quando o detetor é ativado o besouro interno toca. Estes dispositivos podem ser instalados em escritórios, quartos, cozinhas, corredores, etc. Pode monitorizar uma área de cerca de 50m2.

MODELO	DESCRIÇÃO	CÓDIGO	PREÇO
BS-97	Detetor ótico de fumo 230V AC	980097000	28,50€
BS-98	Detetor ótico de fumo com bateria de 9V	980098000	28,00€
BS-99	Detetor ótico de fumo com dupla voltagem 230V AC, com bateria 9V	980099000	34,90€





**BS-419/KIT**



■ Central Alarme

MODELO	DESCRIÇÃO	PREÇO
BS-419/KIT	Central de Intrusão	380,00€

**BS-468/KIT**



■ Central Alarme

MODELO	DESCRIÇÃO	PREÇO
BS-468/KIT	Central de Intrusão	465,00€

■ Detetores

MODELO	DESCRIÇÃO	PREÇO
BS-405	Detetor Movimentos IR	50,00€
BS-409	Detetor Movimentos IR / Micro ondas	110,00€
BASE-401	Base para Detetor BS-405 e BS-409	6,00€
BS-360	Detetor Tecto 360° IR	87,00€
BS-660	Detetor Temperatura	50,00€
BS-655	Detetor ótico Fumos com base	30,00€
LD-12	Detetor	95,00€











# soflight

**Daylight**  
iluminação

Rua Moçambique, Nº 230  
Zona Industrial Ovar  
3880-106 Ovar - Portugal  
00351 256 579 250  
00351 256 579 259  
geral@soflight.com  
www.soflight.com